

[54] HOSE REEL

[76] Inventor: Bill P. P. Nederman, F.M. Franzen
Gate 2, S-252 33 Helsingborg,
Sweden

[**] Term: 14 Years

[21] Appl. No.: 471,705

[22] Filed: Mar. 3, 1983

[30] Foreign Application Priority Data

Sep. 8, 1982 [SE] Sweden 82-2138

[52] U.S. Cl. D8/358

[58] Field of Search D8/349, 354, 358, 359;
191/124, 122 R; 242/85, 96, 106, 77, 86;
339/147 C

[56] References Cited

U.S. PATENT DOCUMENTS

1,978,644 10/1934 Metler 191/12.4

2,499,909 3/1950 Fox 242/77
2,979,576 4/1961 Huber 339/147 C
4,220,293 9/1980 Gename 242/96
4,350,850 9/1982 Kovack et al. 191/12.2 R

Primary Examiner—B. J. Bullock
Attorney, Agent, or Firm—Schwartz, Jeffery, Schwaab,
Mack, Blumenthal & Evans

[57] CLAIM

The ornamental design for a hose reel, as shown and described.

DESCRIPTION

FIG. 1 is a front elevational view of a hose reel showing my new design;
FIG. 2 is a right side elevational view thereof;
FIG. 3 is a left side elevational view thereof;
FIG. 4 is a top plan view thereof;
FIG. 5 is a bottom plan view thereof;
FIG. 6 is a rear elevational view thereof;
FIG. 7 is a front perspective view thereof;
FIG. 8 is a rear perspective view thereof.

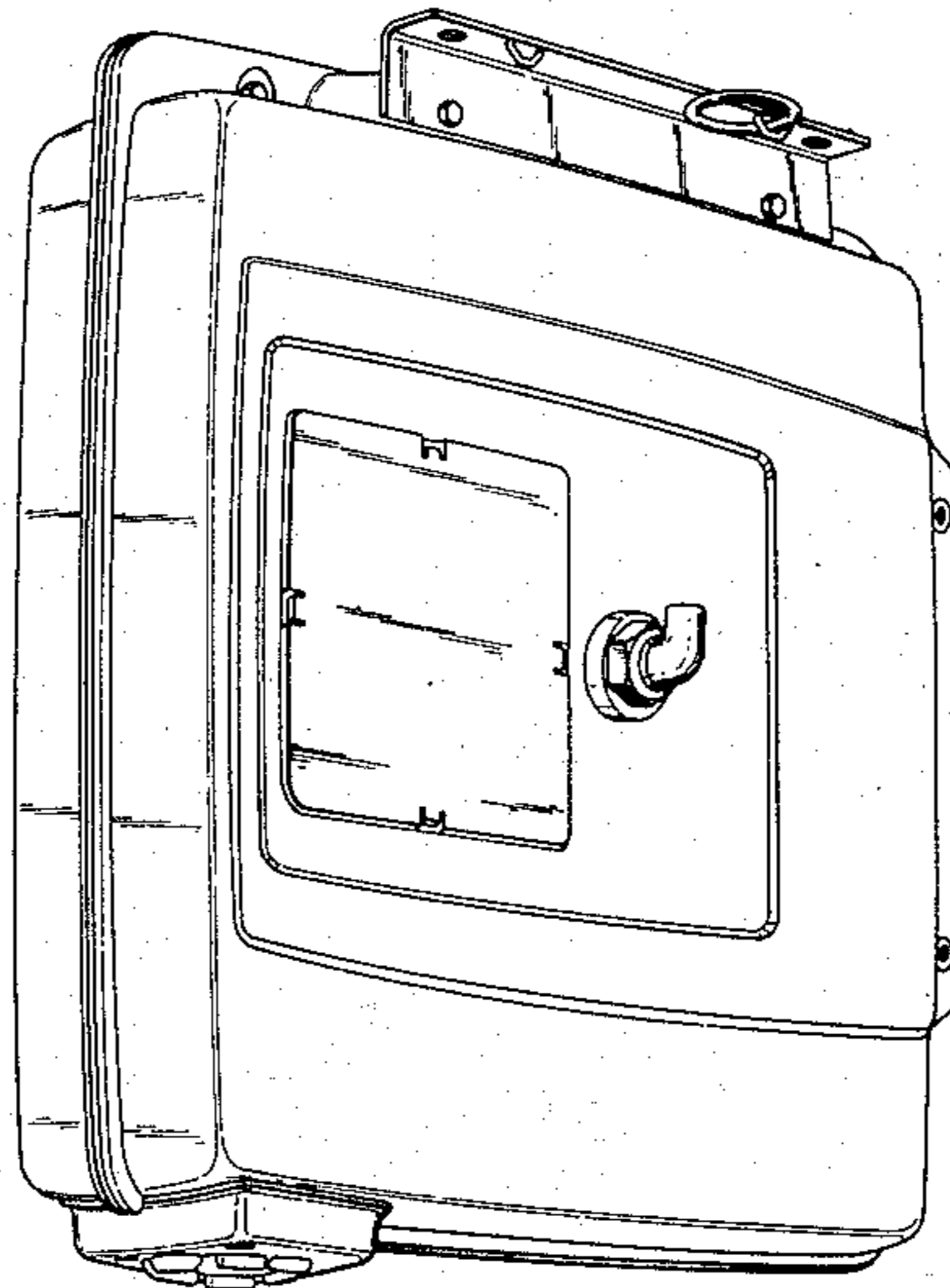

Fig. 1

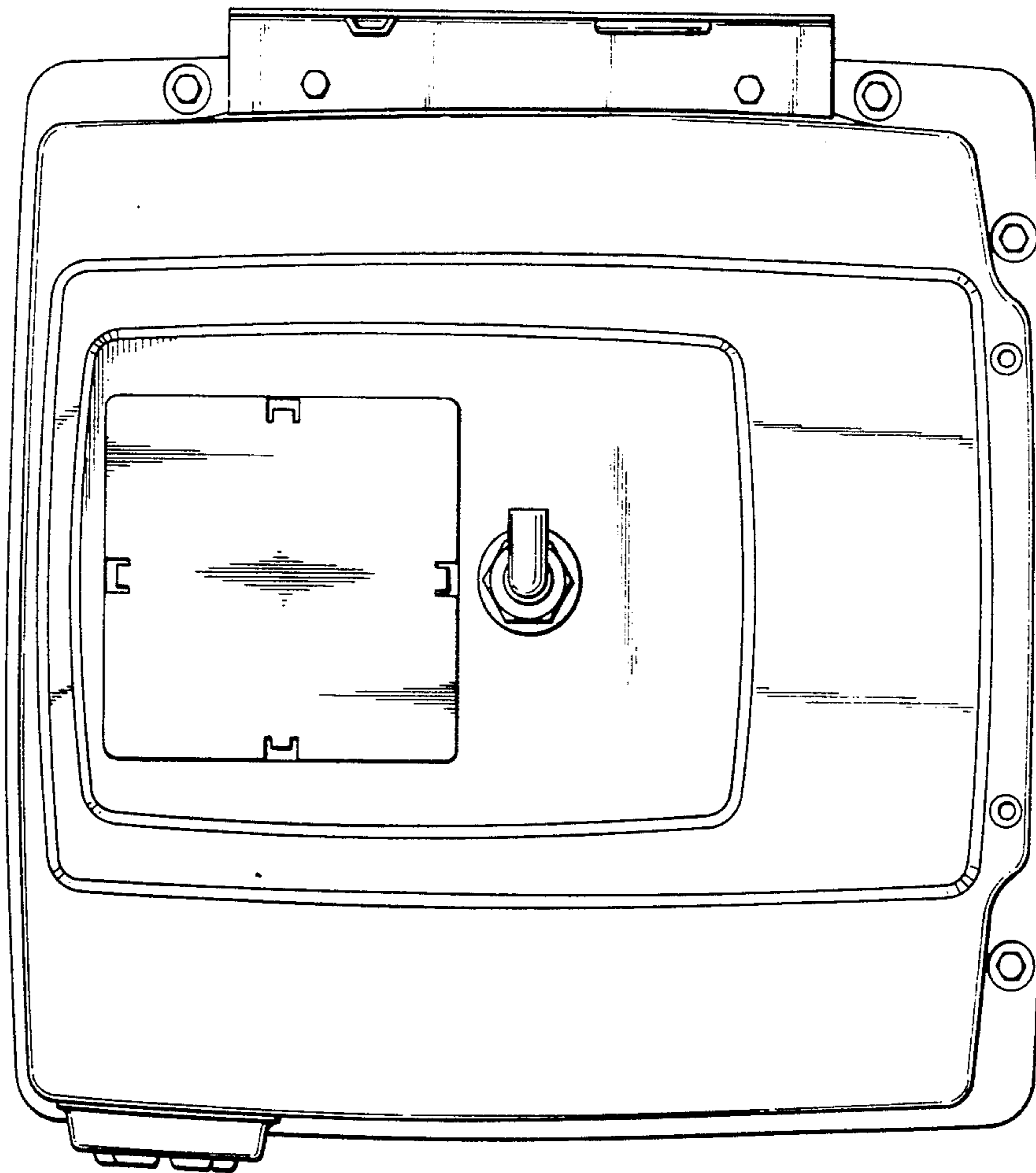

Fig. 2

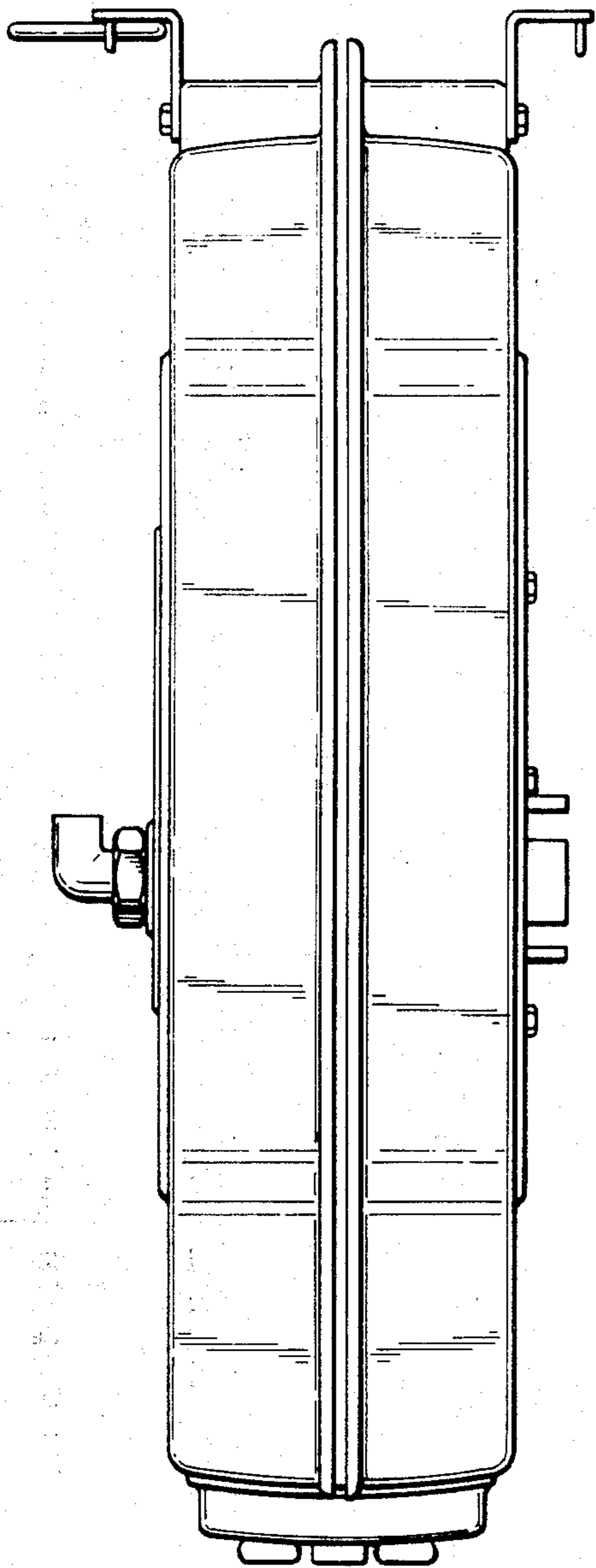
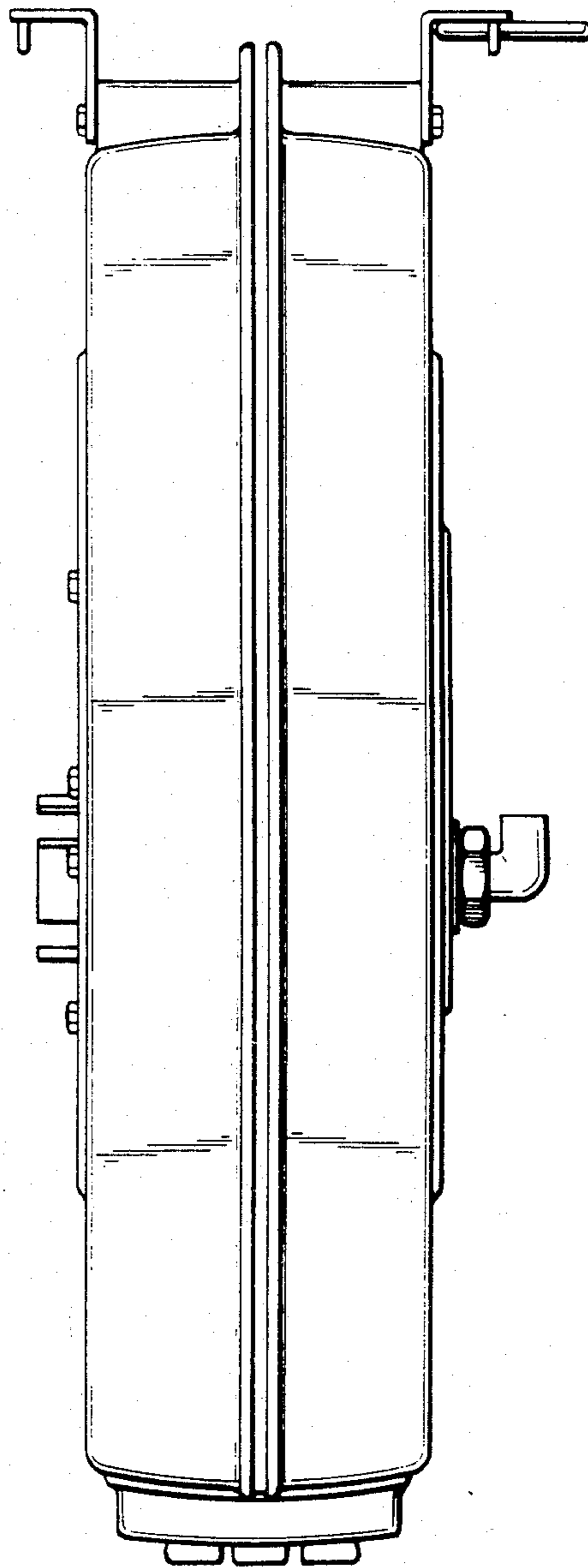

Fig. 3



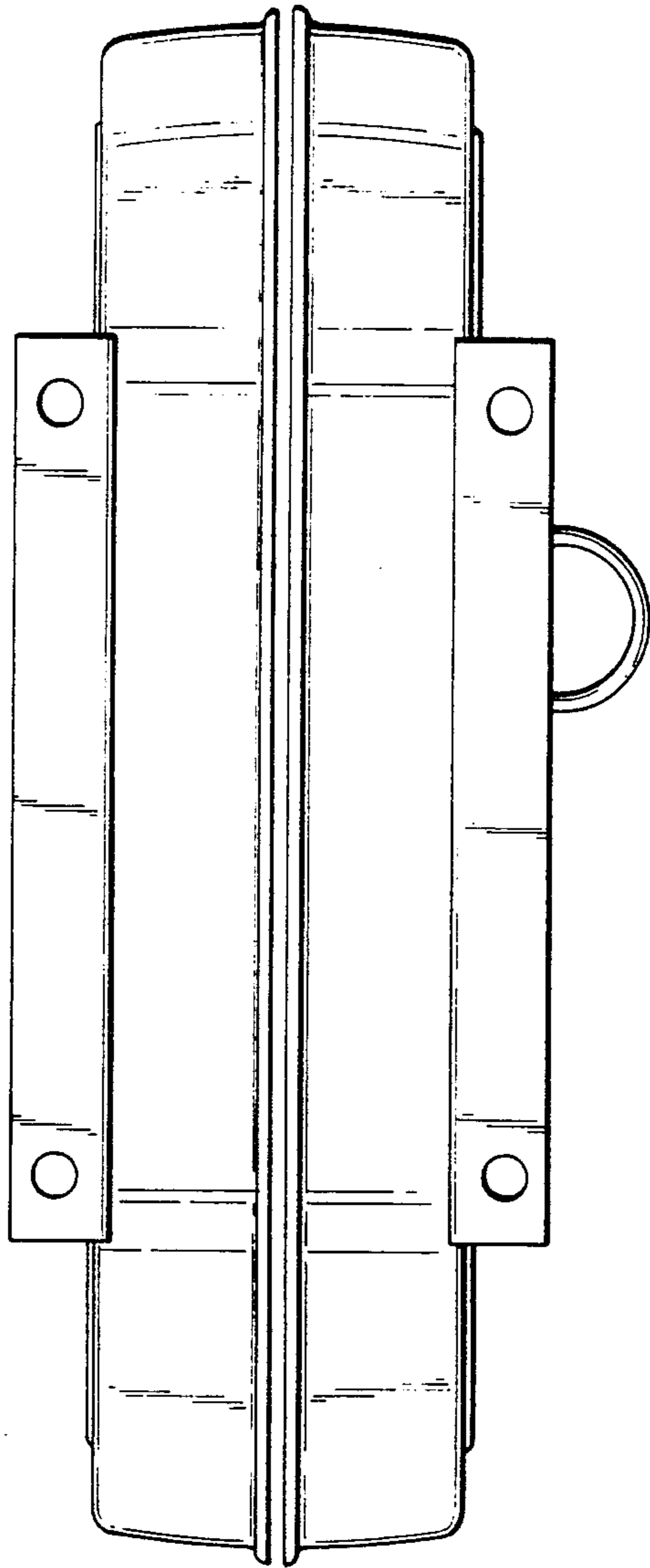

Fig. 4

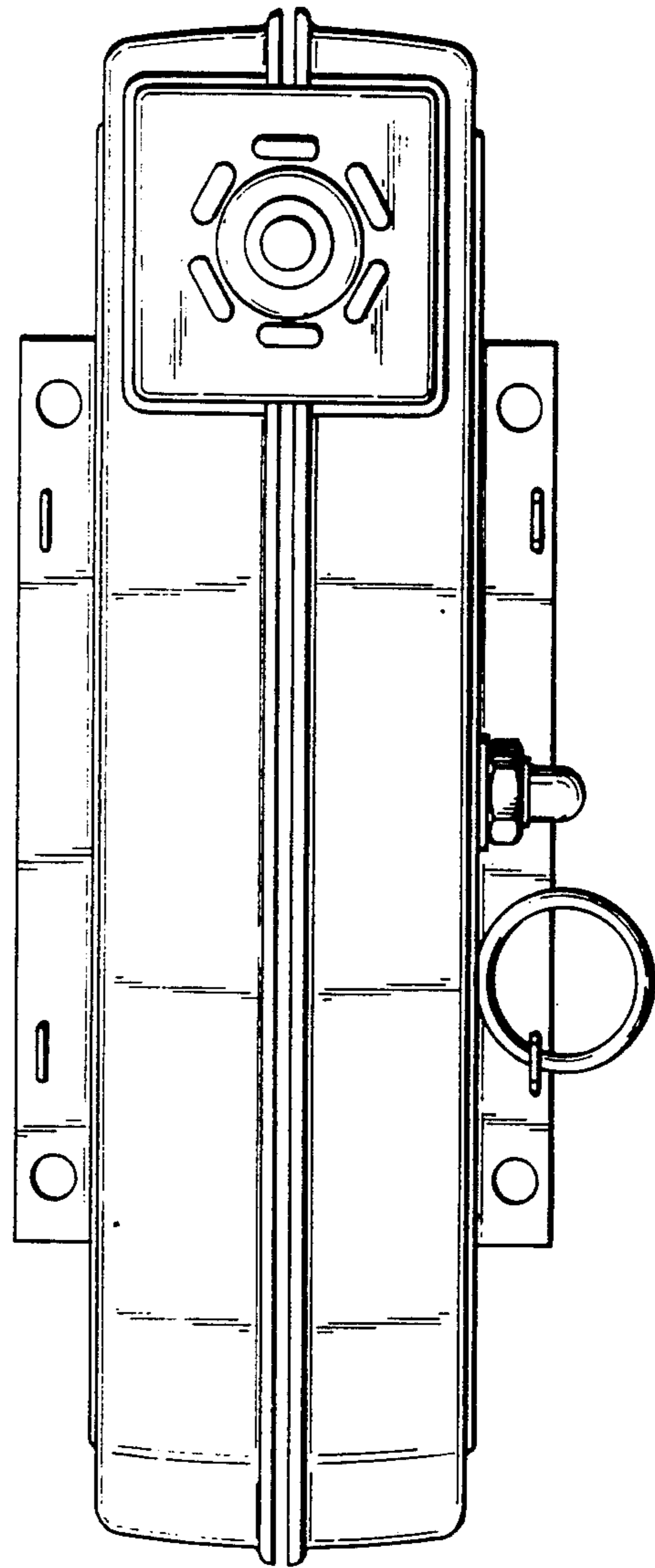

Fig. 5

Fig. 6

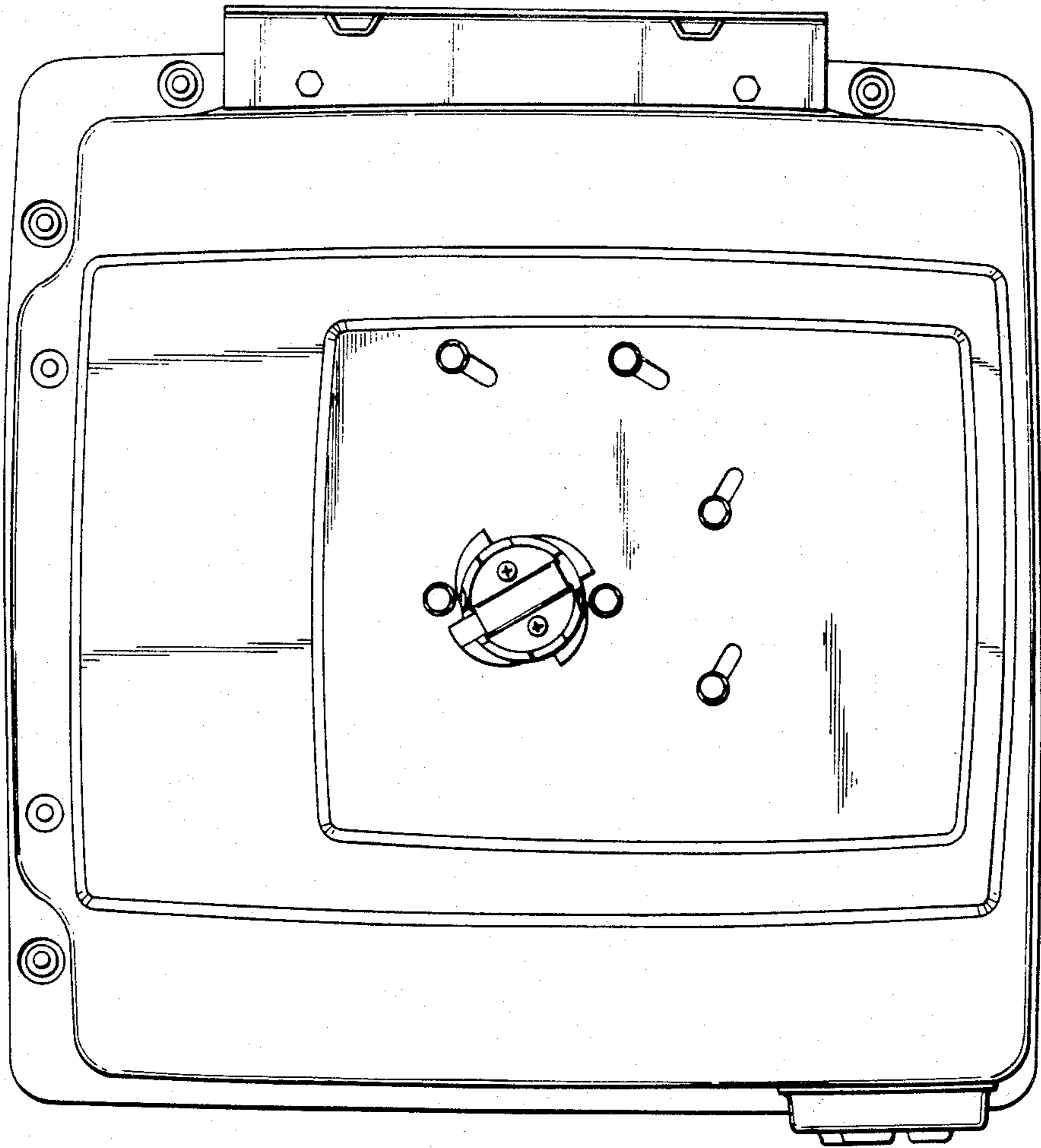

Fig. 7

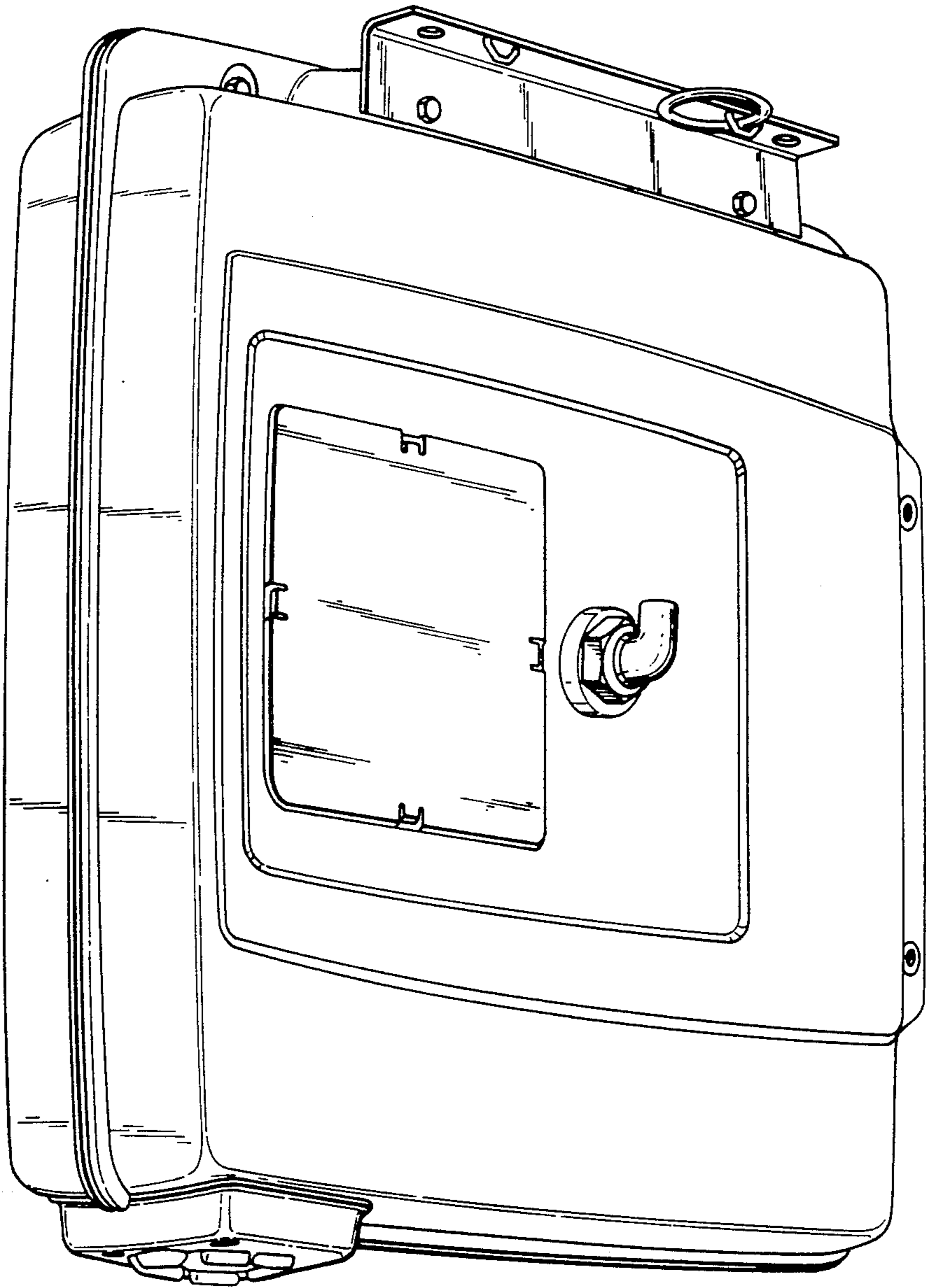

Fig. 8

