

[54] **DESIGN FOR A DISPLAY STAND**

[76] **Inventor: Keith W. Gray, 450 N. Mathilda Ave., Sunnyvale, Calif. 94086**

[\*\*] **Term: 14 Years**

[21] **Appl. No.: 429,770**

[22] **Filed: Sep. 30, 1982**

[52] **U.S. Cl. .... D6/455; D6/454; D6/459**

[58] **Field of Search ..... D6/20-29, 85**

[56] **References Cited**

**U.S. PATENT DOCUMENTS**

- D. 153,090 3/1949 Sexton ..... D6/20
- D. 174,172 3/1955 Foster ..... D6/20
- D. 224,060 6/1972 Larson ..... D6/23
- D. 233,087 10/1974 Martin ..... D6/145 X
- D. 240,070 5/1976 Mulvany ..... D6/20 X

D. 261,711 11/1981 Mulvihill ..... D6/145

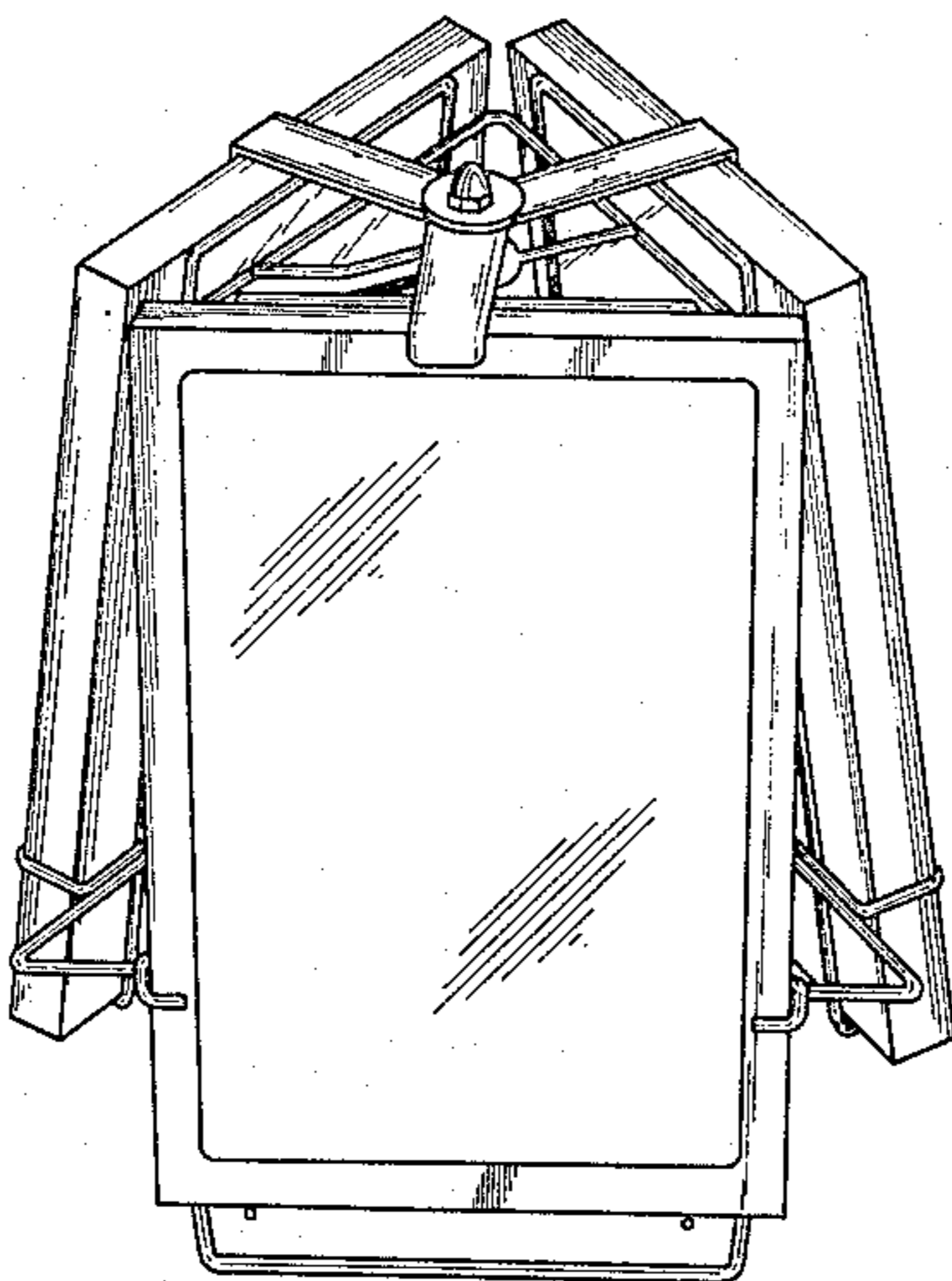
*Primary Examiner*—Bruce W. Dunkins  
*Attorney, Agent, or Firm*—C. Michael Zimmerman

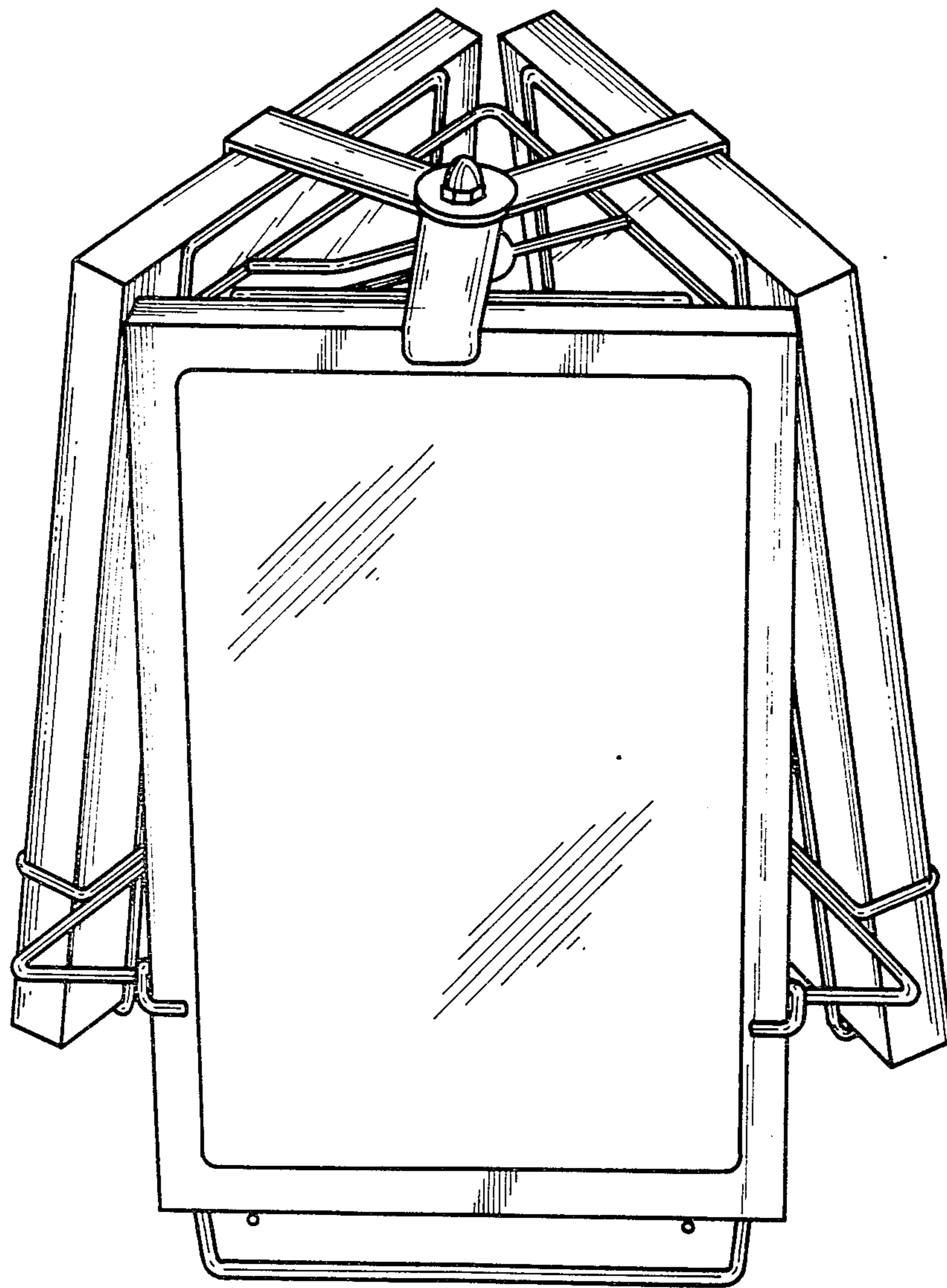
[57] **CLAIM**

The ornamental design for a display stand, as shown and described.

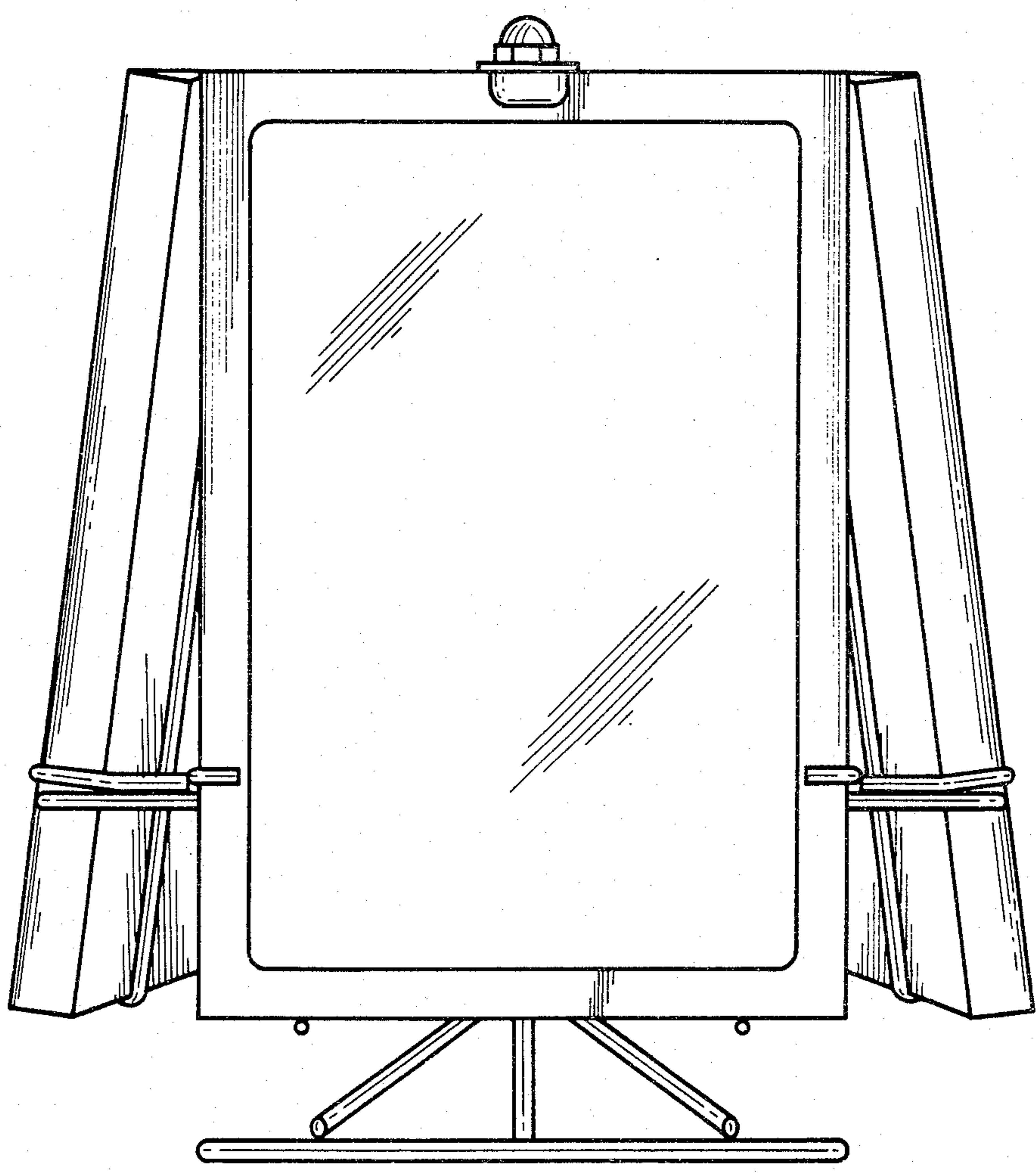
**DESCRIPTION**

FIG. 1 is a perspective view taken of the display case incorporating my design;  
FIG. 2 is a side elevational view;  
FIG. 3 is a side elevational view showing the unitary vertical support in greater detail;  
FIG. 4 is a side elevational view similar to FIG. 2 but pivoted slightly to the right;  
FIG. 5 is a top plan view of the display case of FIG. 1; and  
FIG. 6 is a bottom plan view of the display case of FIG. 1.

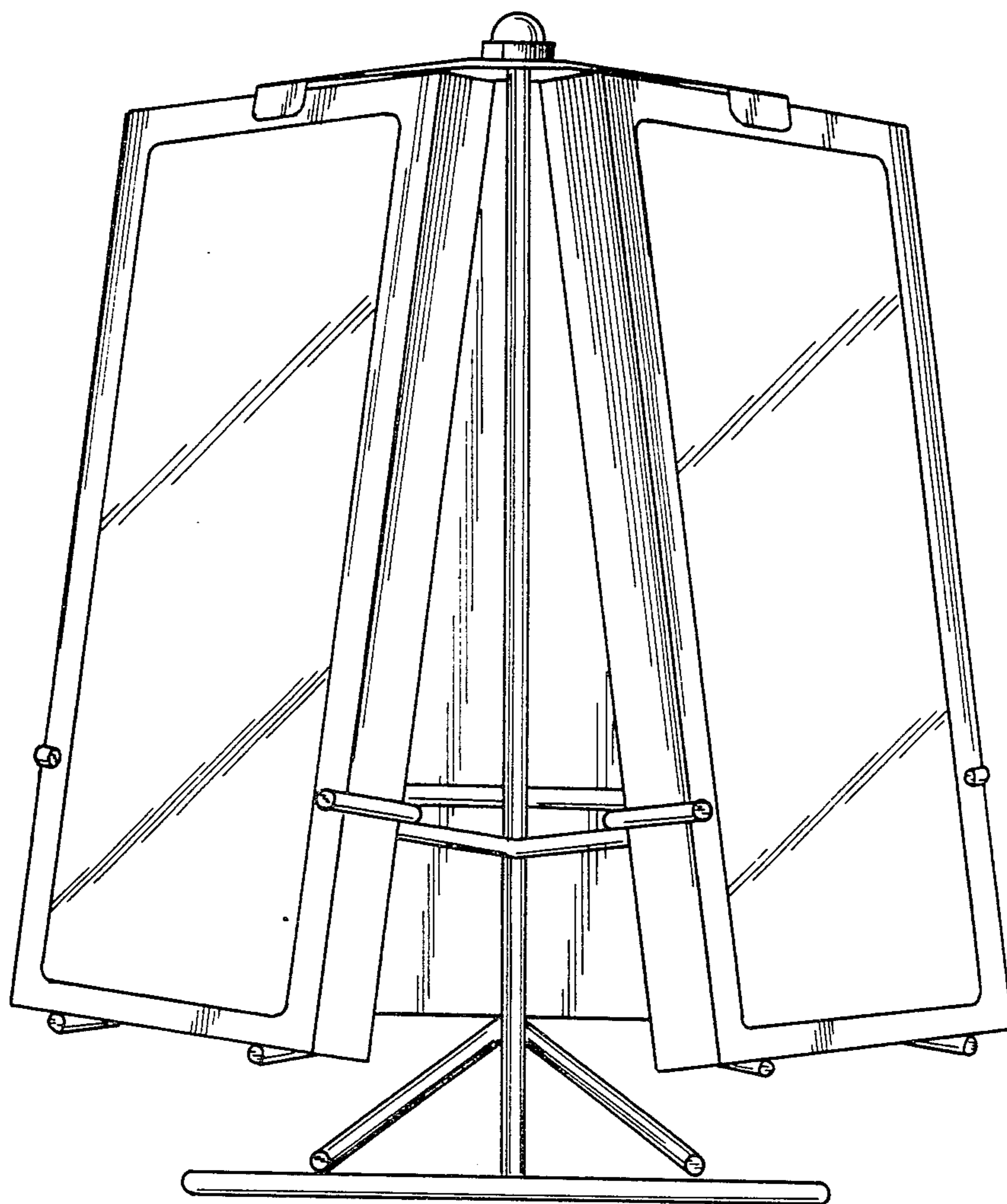




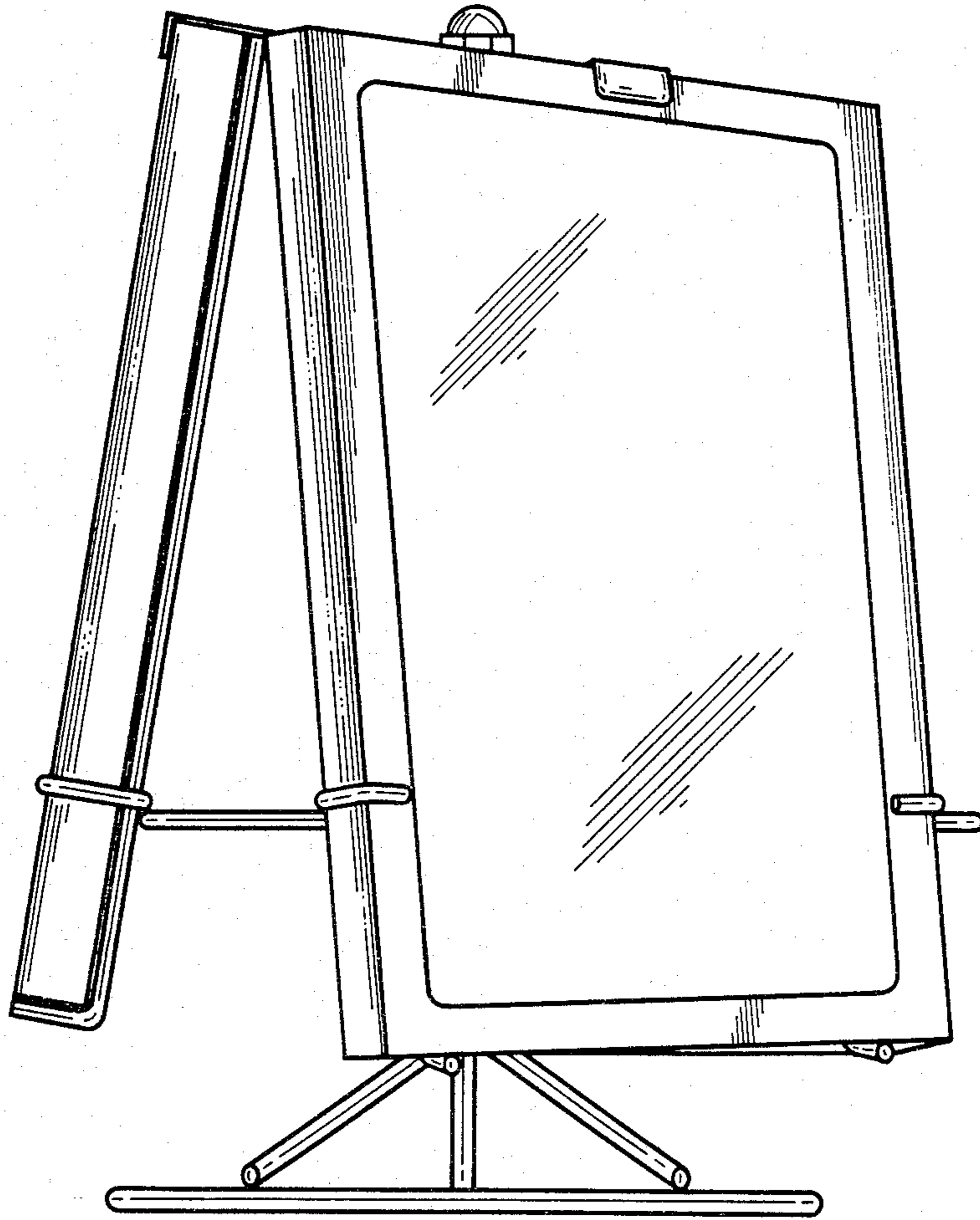
*Figure 1*



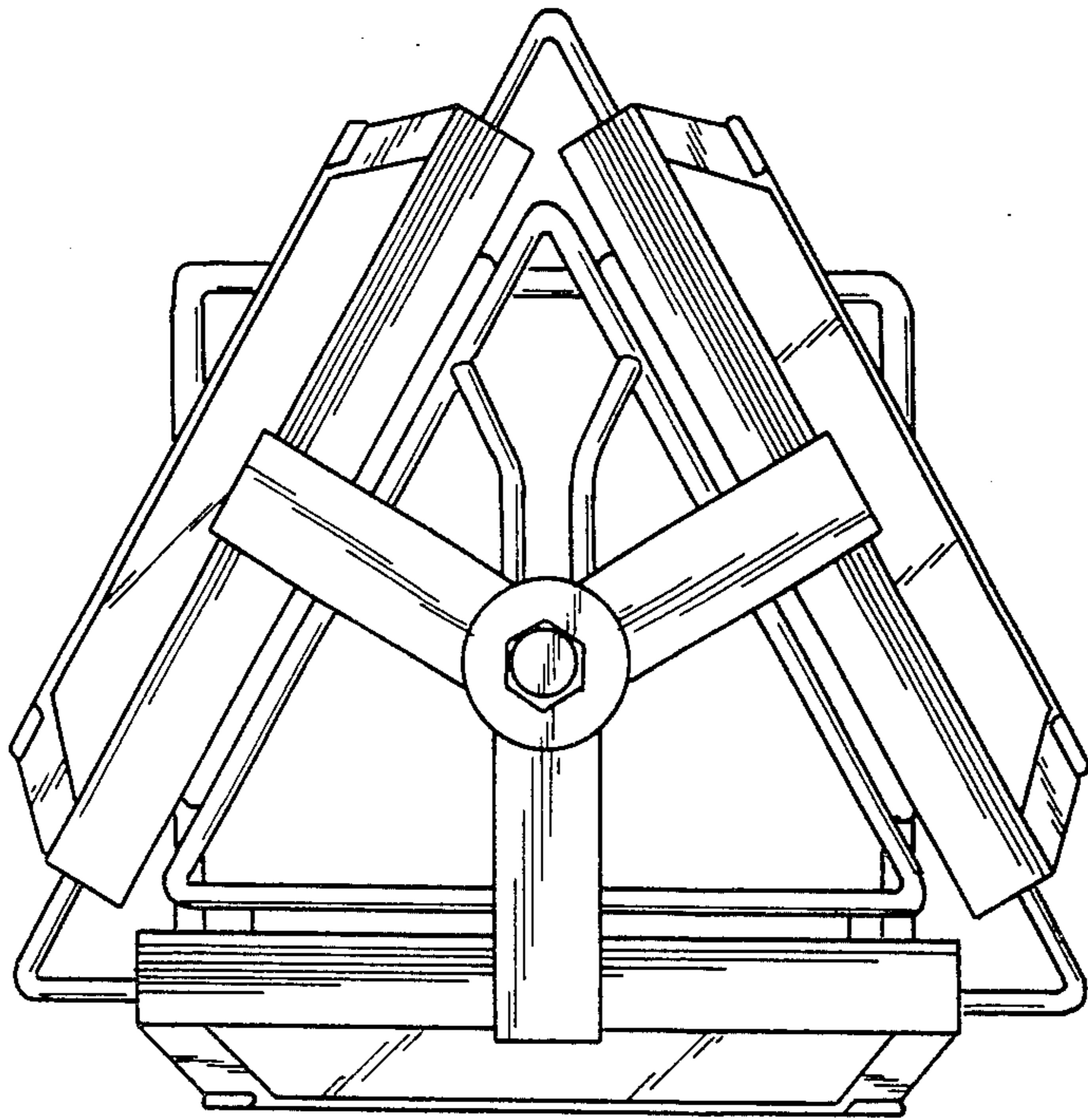
*Figure 2*



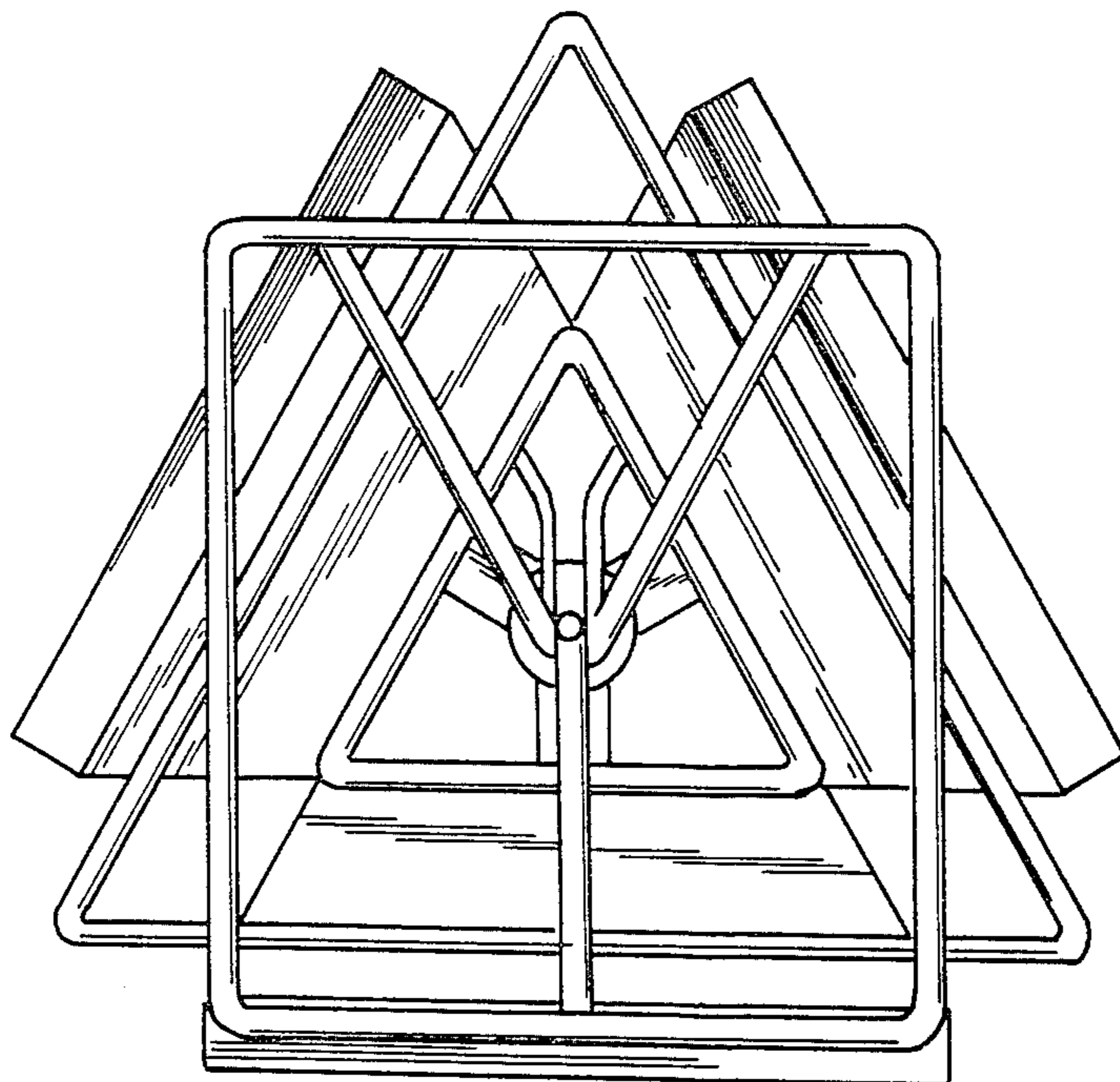
*Figure 3*



*Figure 4*



*Figure 5*



*Figure 6*