

[54] HAIR-DRYER

[76] Inventor: Johann J. Kerschgens,  
St.-Gotthard-Strasse 44, CH-6460  
Altdorf, Switzerland

[\*\*] Term: 14 Years

[21] Appl. No.: 514,508

[22] Filed: Jul. 18, 1983

[30] Foreign Application Priority Data

Jan. 17, 1983 [DE] Fed. Rep. of Germany ..... 4172  
[52] U.S. Cl. .... D28/13; D28/18  
[58] Field of Search ..... D28/9, 10, 12, 13, 15-18;  
34/96-101; 219/222; 132/9

[56] References Cited

U.S. PATENT DOCUMENTS

D. 228,370 9/1973 Ikejima ..... D28/13  
D. 239,884 5/1976 Nagelkerke ..... D28/13  
D. 243,368 2/1977 Nagelkerke ..... D28/13

OTHER PUBLICATIONS

Supplement To Washington Sunday Star-News,  
12/22/74, p. 12-Sears Men's Pro Dryer at top left.

Primary Examiner—Louis S. Zarfes  
Attorney, Agent, or Firm—Wigman & Cohen

[57] CLAIM

The ornamental design for a hair-dryer, substantially as shown and described.

DESCRIPTION

FIG. 1 is a right side elevational view of a hair dryer showing my new design;  
FIG. 2 is a top plan view thereof;  
FIG. 3 is a left side elevational view thereof;  
FIG. 4 is a bottom plan view thereof;  
FIG. 5 is a front elevational view thereof; and  
FIG. 6 is a rear elevational view thereof;  
FIG. 7 is a perspective view of a hair dryer showing a modified form of my new design;  
FIG. 8 is a right side elevational view of the form in FIG. 7;  
FIG. 9 is a top plan view of the form in FIG. 7;  
FIG. 10 is a left side elevational view of the form in FIG. 7;  
FIG. 11 is a bottom plan view of the form in FIG. 7;  
FIG. 12 is a front elevational view of the form in FIG. 7; and  
FIG. 13 is a rear elevational view of the form in FIG. 7;  
FIG. 14 is a right side elevational view of a hair dryer showing another modified form of my new design;  
FIG. 15 is a top plan view of the form in FIG. 14;  
FIG. 16 is a left side elevational view of the form in FIG. 14;  
FIG. 17 is a bottom plan view of the form in FIG. 14;  
FIG. 18 is a front elevational view of the form in FIG. 14; and  
FIG. 19 is a rear elevational view of the form in FIG. 14.

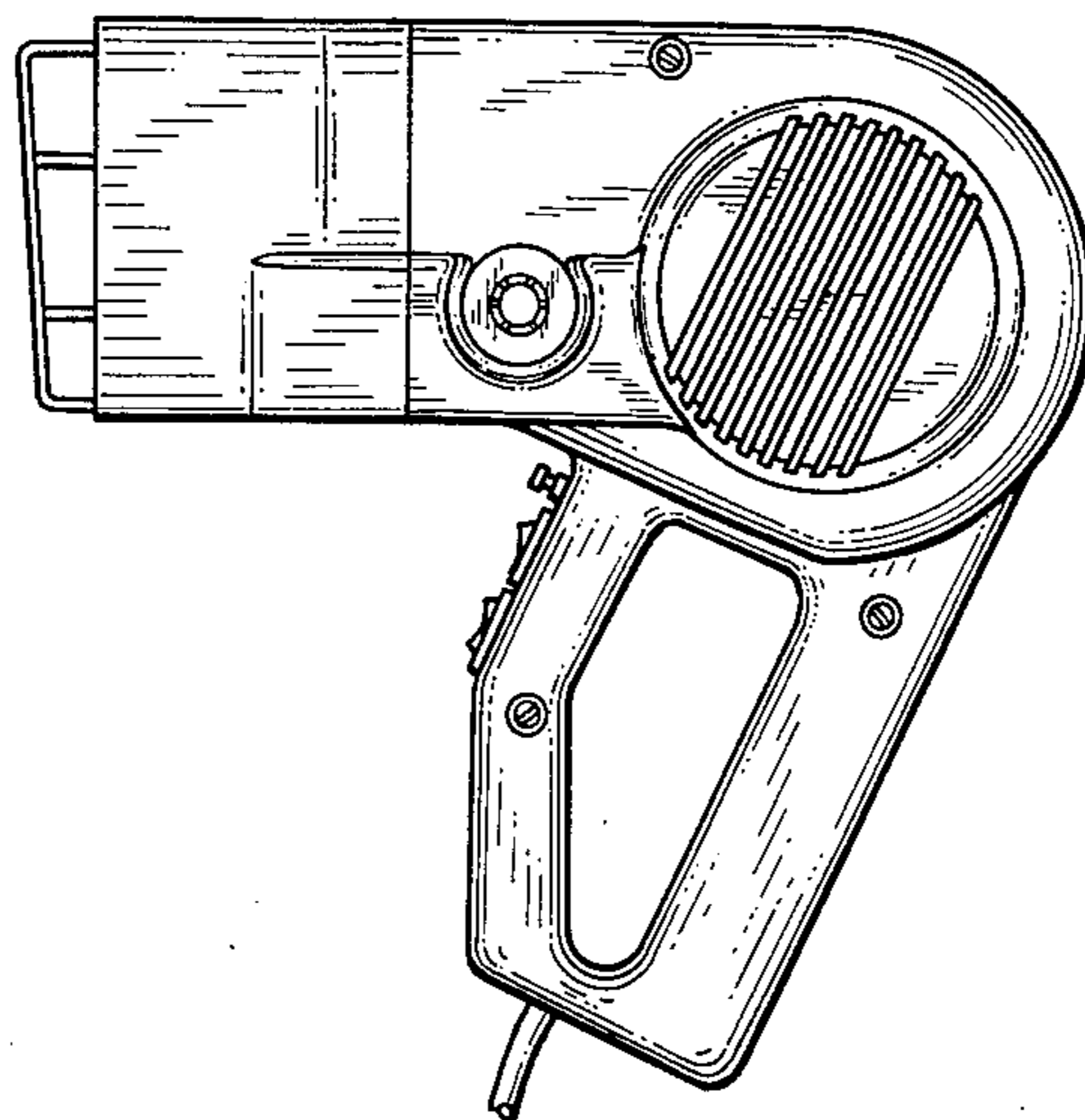
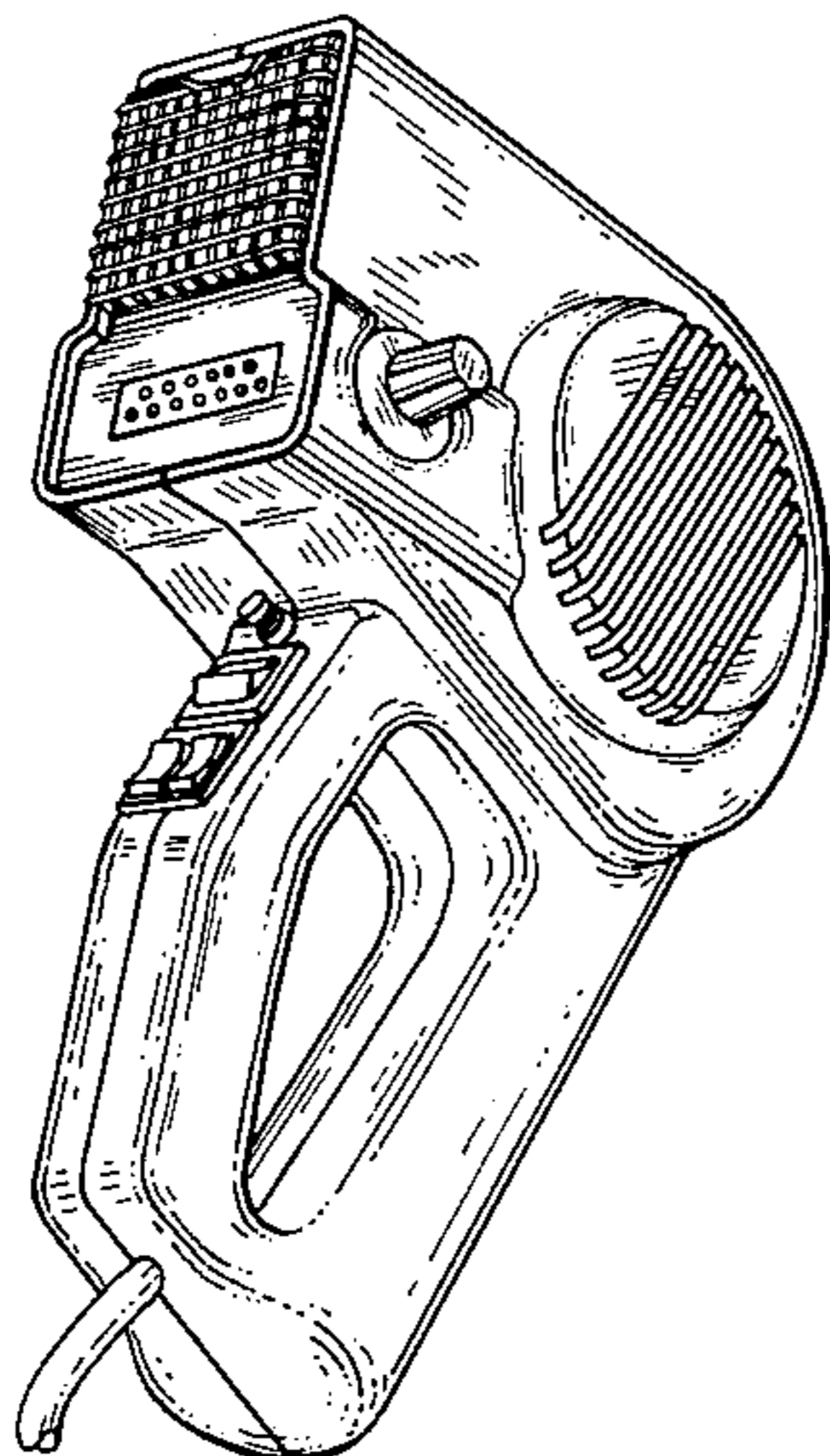

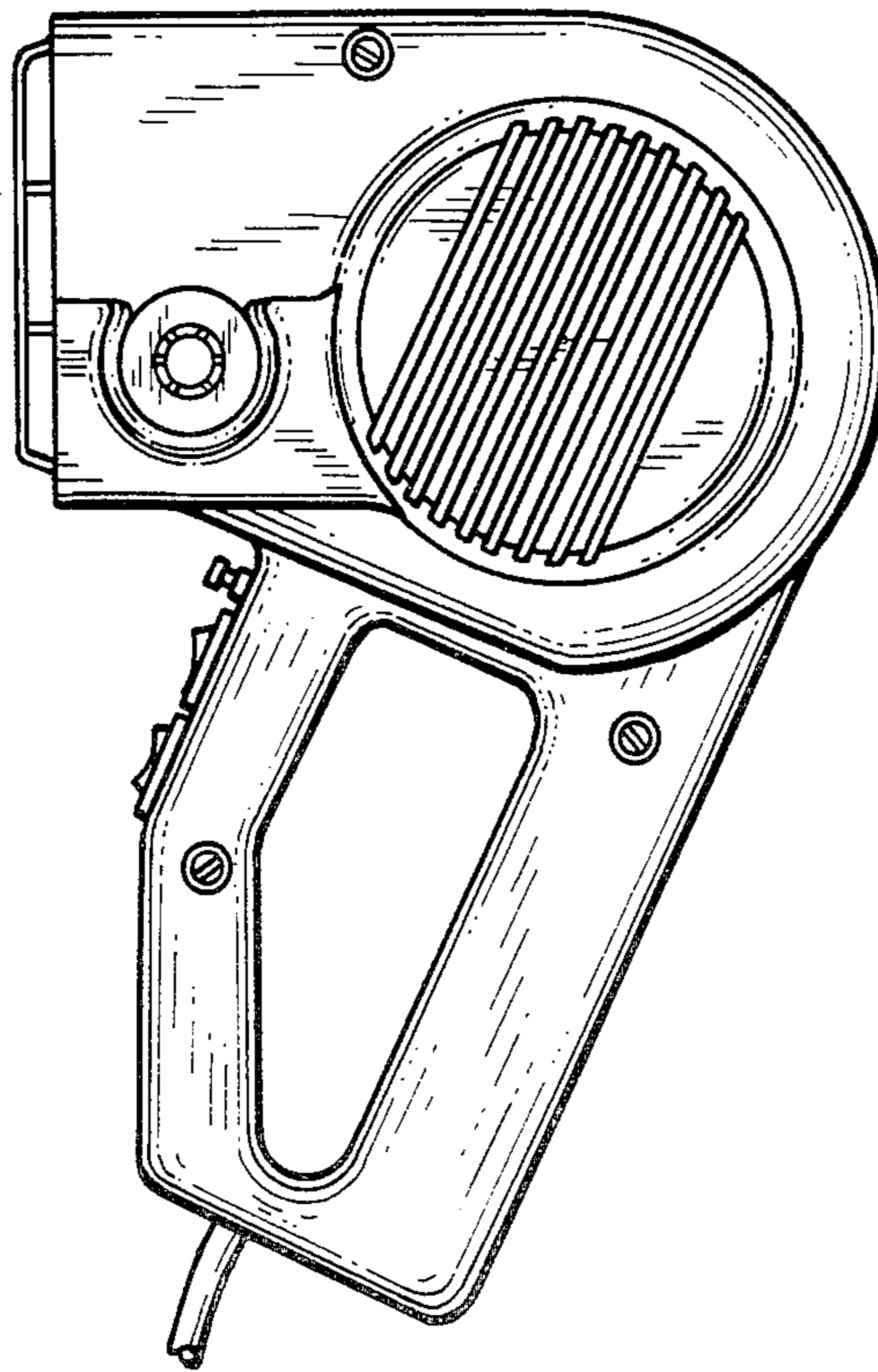

FIG. 1

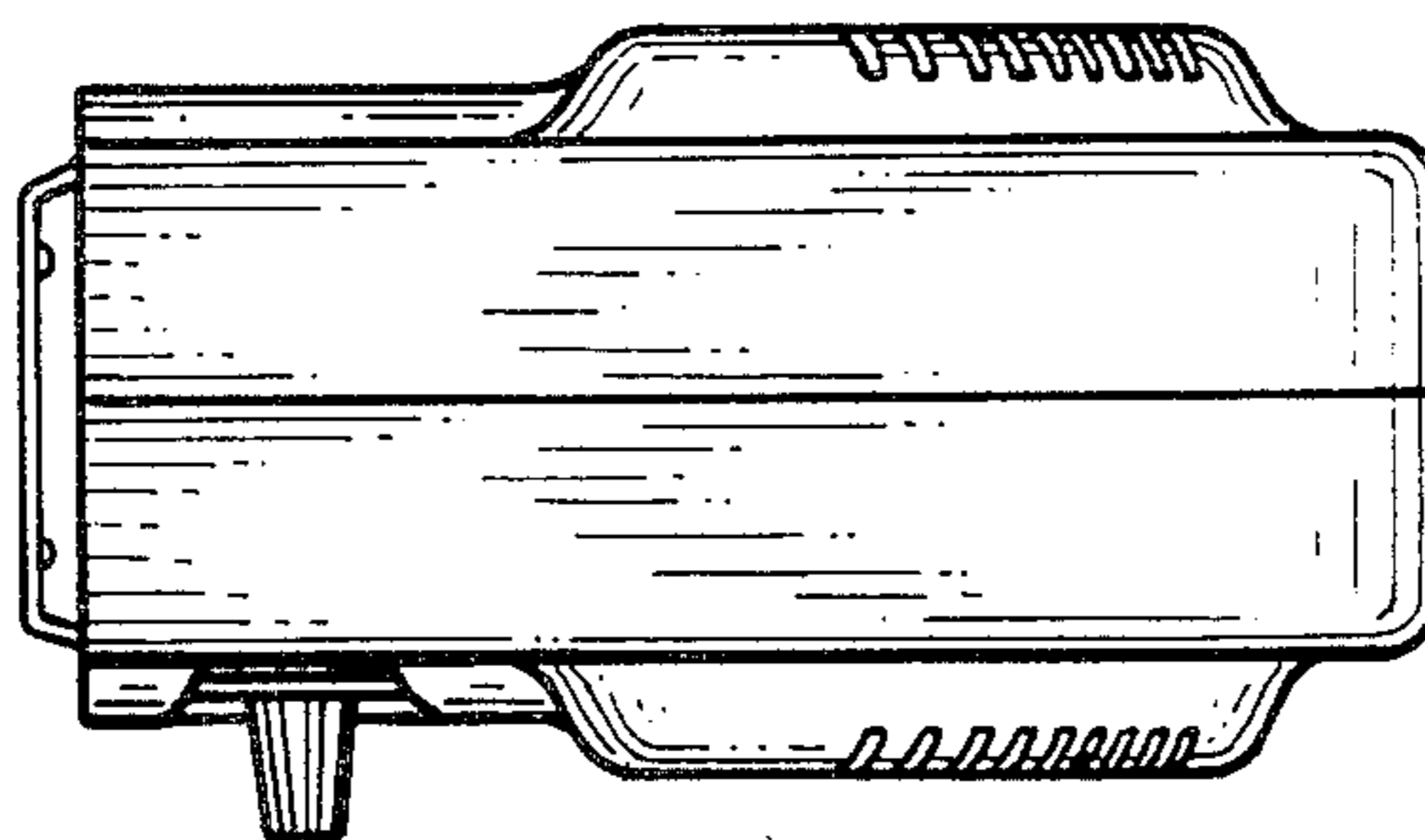

FIG. 2

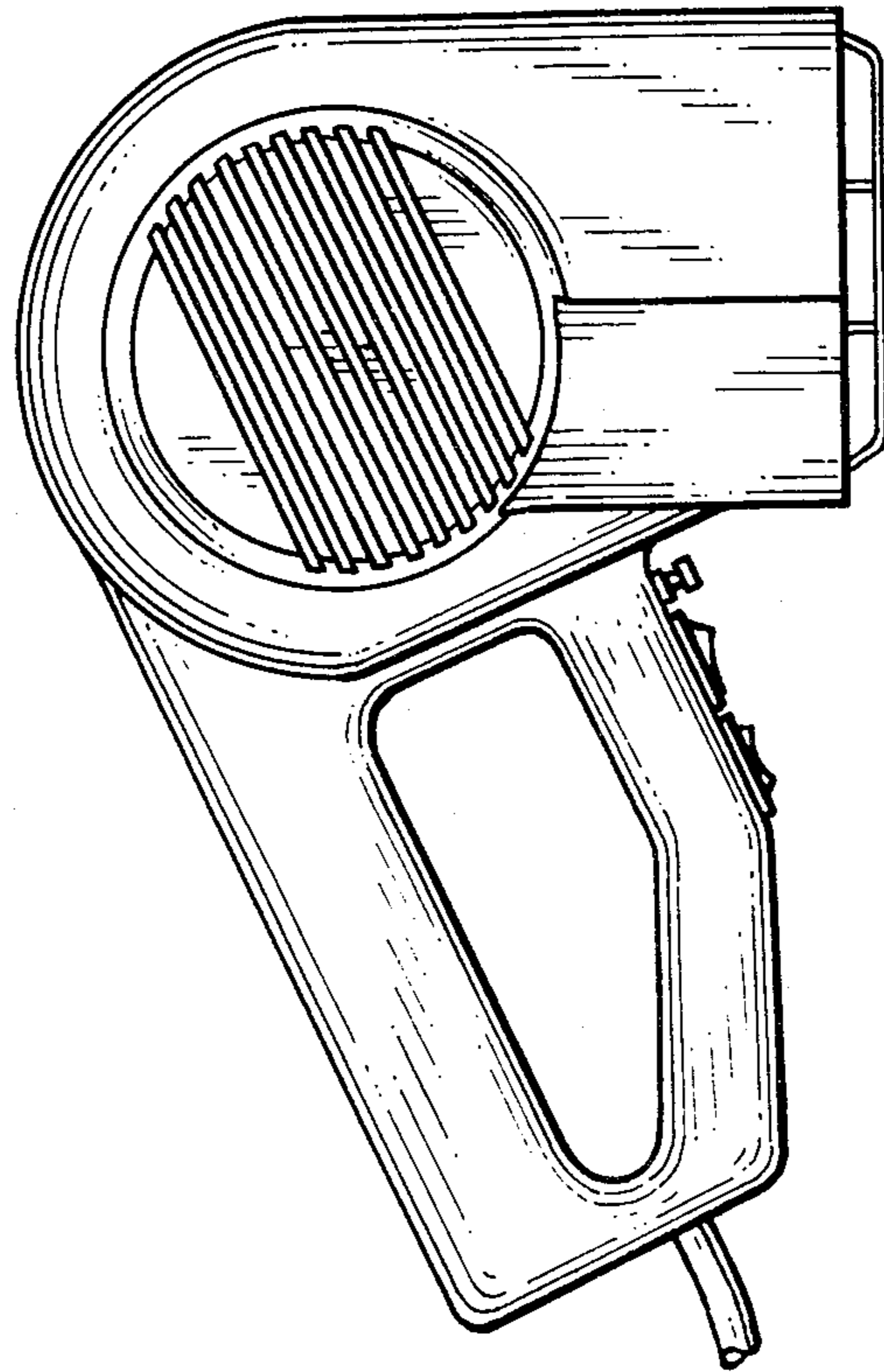

FIG. 3

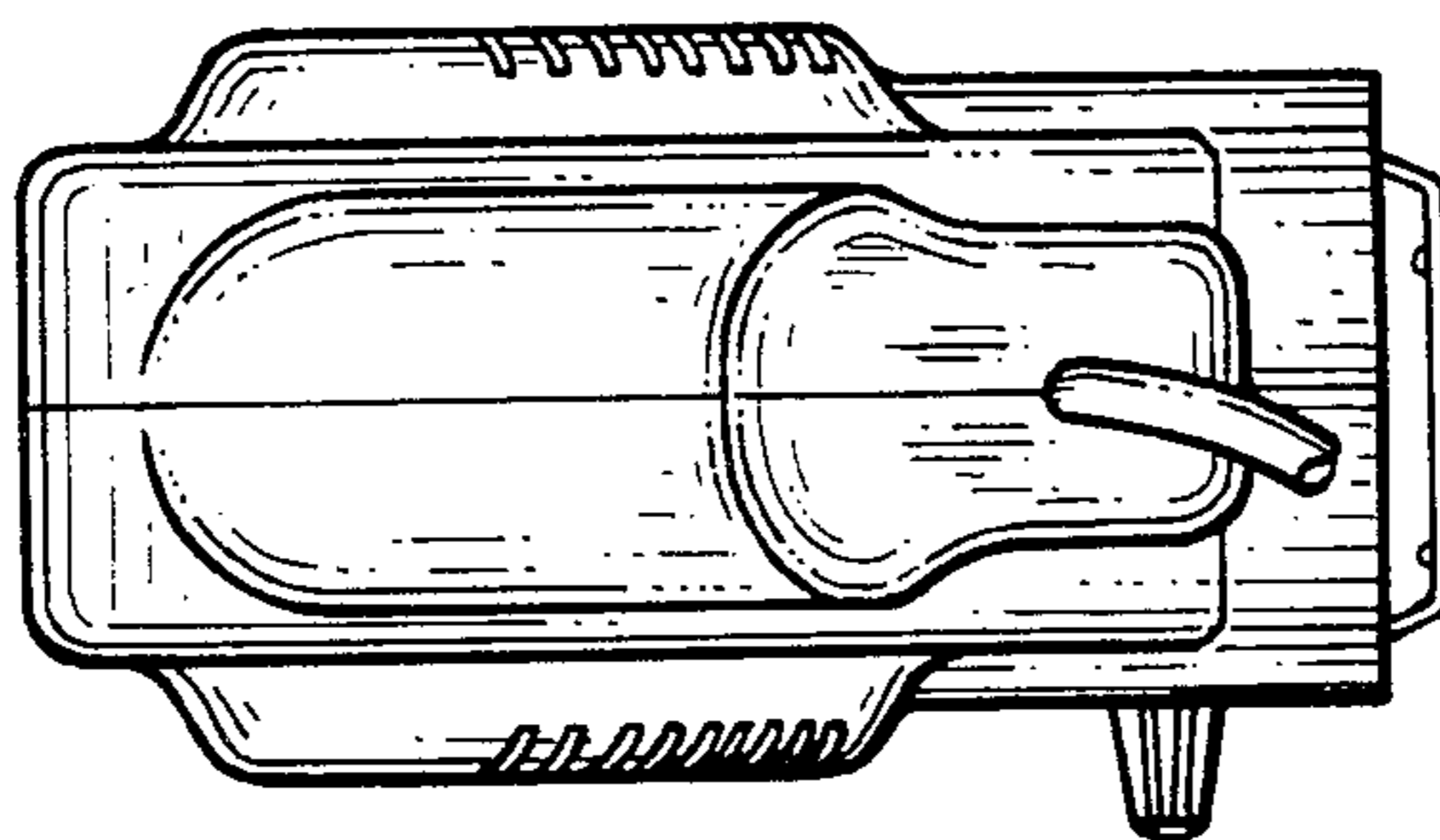

FIG. 4

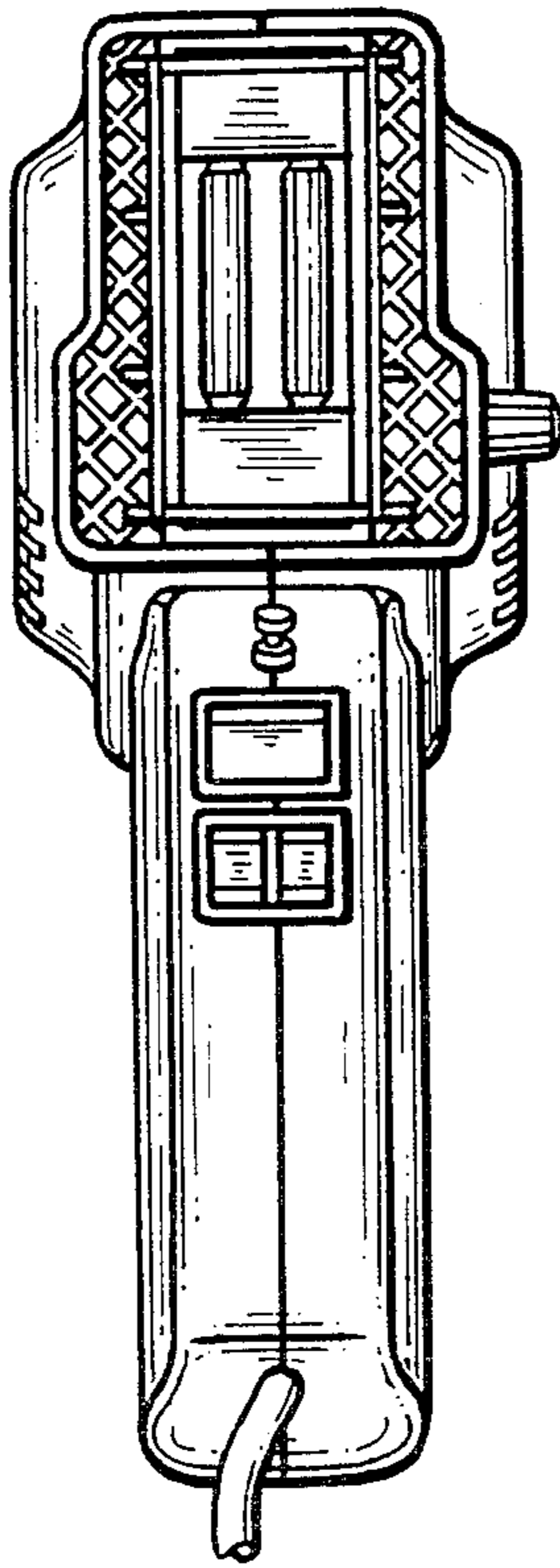

FIG. 5

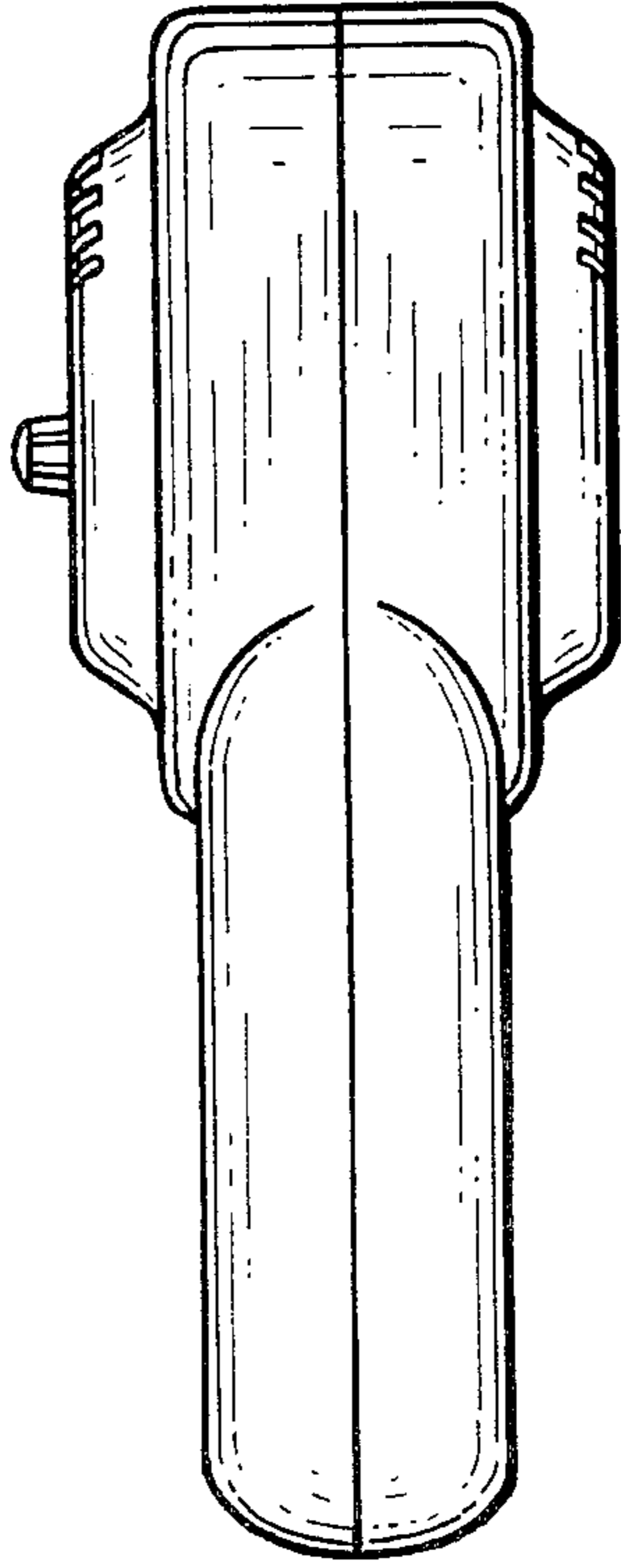
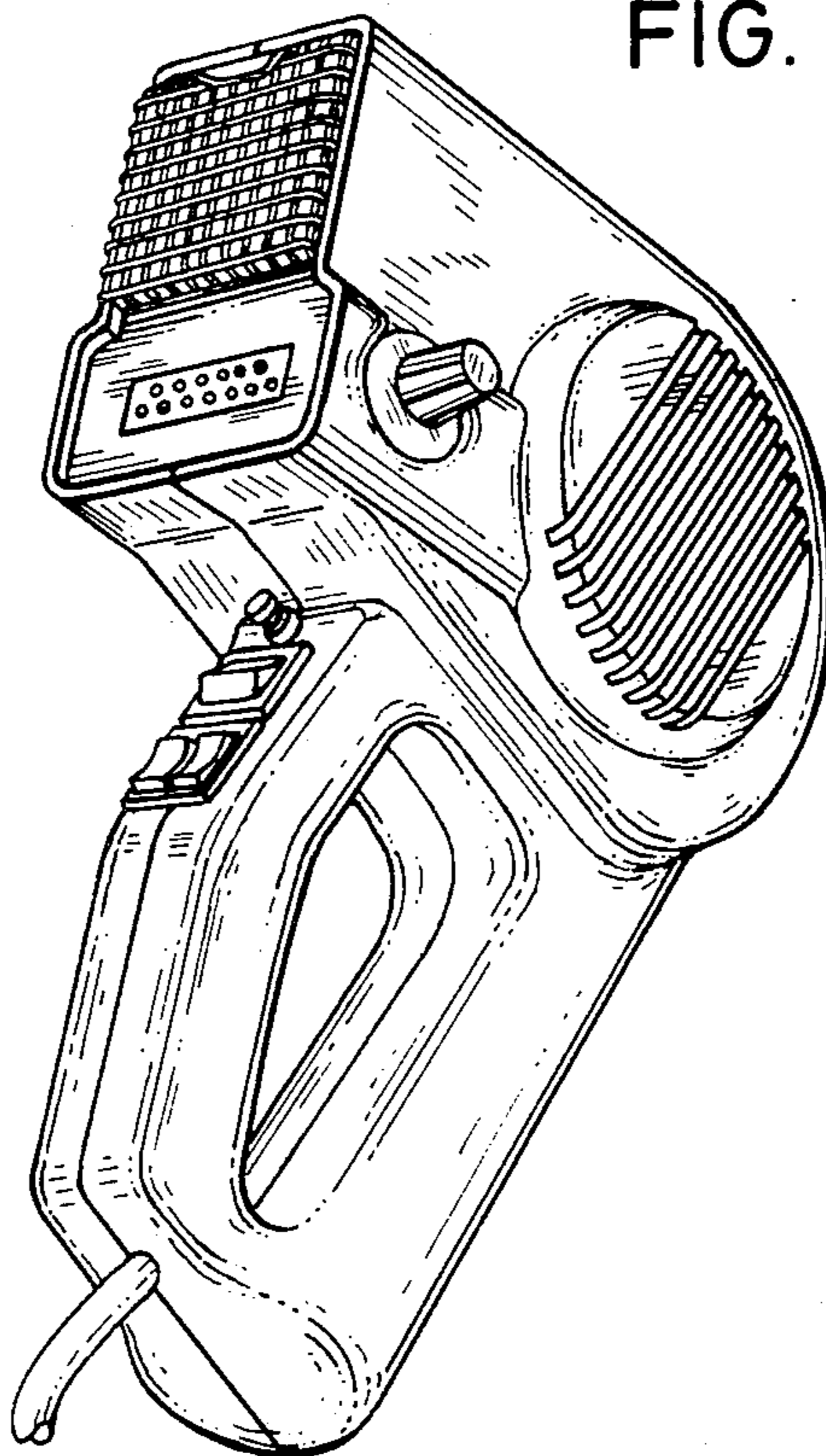

FIG. 6

FIG. 7



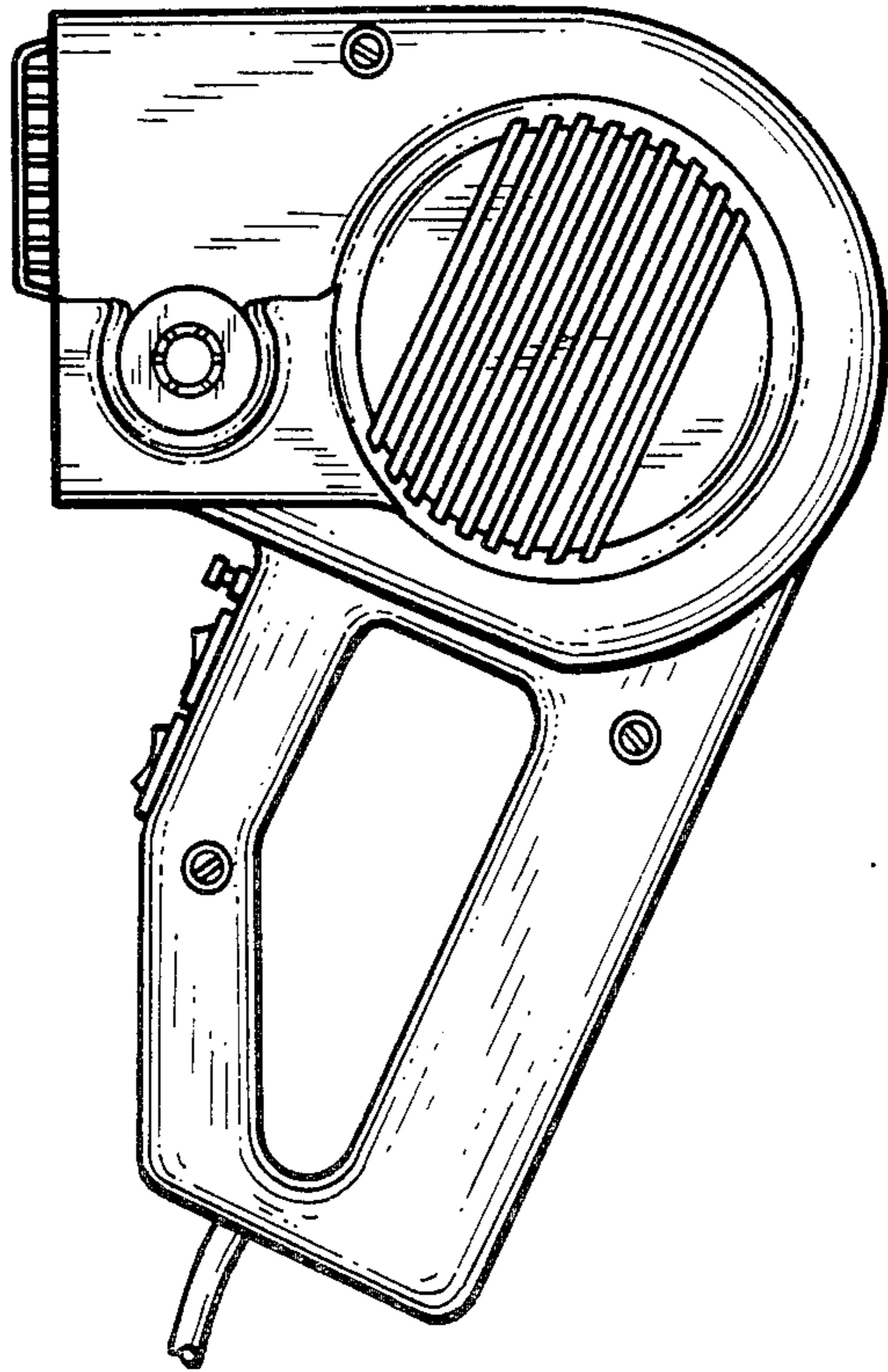

FIG. 8

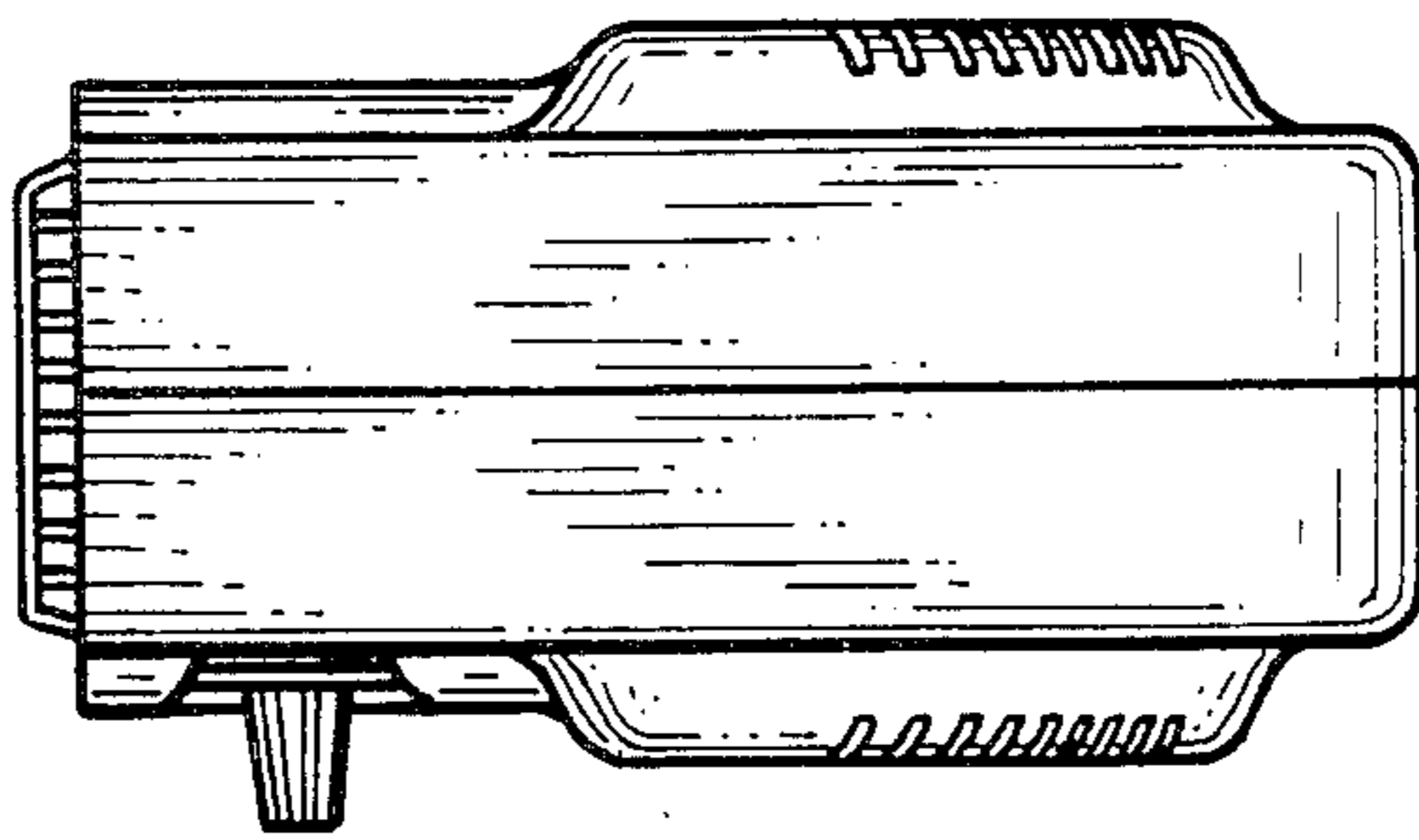

FIG. 9

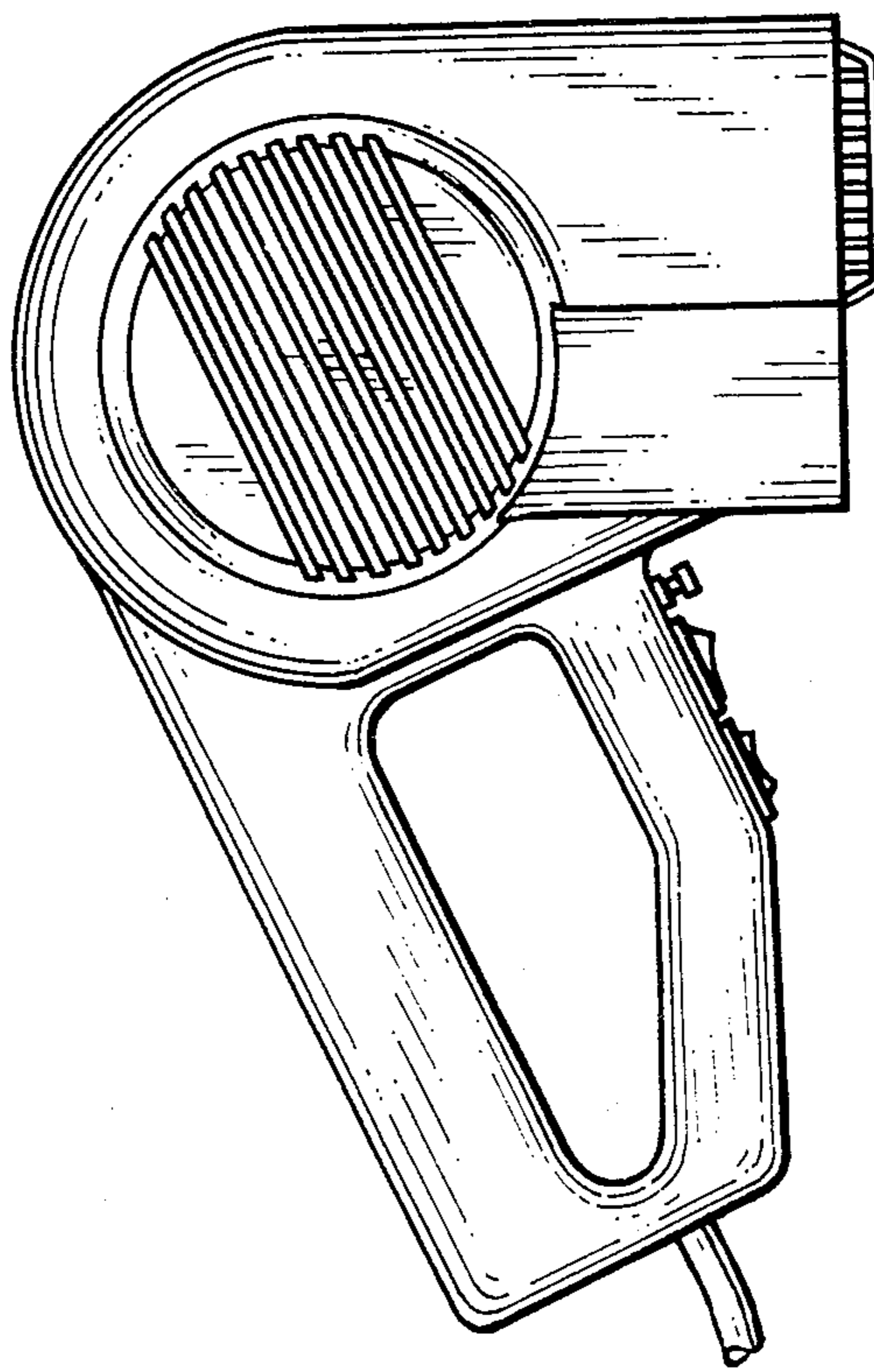

FIG. 10

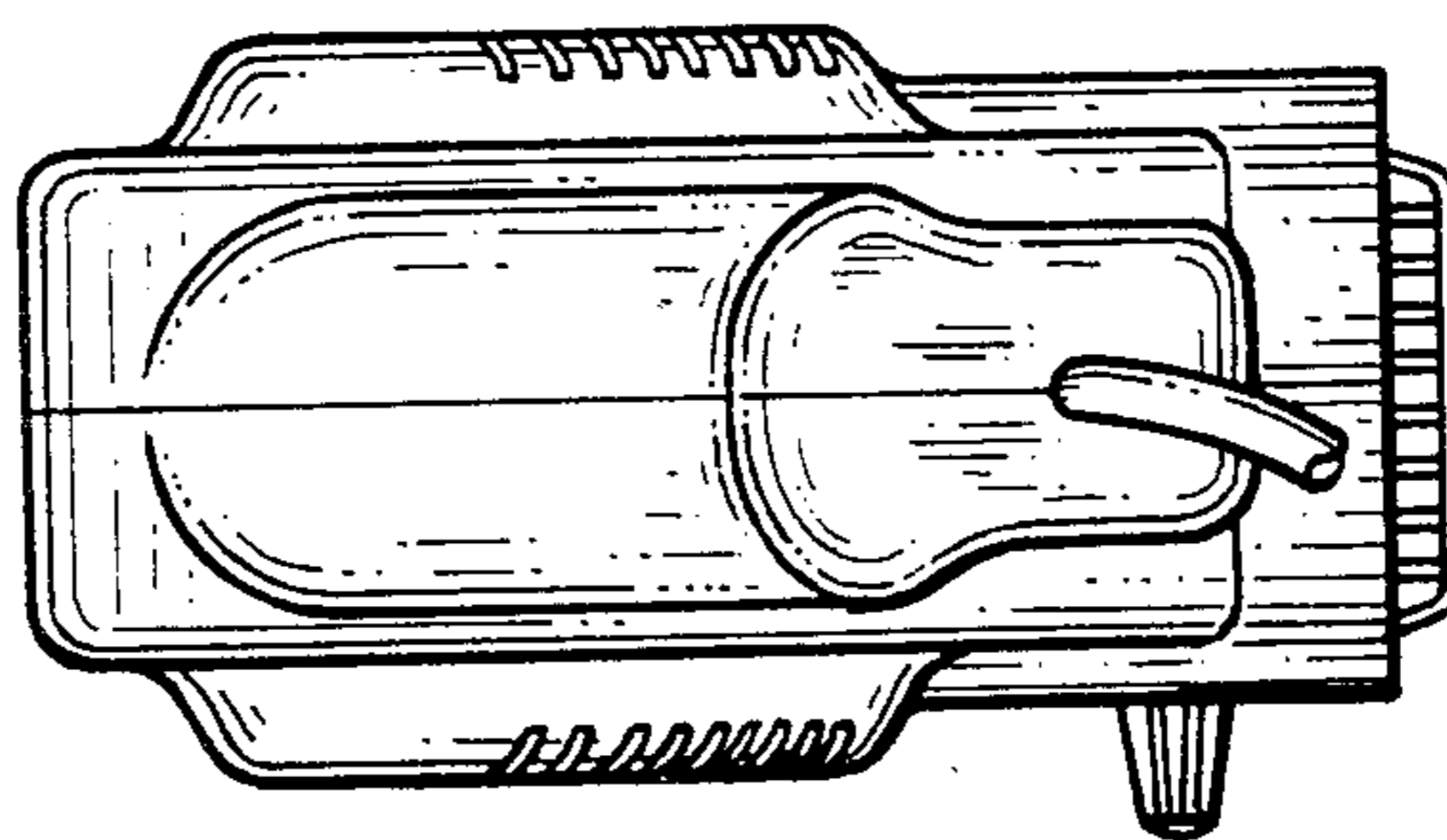

FIG. 11

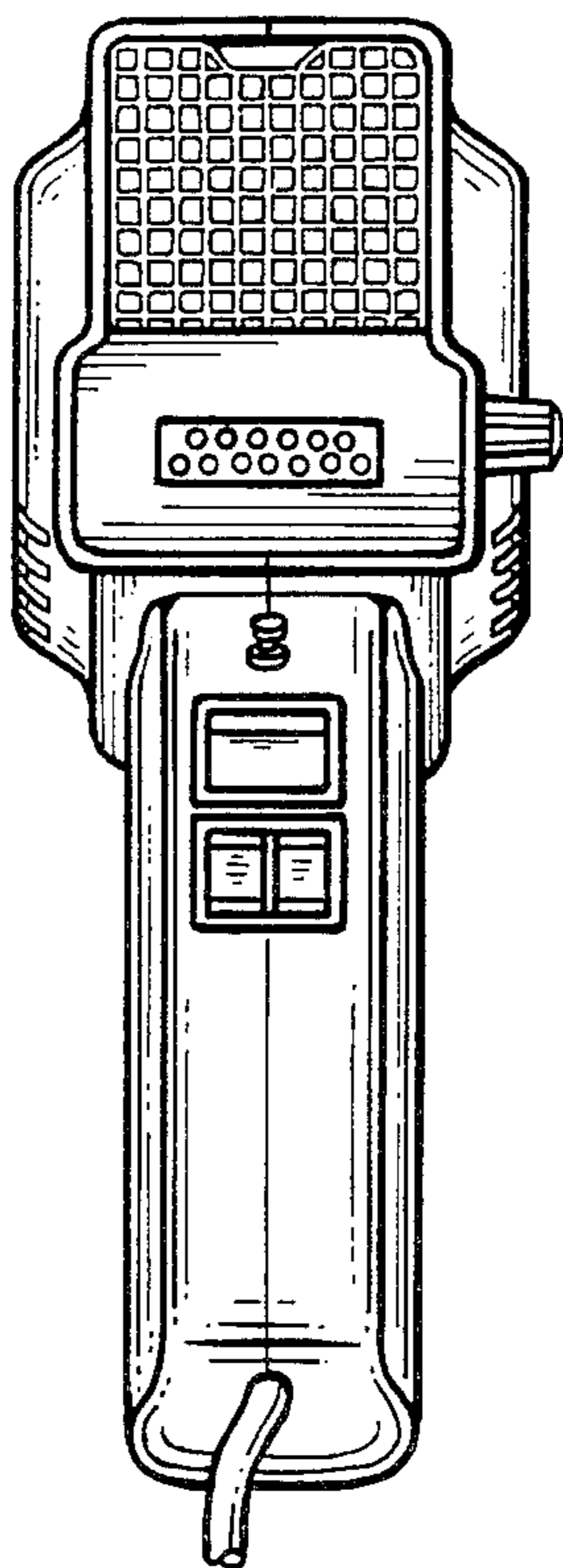

FIG. 12

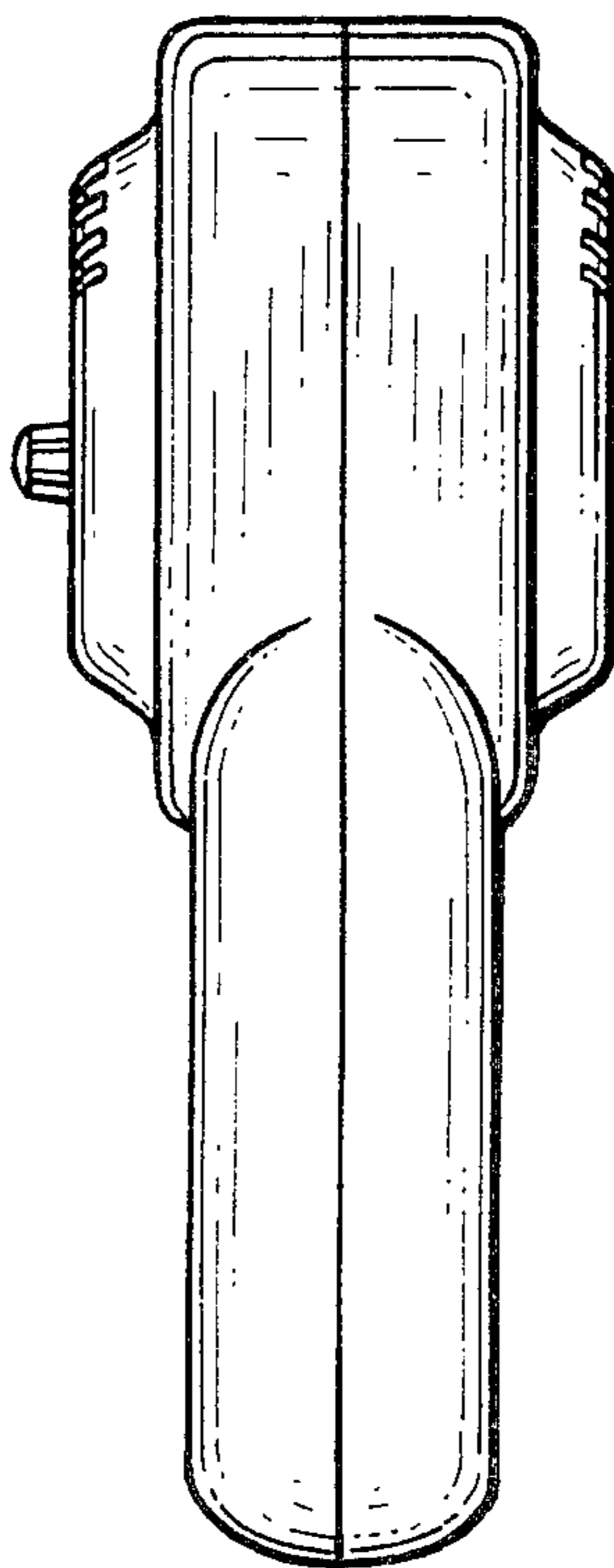
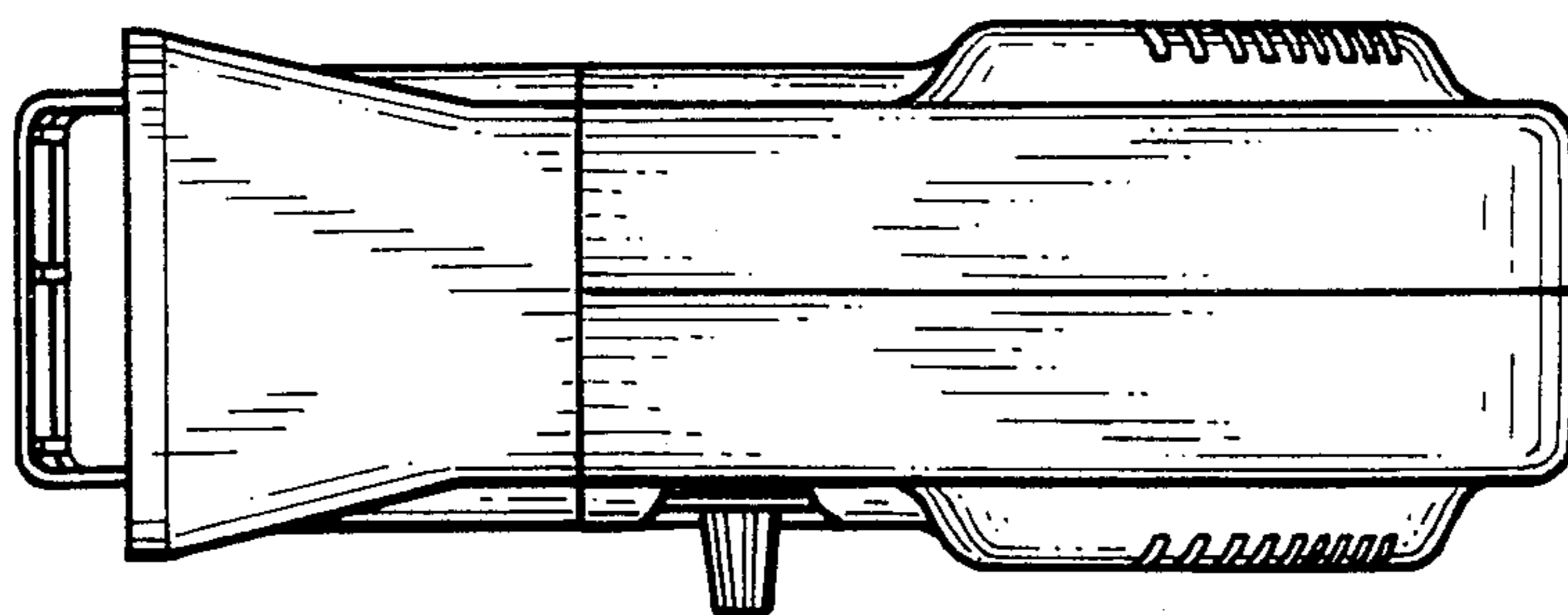
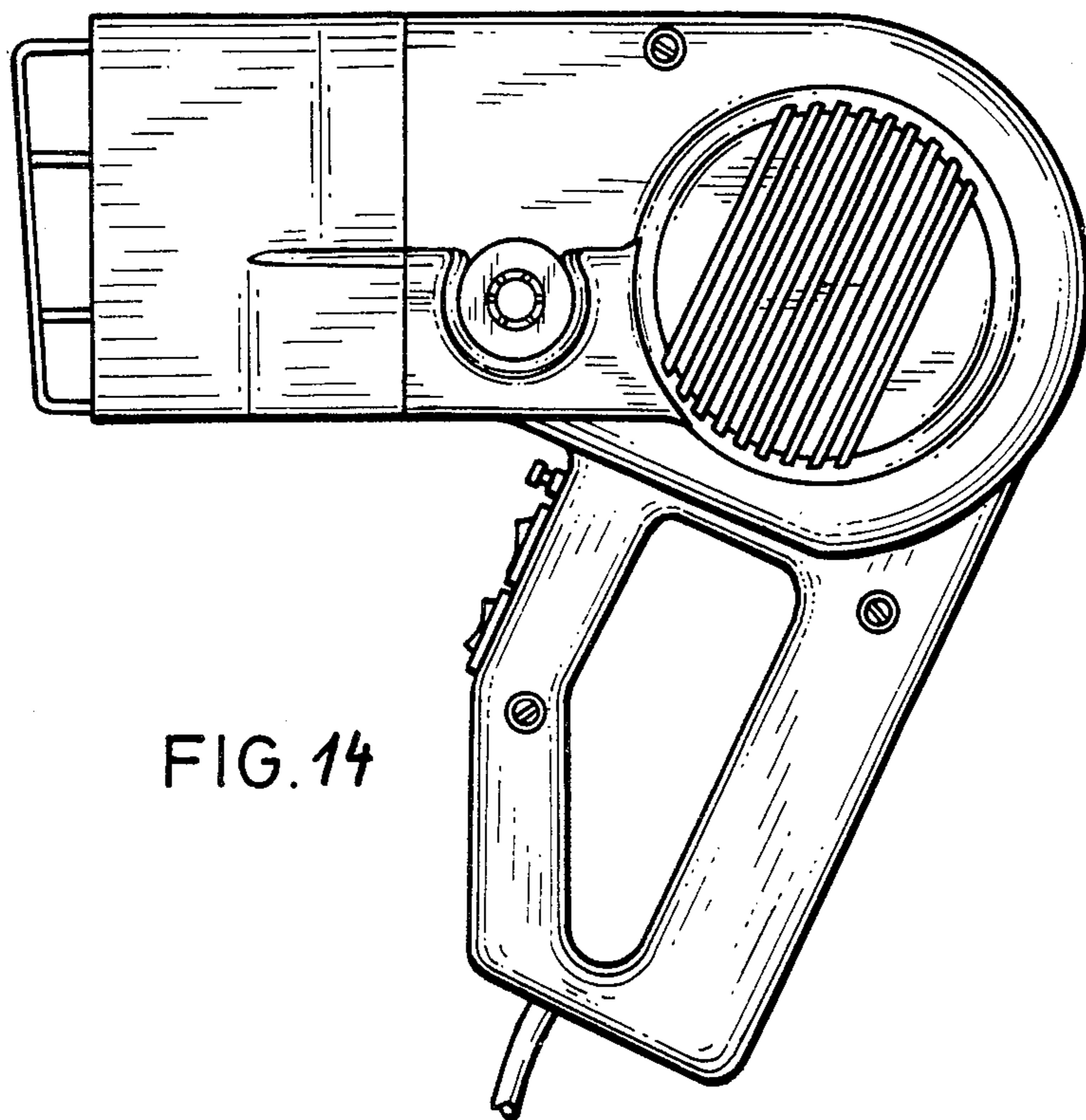

FIG. 13





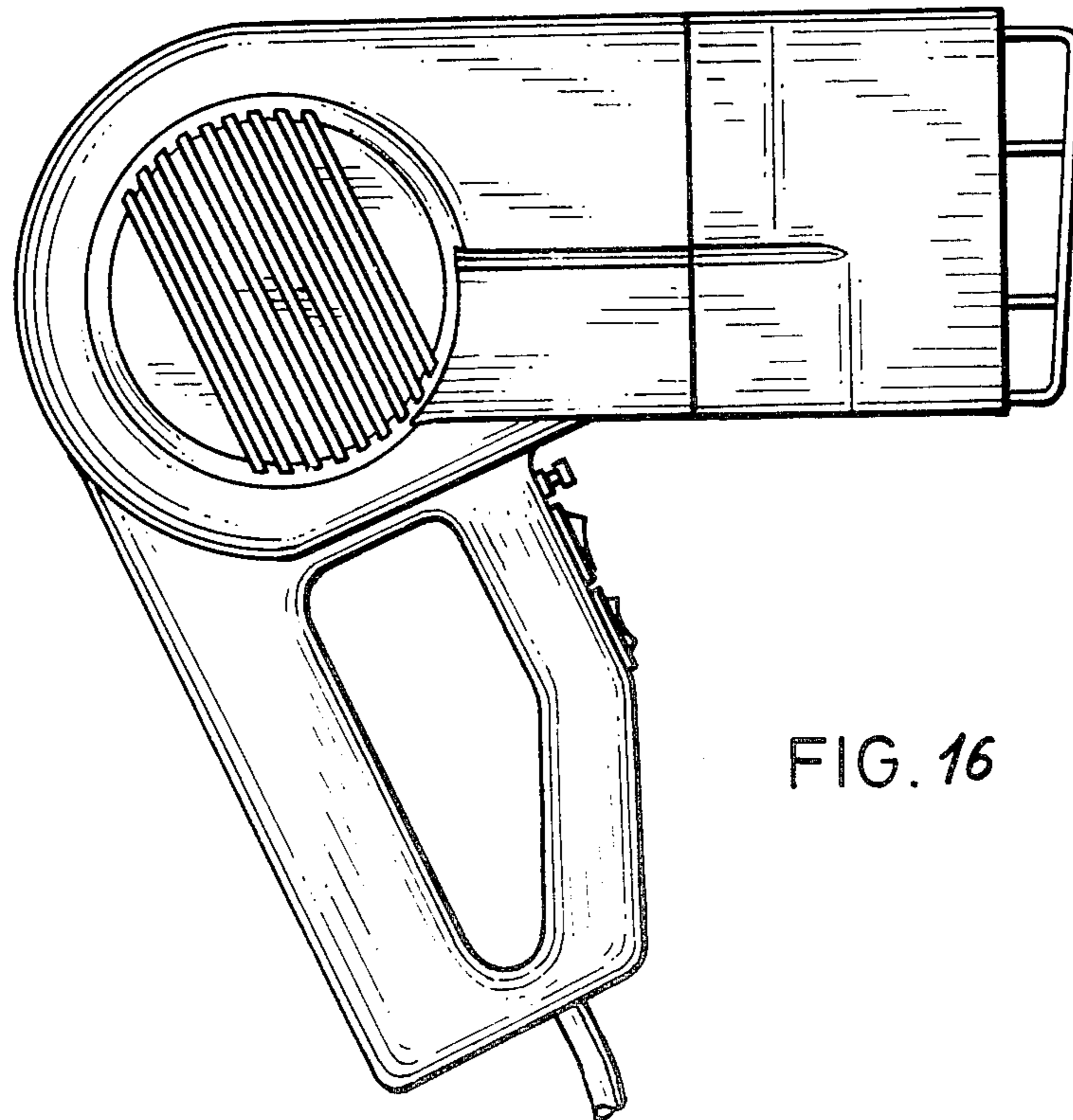

FIG. 16

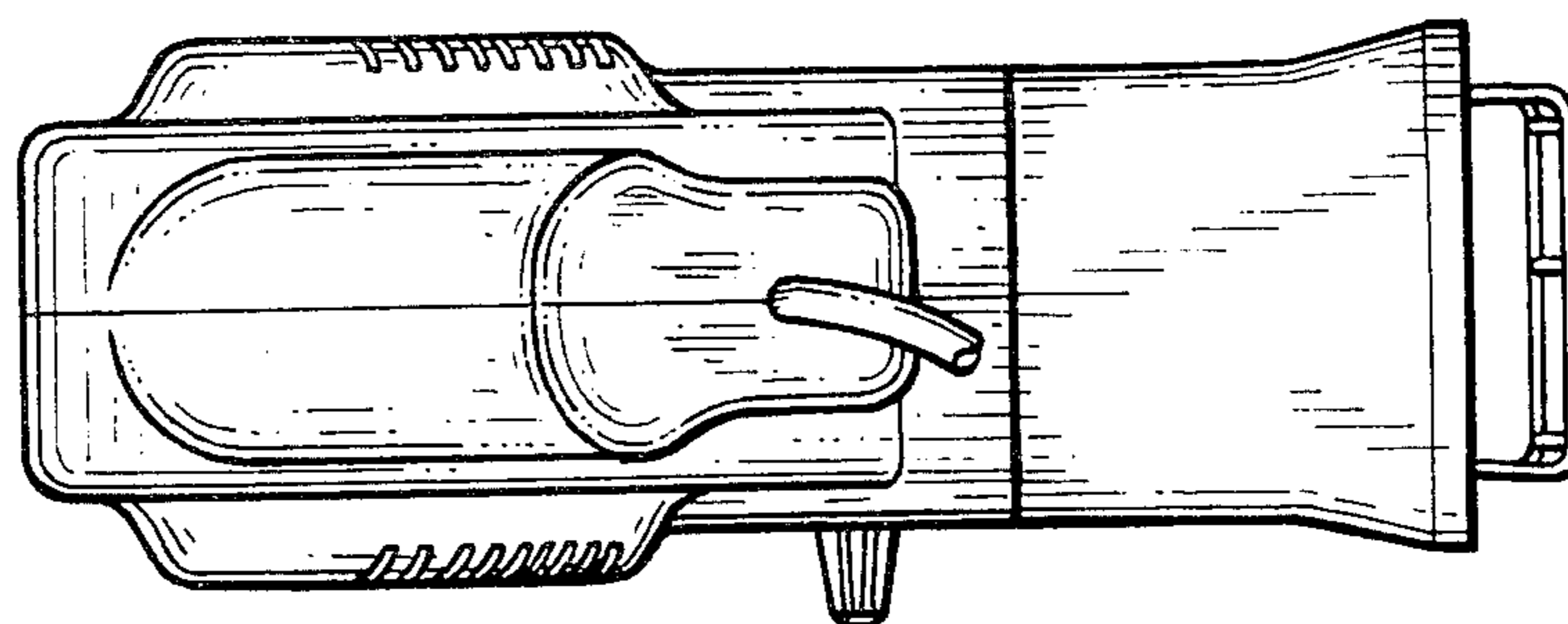

FIG. 17

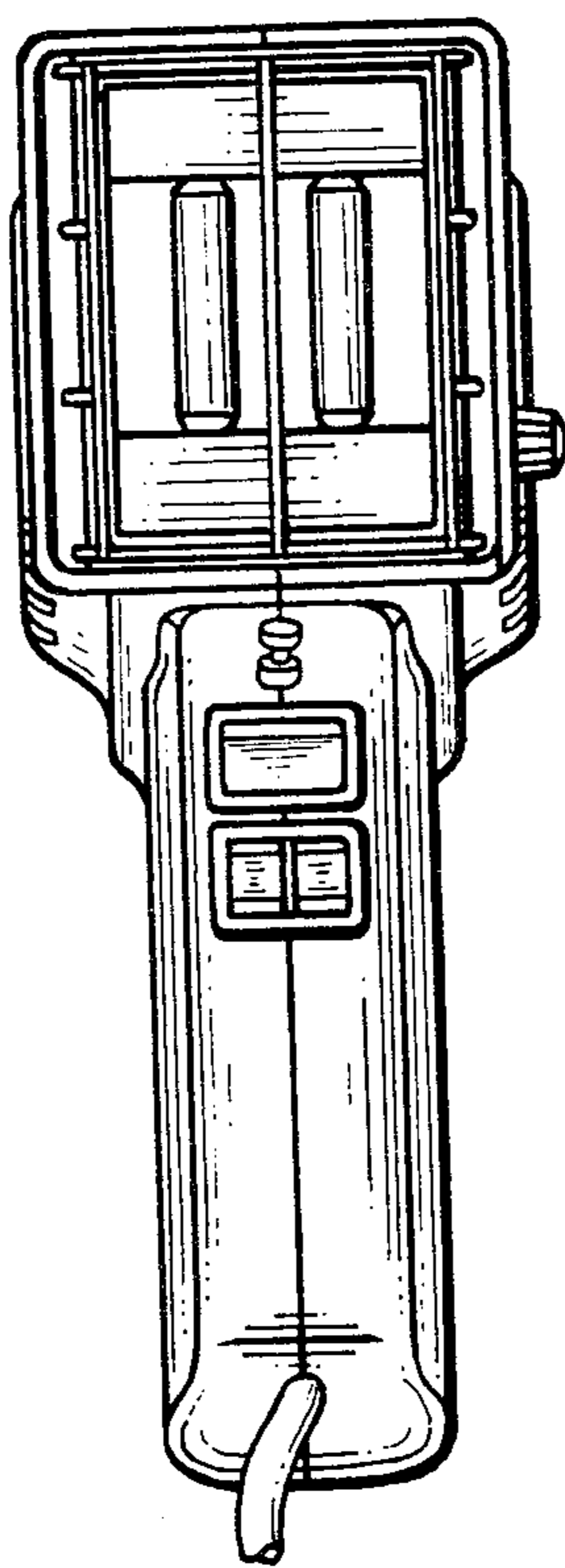

FIG. 18

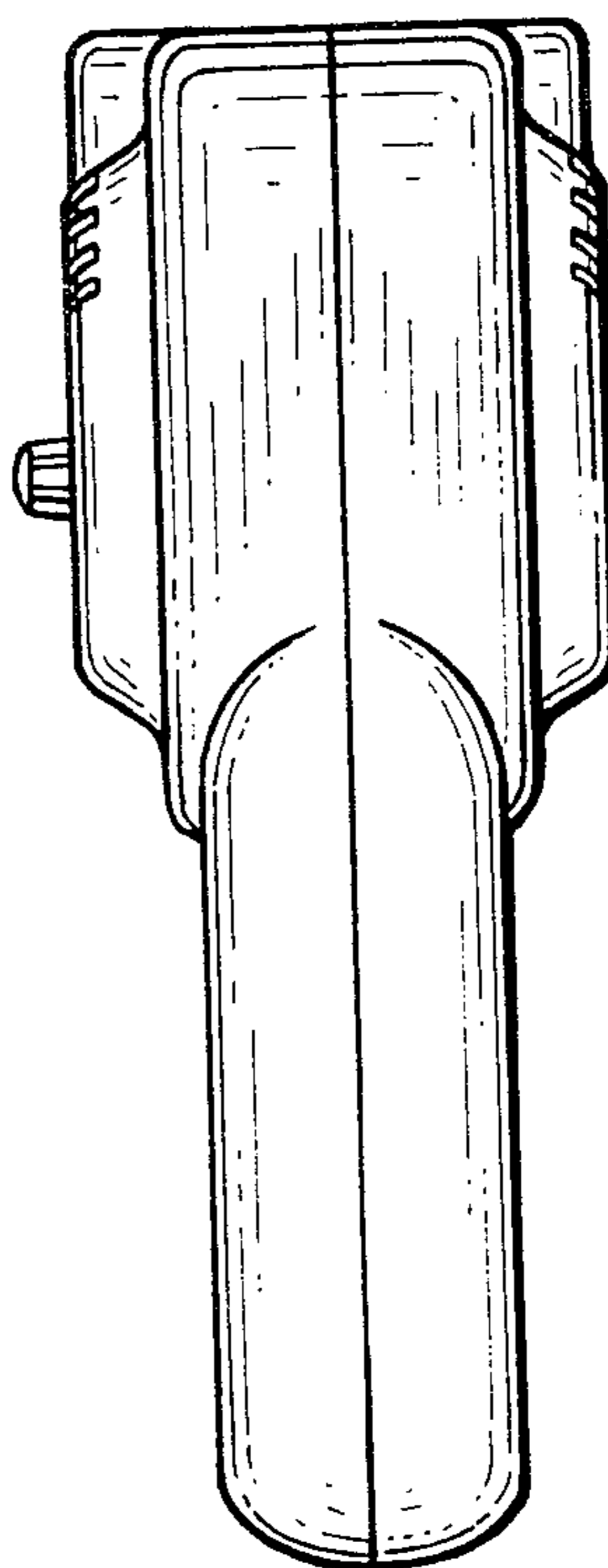

FIG. 19