

[54] CANDLE LAMP

[75] Inventor: William J. Williams, Shelbyville, Ind.

[73] Assignee: Williams Industries, Inc., Shelbyville, Ind.

[\*\*] Term: 14 Years

[21] Appl. No.: 523,386

[22] Filed: Aug. 15, 1983

[52] U.S. Cl. .... D26/11

[58] Field of Search ..... D26/5-23; 431/125, 288-297, 320; 362/161, 162, 163, 392

[56] References Cited

U.S. PATENT DOCUMENTS

4,260,365 4/1981 Kayne ..... 431/291

OTHER PUBLICATIONS

Candlamp Unlimited Flyer, 1965, Candle Lamp #CJ 303.

Continental Candle Co.™ Catalog, ©1977, p. 11, Candle Lamp #144u.

Primary Examiner—Susan J. Lucas

Attorney, Agent, or Firm—Barnes & Thornburg

[57] CLAIM

The ornamental design for a candle lamp, as shown and described.

DESCRIPTION

FIG. 1 is a perspective view of a candle lamp showing my new design;

FIG. 2 is a side elevational view thereof, all sides being identical;

FIGS. 3 and 4 are respectively top and bottom plan views thereof;

FIGS. 5, 6, and 7 are respectively side, top, and bottom views of the base, the interior candle support and the shade being omitted for purposes of disclosure;

FIGS. 8, 9, and 10 are respectively side, top, and bottom views of the interior candle support, the base and the shade being omitted for purposes of disclosure;

FIGS. 11, 12, and 13 are respectively side, top, and bottom views of the shade, the base and interior candle support being omitted for purposes of disclosure;

FIG. 14 is a side elevational view of a shade of a second embodiment of my new design, it being understood that the second embodiment is identical to the first except that the shade of the second is opaque whereas the shade of the first is translucent.

The stippling on the shade in FIGS. 1, 2, 3, 11, 12, and 13 indicates frosted translucent material.

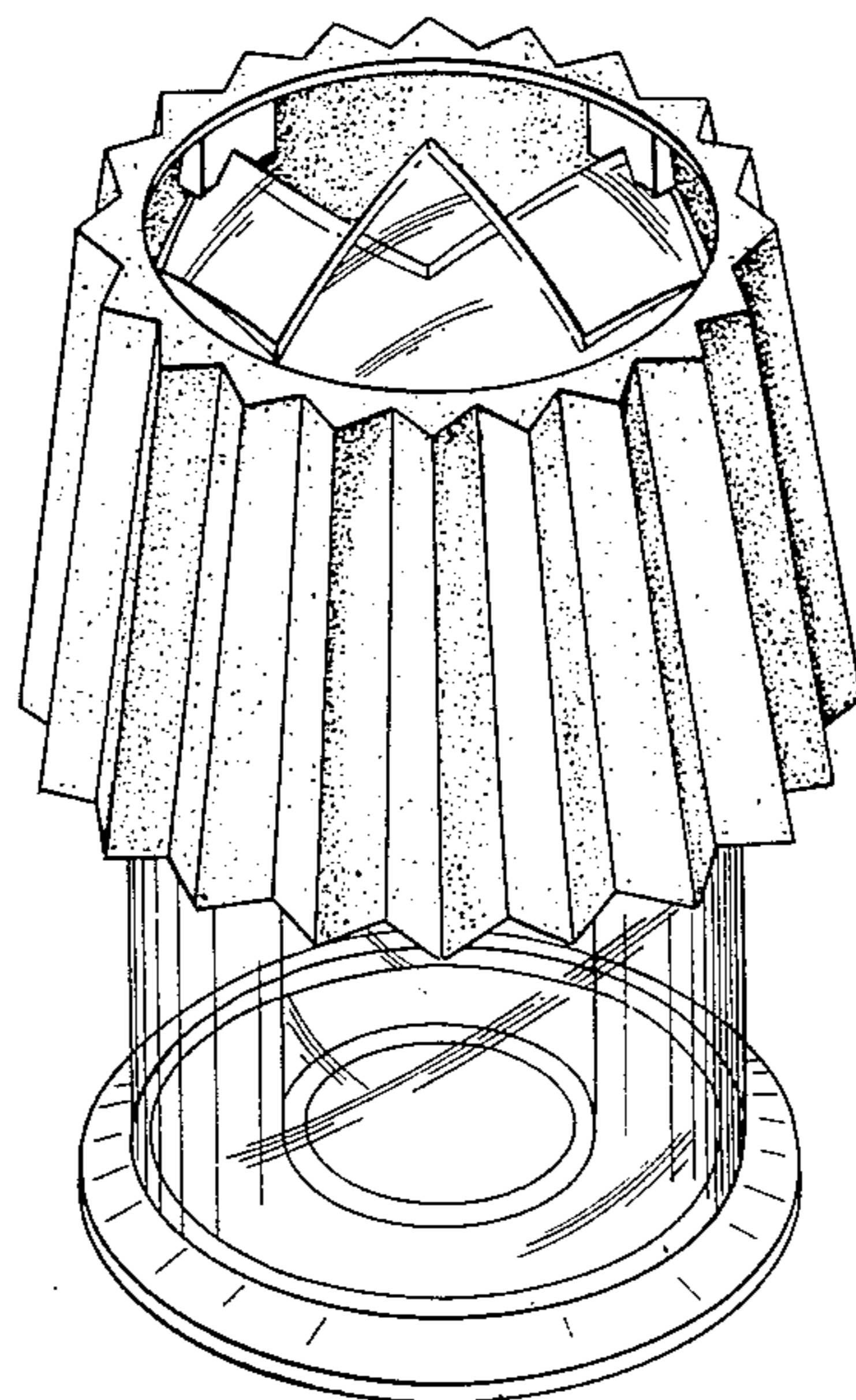

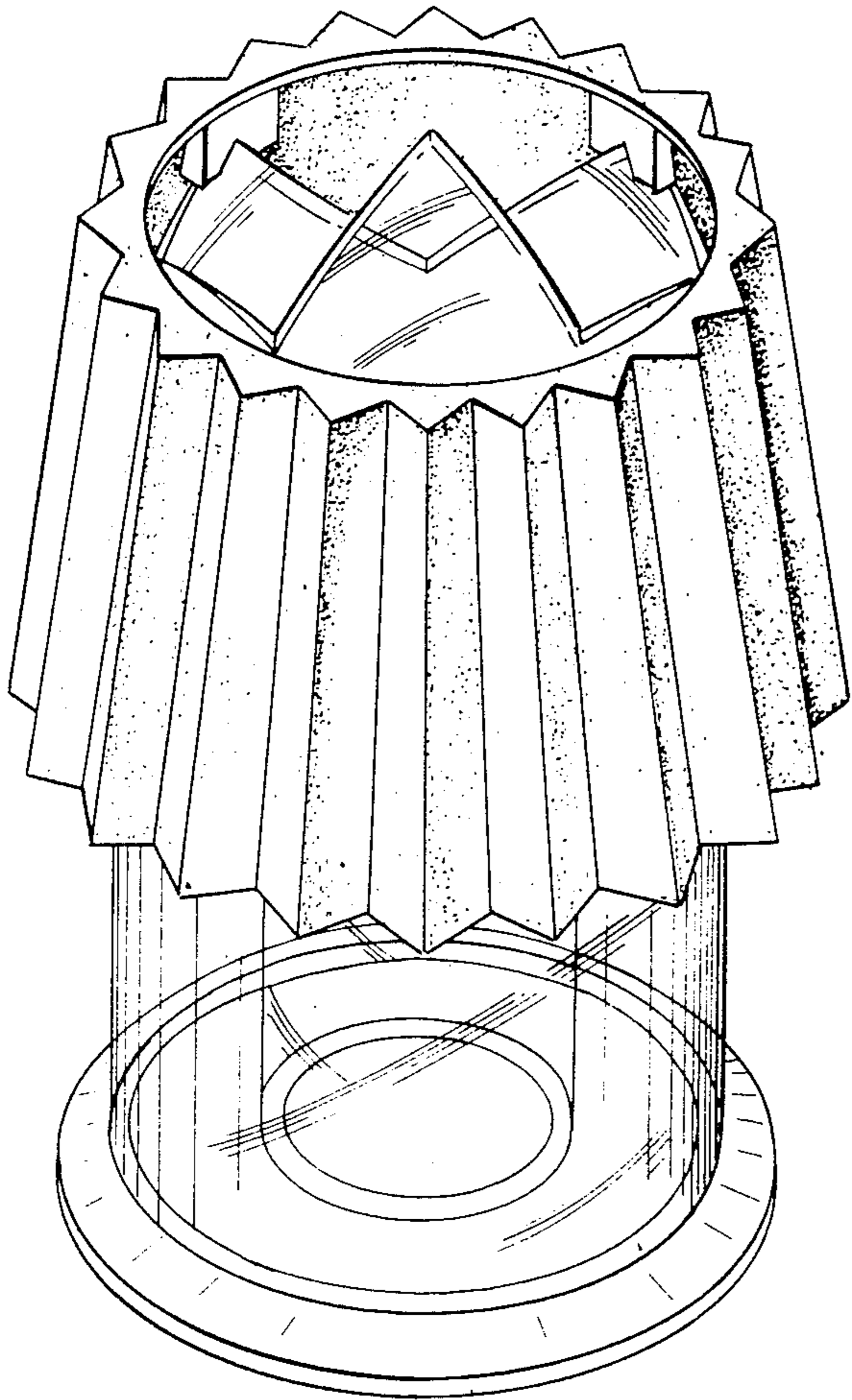

FIG 1

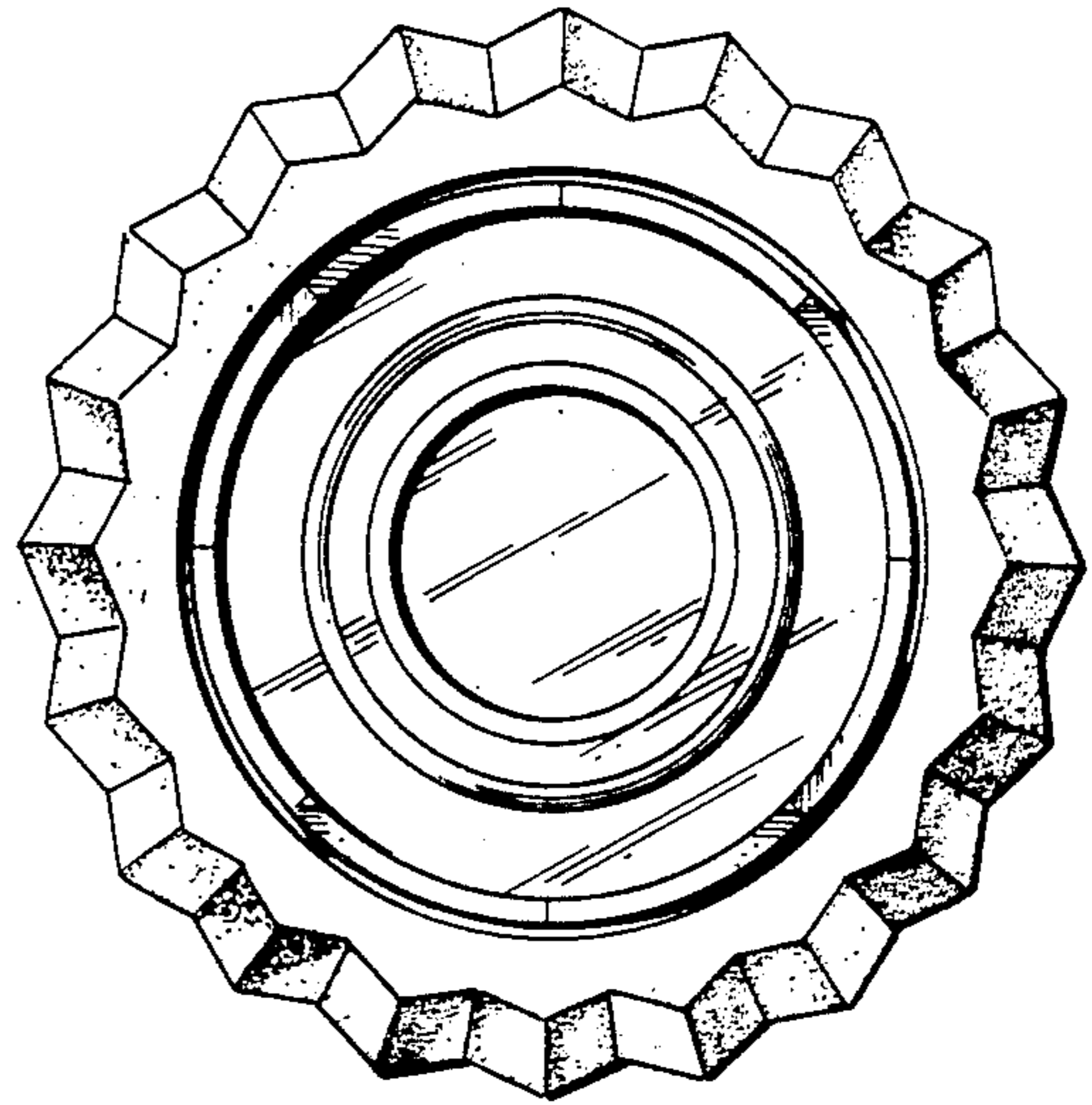

FIG 3

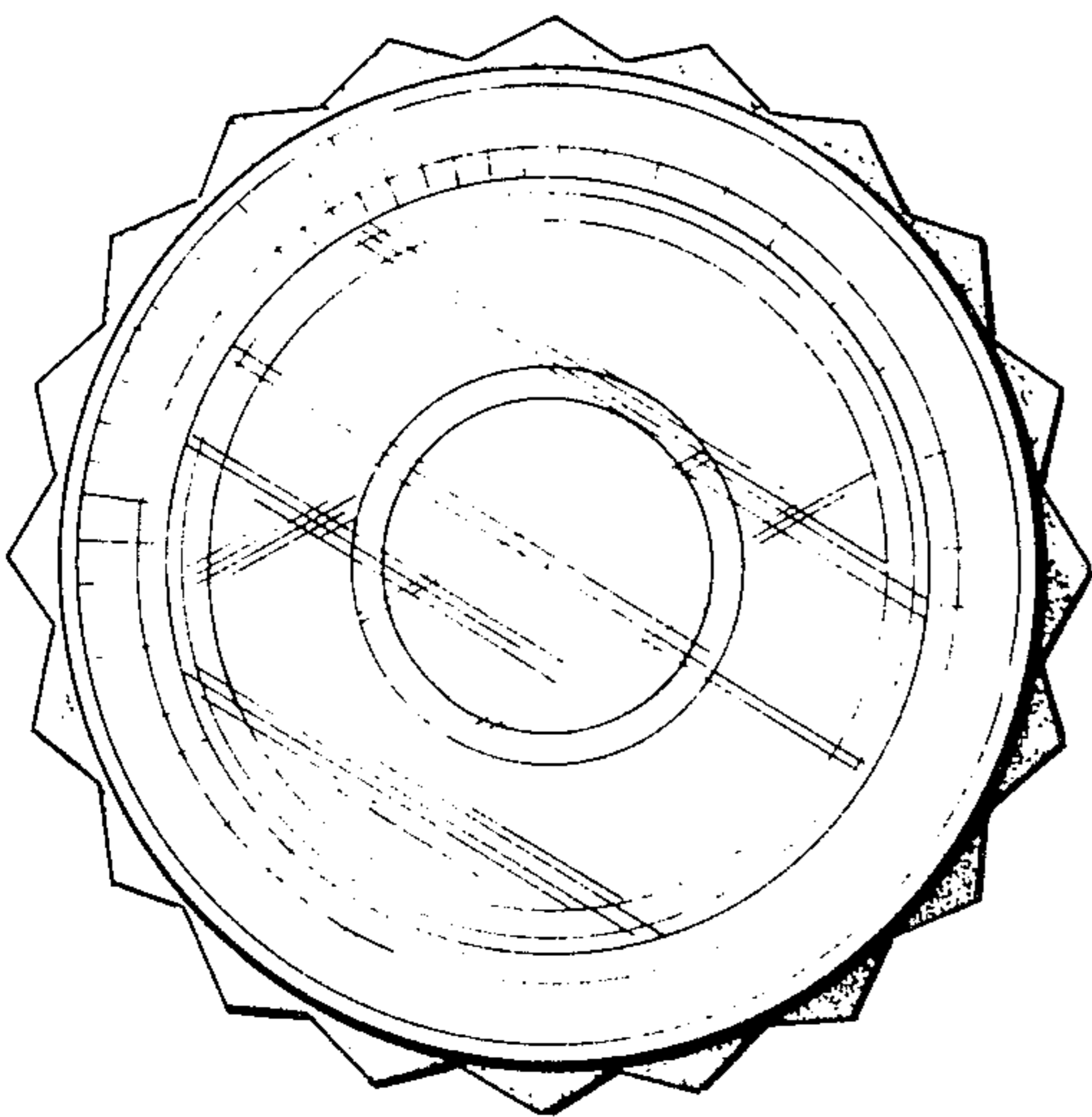

FIG 4

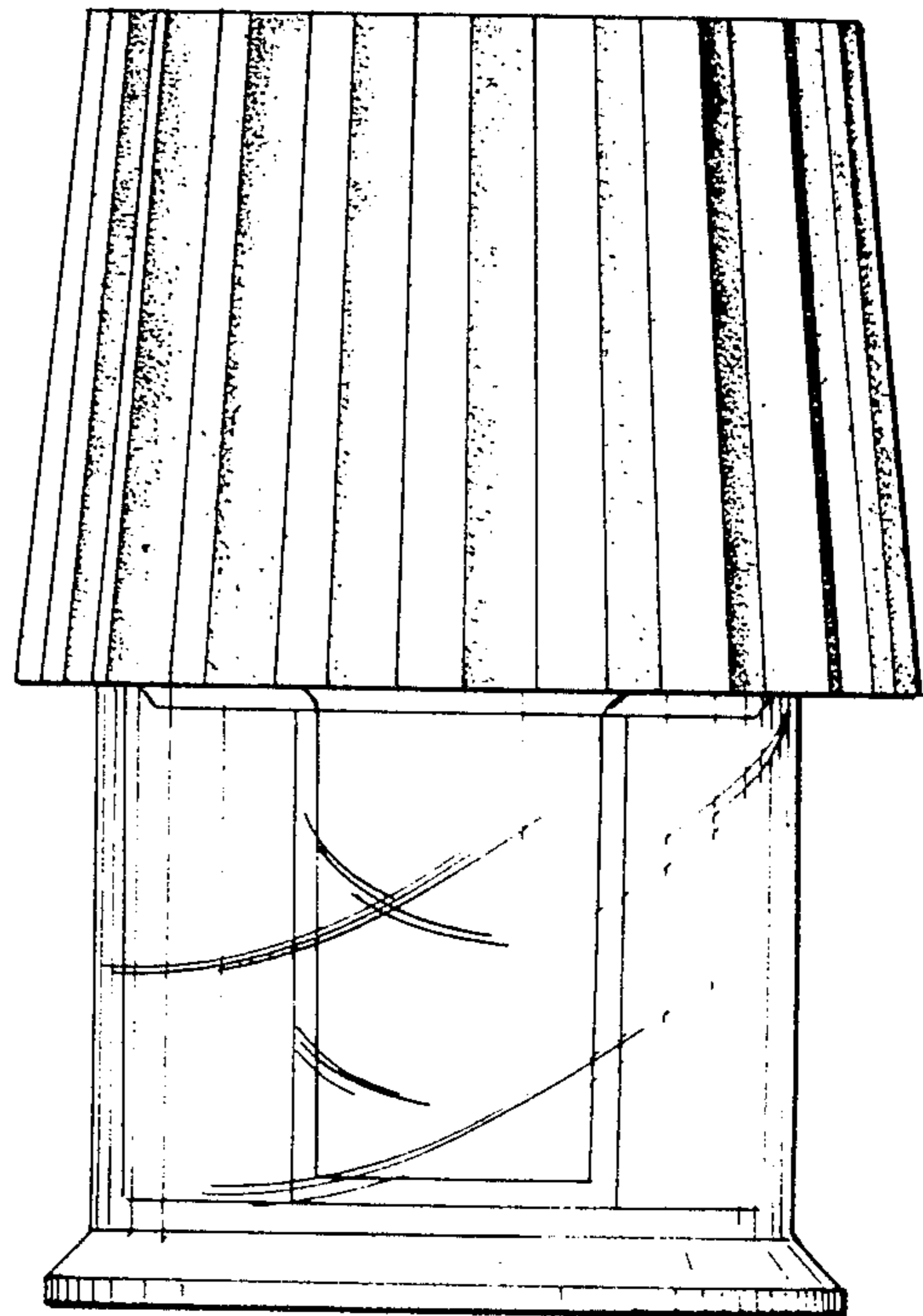
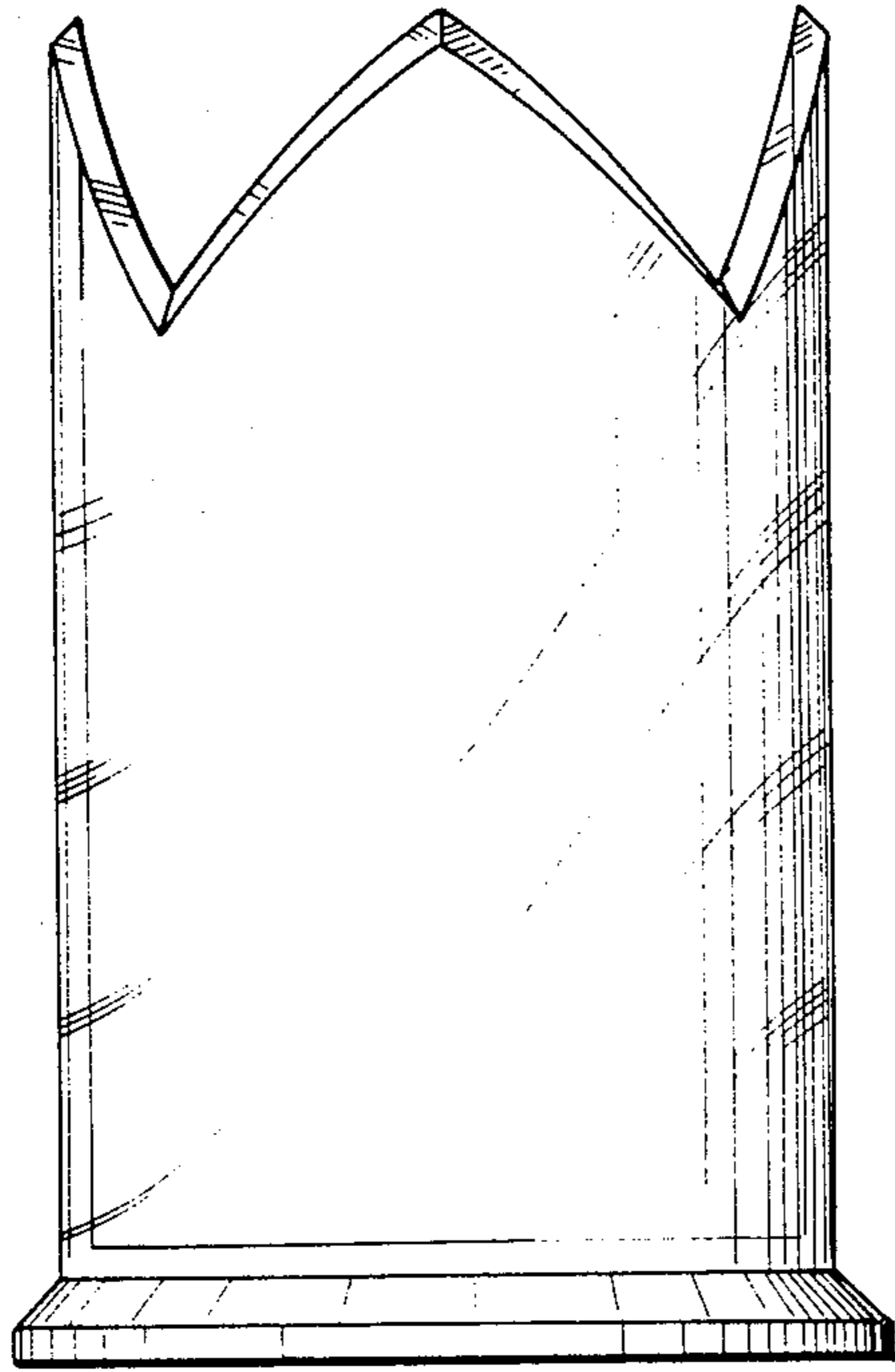
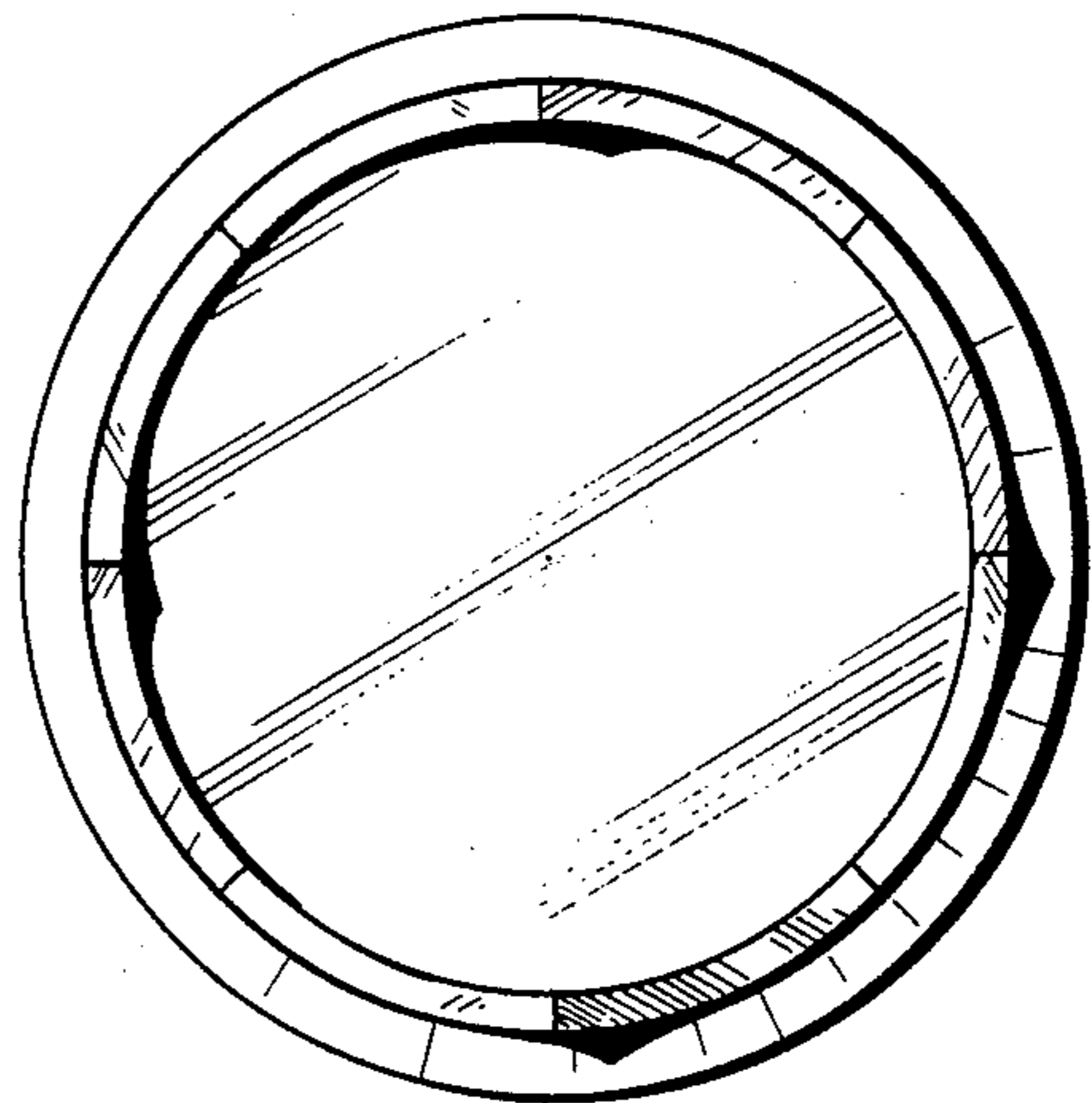

FIG 2



*FIG. 5*



*FIG. 6*

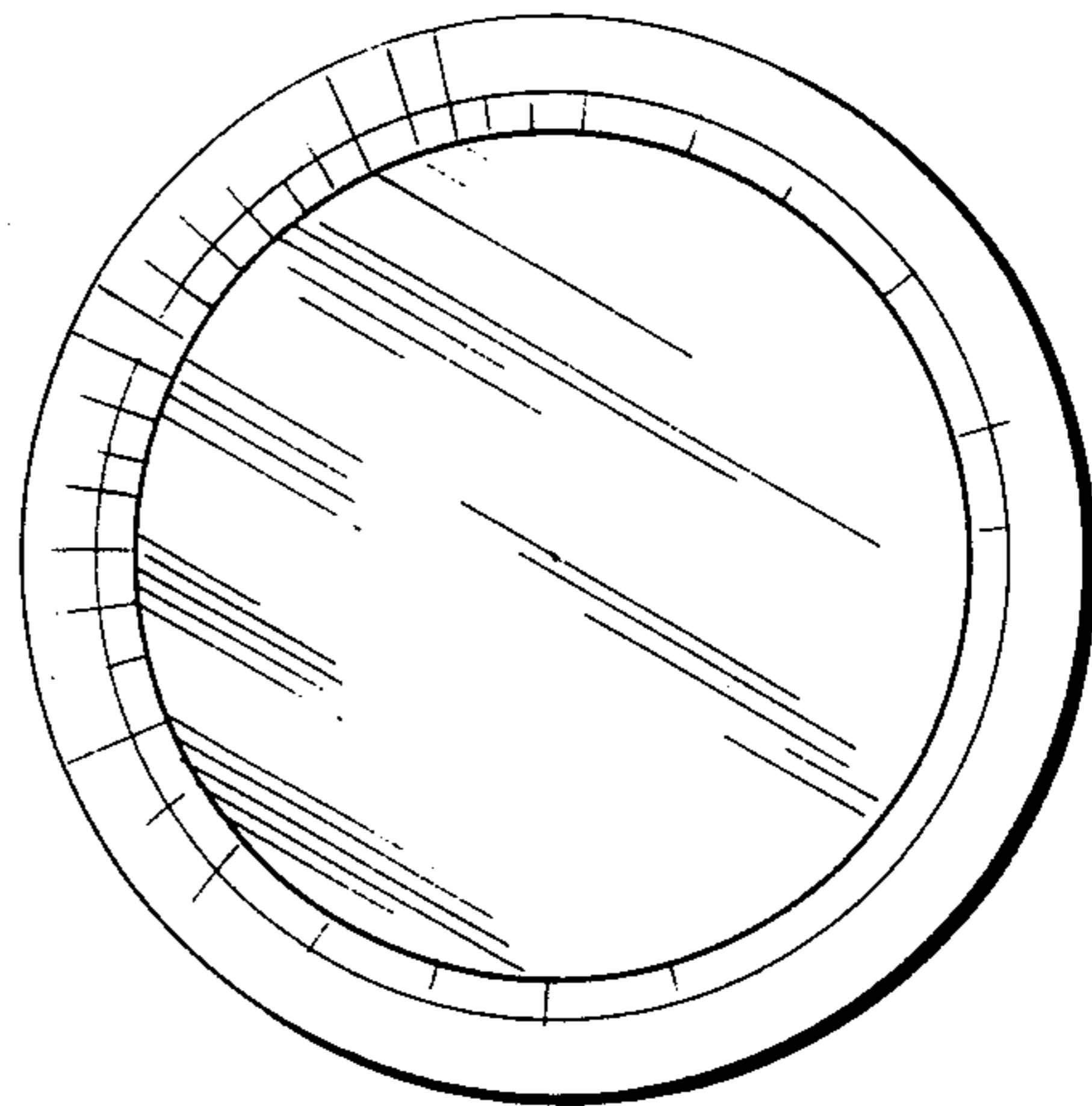

*FIG. 7*

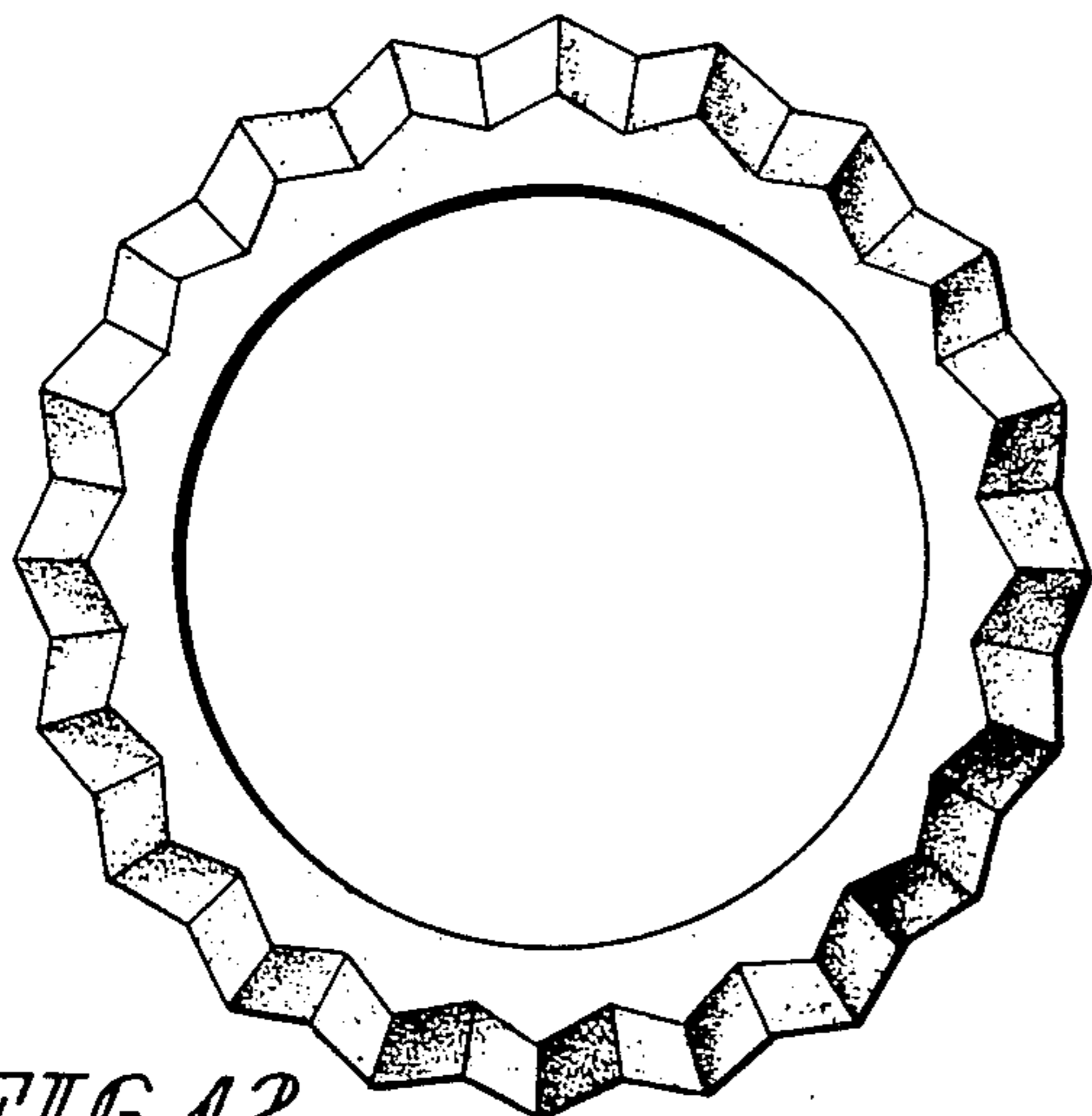

FIG. 12

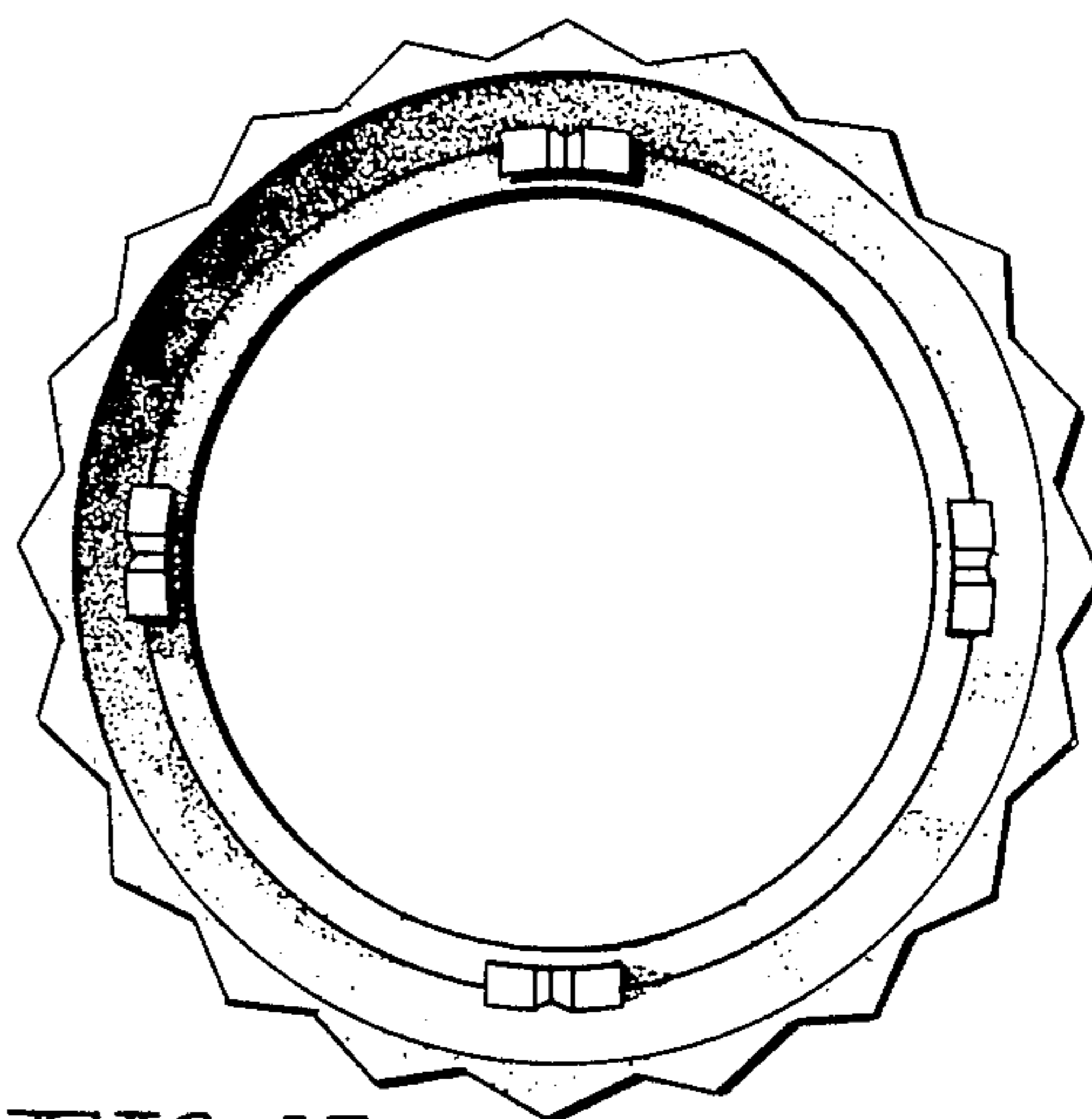

FIG. 13

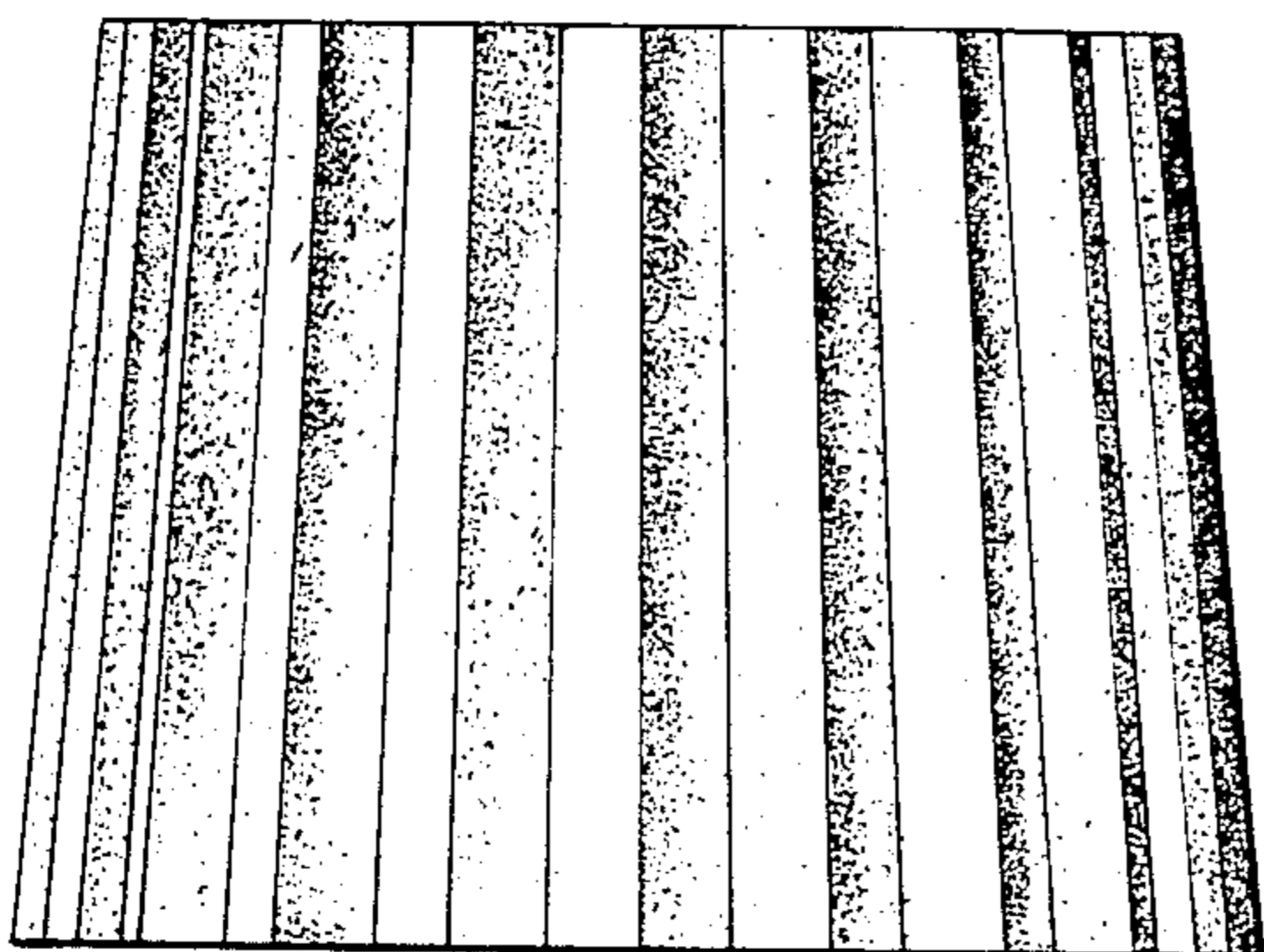

FIG. 11

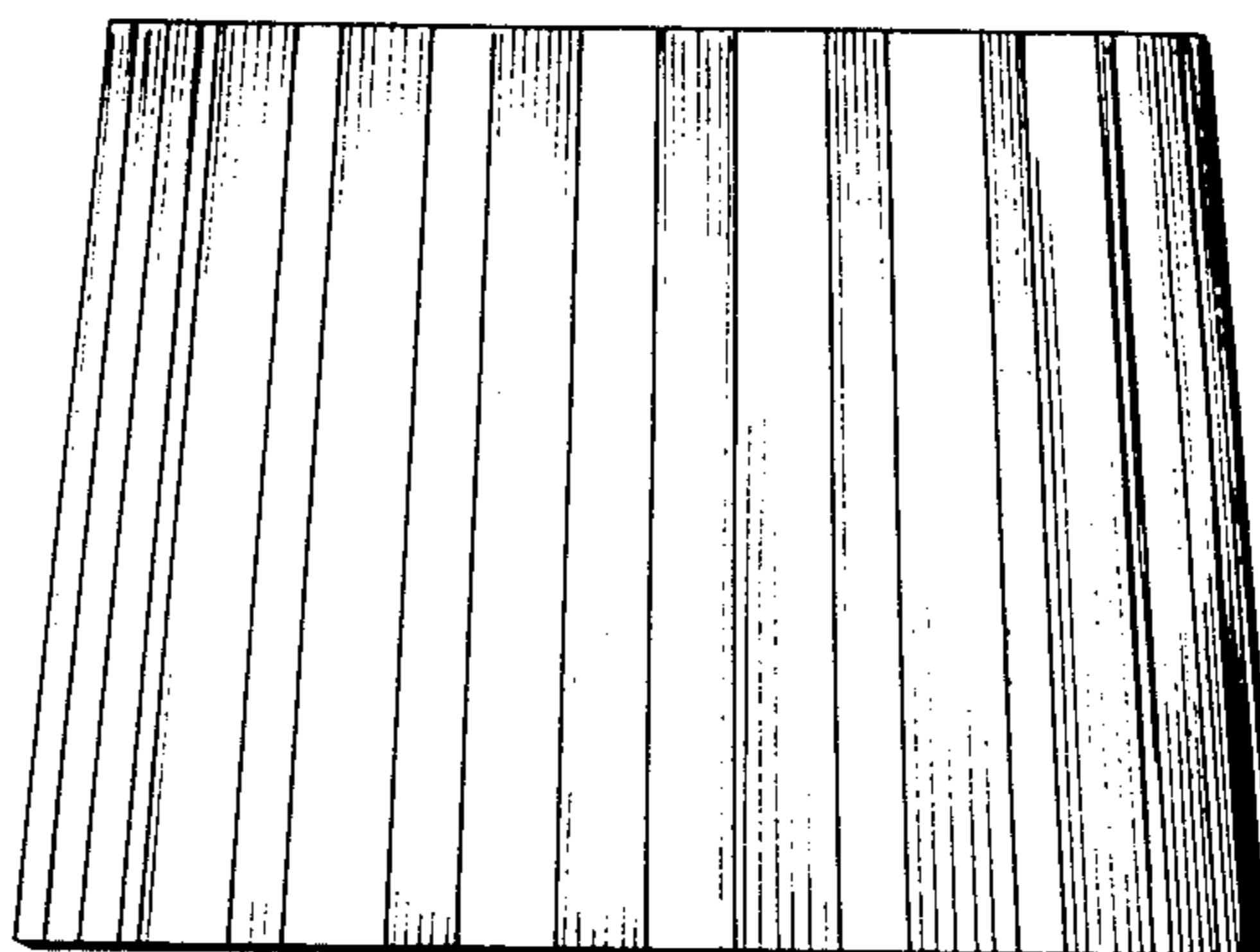

FIG. 14

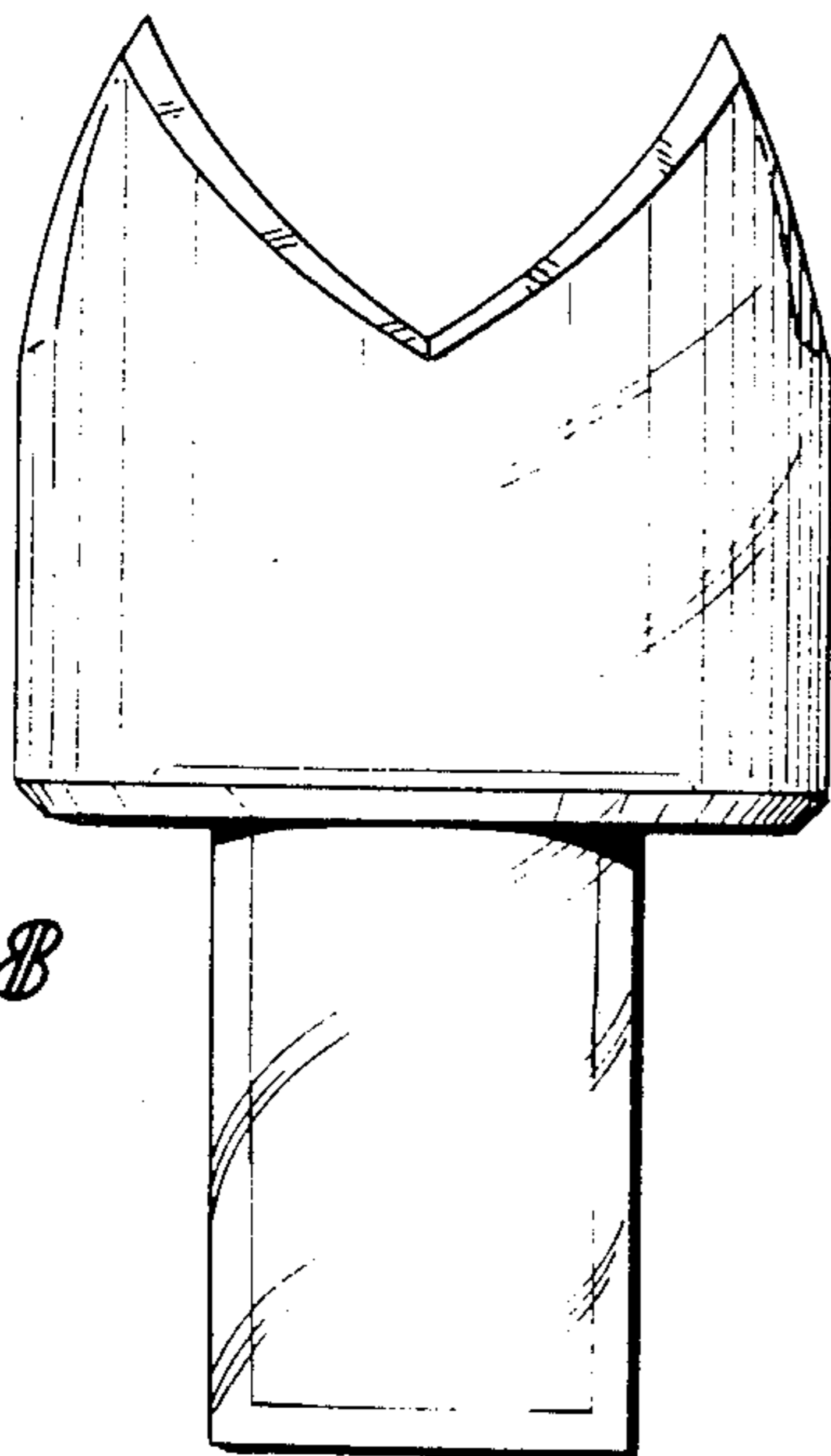

FIG. 8

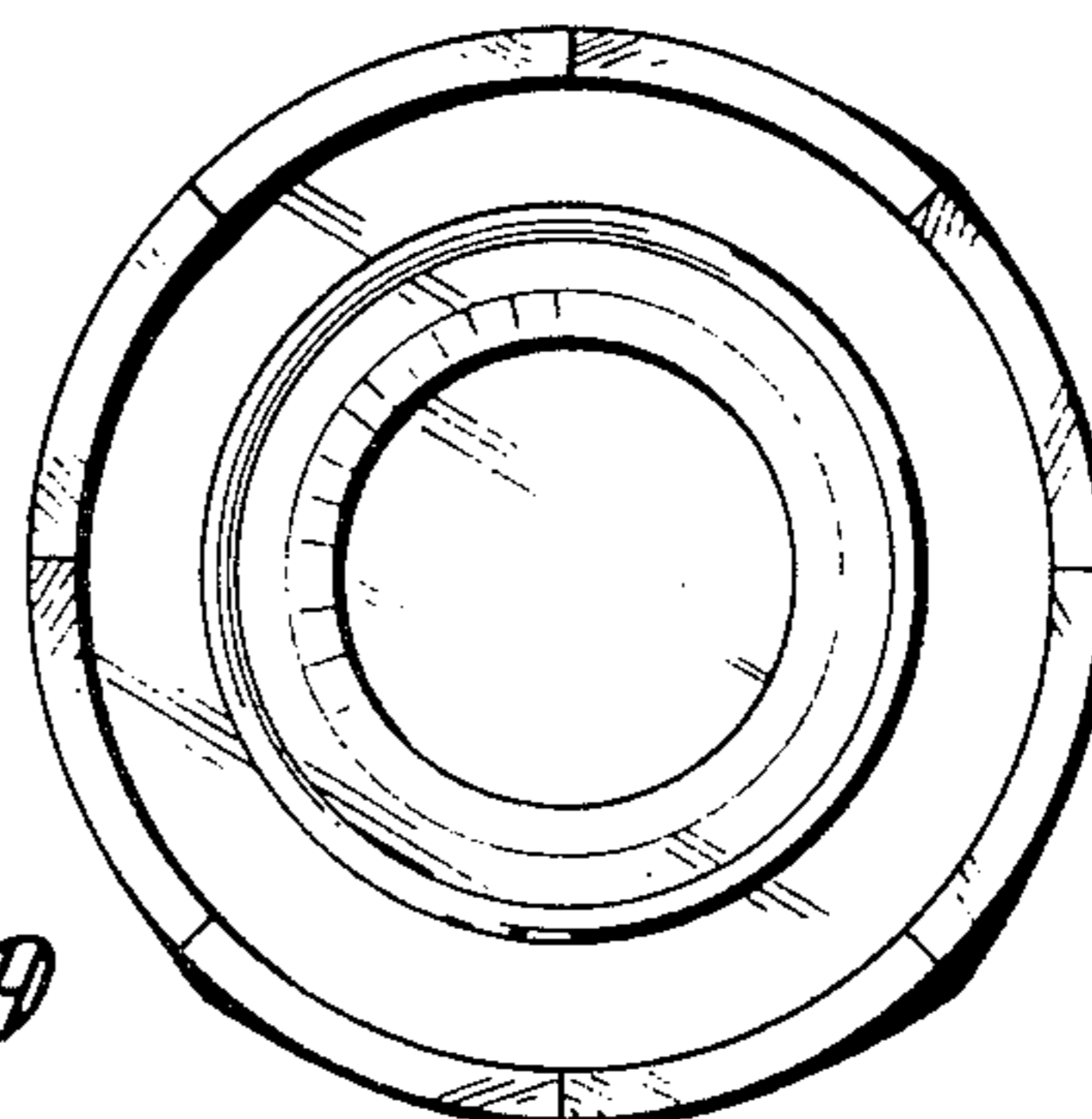

FIG. 9

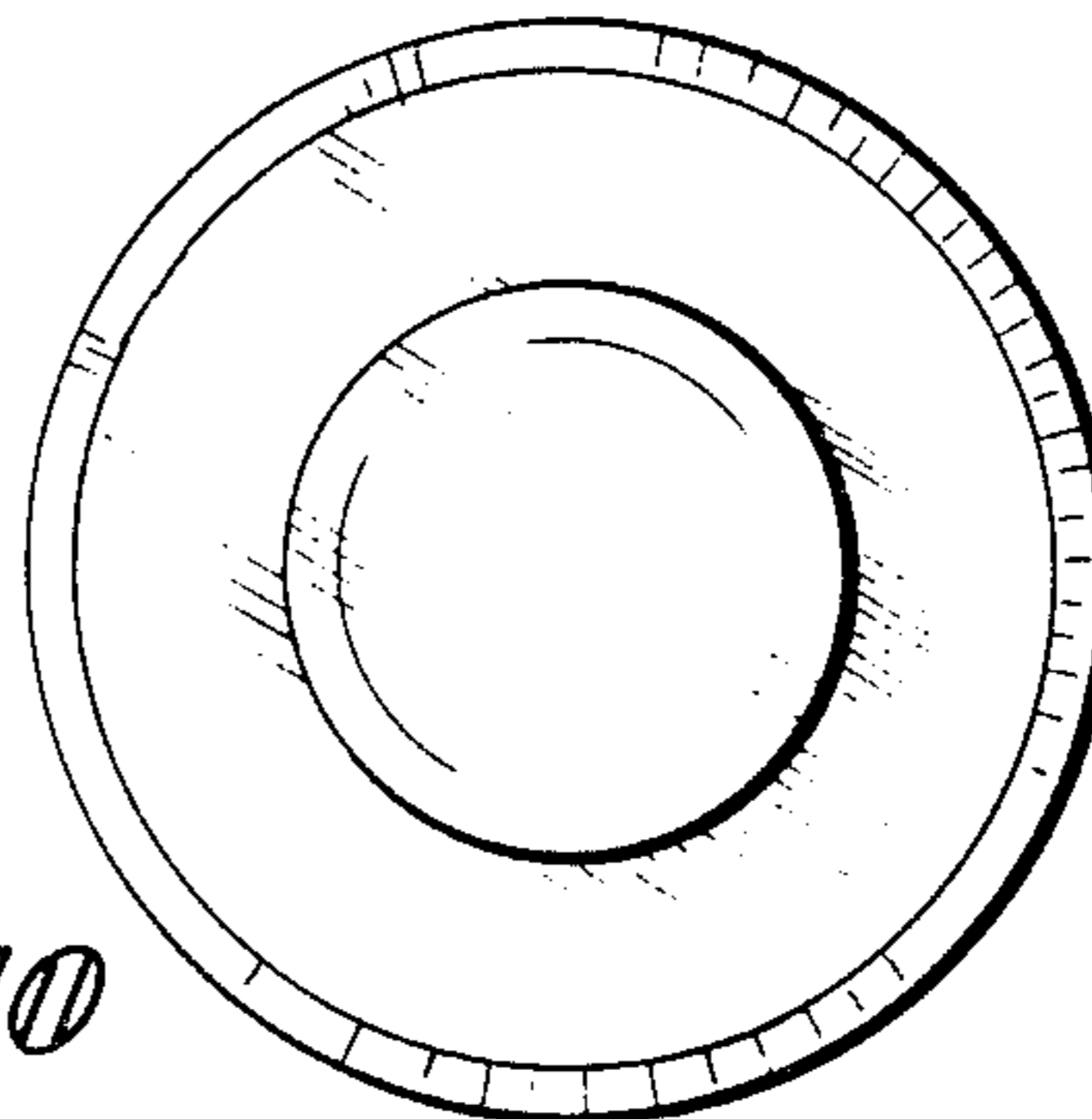

FIG. 10