

[54] OSTEOTOMY STAPLE

[75] Inventors: Clyde R. Pratt, Somis; Roger G. Carignan, Ventura, both of Calif.

[73] Assignee: Techmedica, Inc., Camarillo, Calif.

[**] Term: 14 Years

[21] Appl. No.: 513,381

[22] Filed: Jul. 13, 1983

Related U.S. Application Data

[63] Continuation-in-part of Ser. No. 368,653, Apr. 15, 1982, abandoned.

[52] U.S. Cl. D24/27; D24/29

[58] Field of Search 128/334 R-337; D24/29, 26, 27, 28; D8/390, 393; 411/457, 92 B

[56] References Cited

U.S. PATENT DOCUMENTS

D. 227,976	7/1973	Barth et al.	D8/390
262,635	8/1882	Adams	411/457
2,745,308	5/1956	Gisoni	128/92 B
4,014,244	3/1977	Larson	D8/390 X
4,278,091	7/1981	Borzone	128/334 C

OTHER PUBLICATIONS

The Journal of Bone and Joint Surgery, vol. 52-A, No. 8, Dec. 1970, p. 15, Item No. 821-Barbed Staple.

Primary Examiner—A. Hugo Word
Attorney, Agent, or Firm—Cislo, O'Reilly & Thomas

[57] CLAIM

The ornamental design for an osteotomy staple, as shown and described.

DESCRIPTION

FIG. 1 is a perspective view of a medical staple showing our new design;
 FIG. 2 is a front elevational view thereof;
 FIG. 3 is a side elevational view thereof;
 FIG. 4 is a top plan view thereof;
 FIG. 5 is a bottom plan view thereof;
 FIG. 6 is an alternate perspective view similar to FIG. 1;
 FIG. 7 is a front elevational view of the device shown in FIG. 6;
 FIG. 8 is a right side elevational view of the device shown in FIG. 6;
 FIG. 9 is a left side elevational view of the device shown in FIG. 6;
 FIG. 10 is a top plan view of the device shown in FIG. 6;
 FIG. 11 is a bottom plan view of the device shown in FIG. 6;
 FIG. 12 is an alternate perspective view of a device, which device is similar to that shown in FIG. 6;
 FIG. 13 is a front elevational view of an alternate device;
 FIG. 14 is right side elevational view of the device shown in FIG. 13;
 FIG. 15 is a top plan view of the device shown in FIG. 13; and
 FIG. 16 is a bottom view of the device shown in FIG. 13.

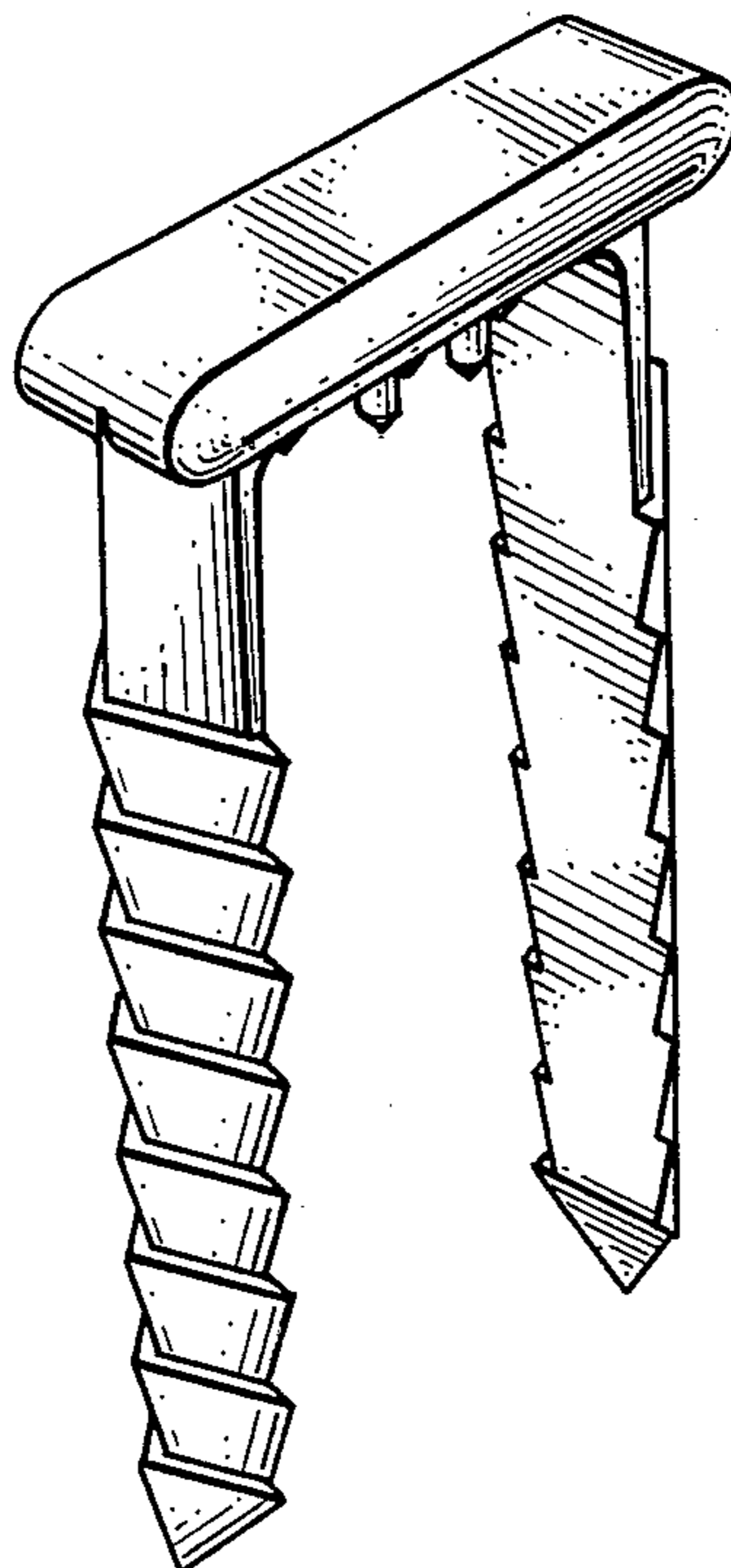

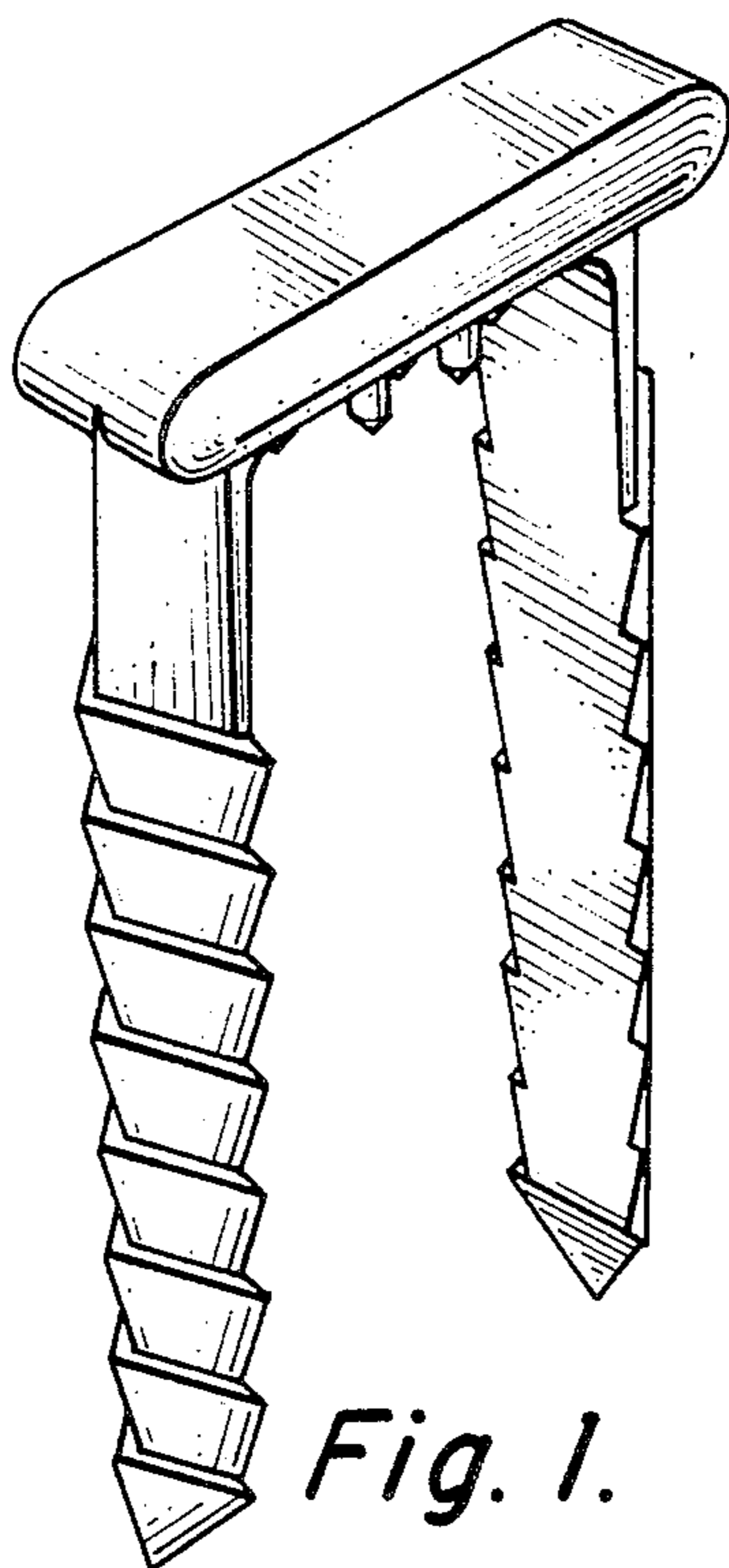

Fig. 1.

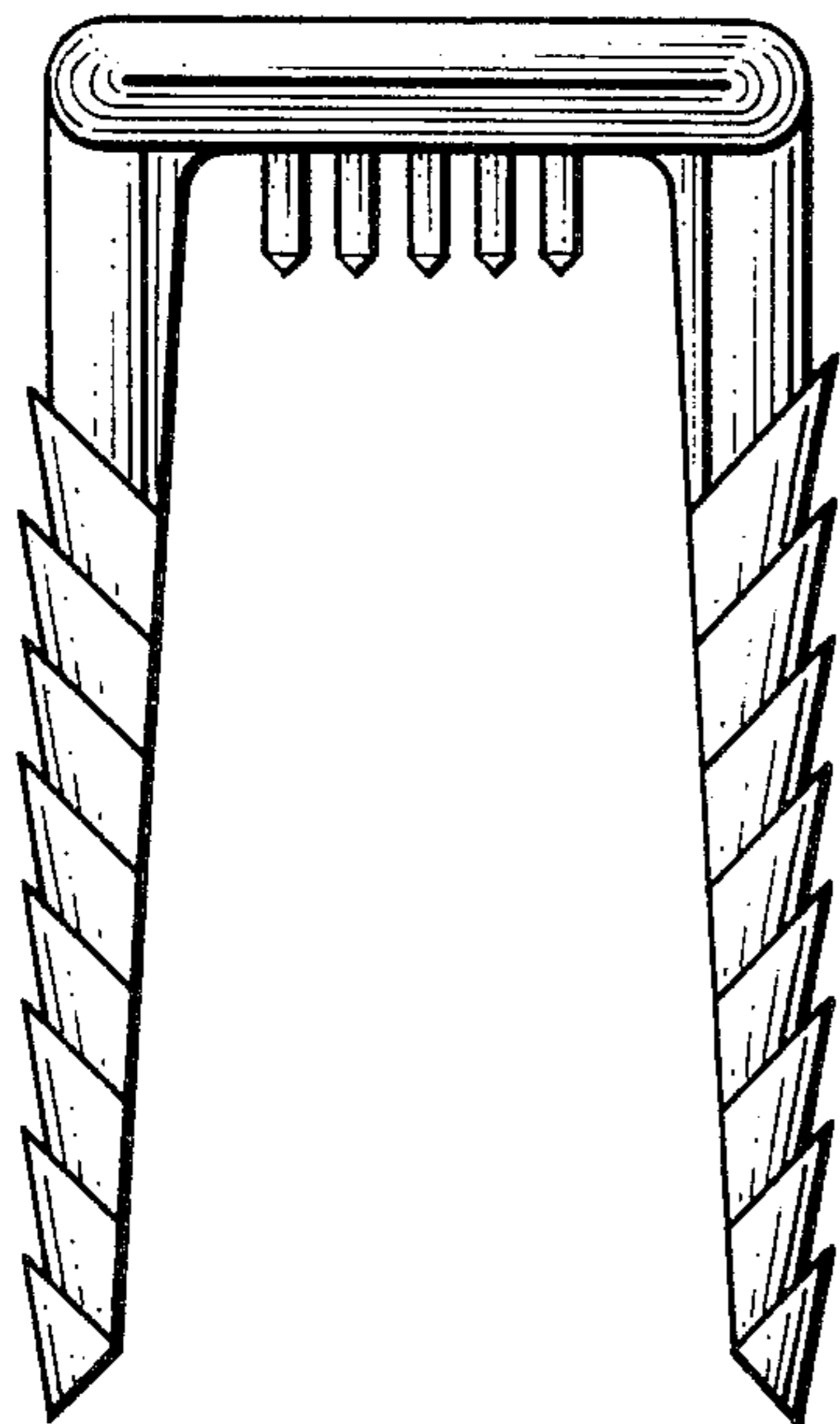

Fig. 2.

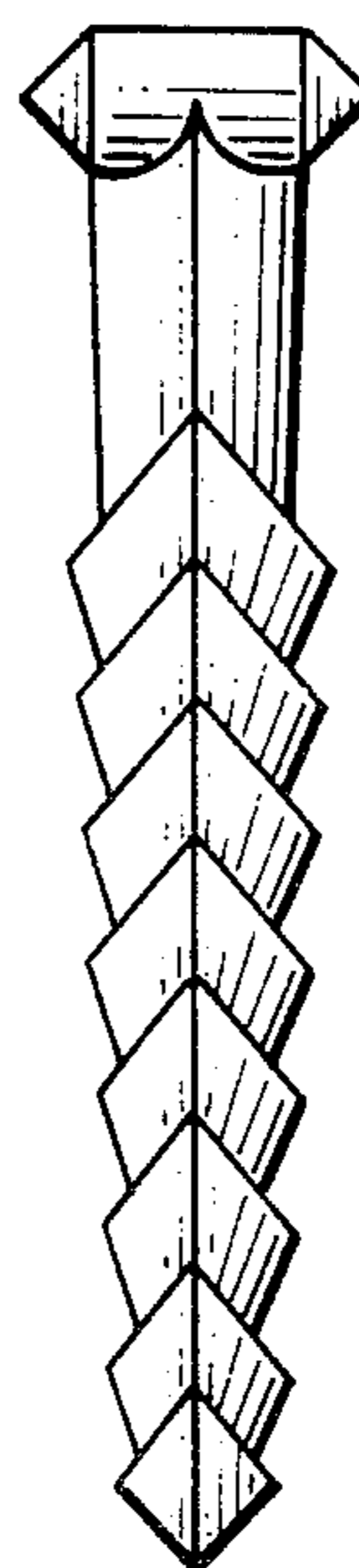

Fig. 3.

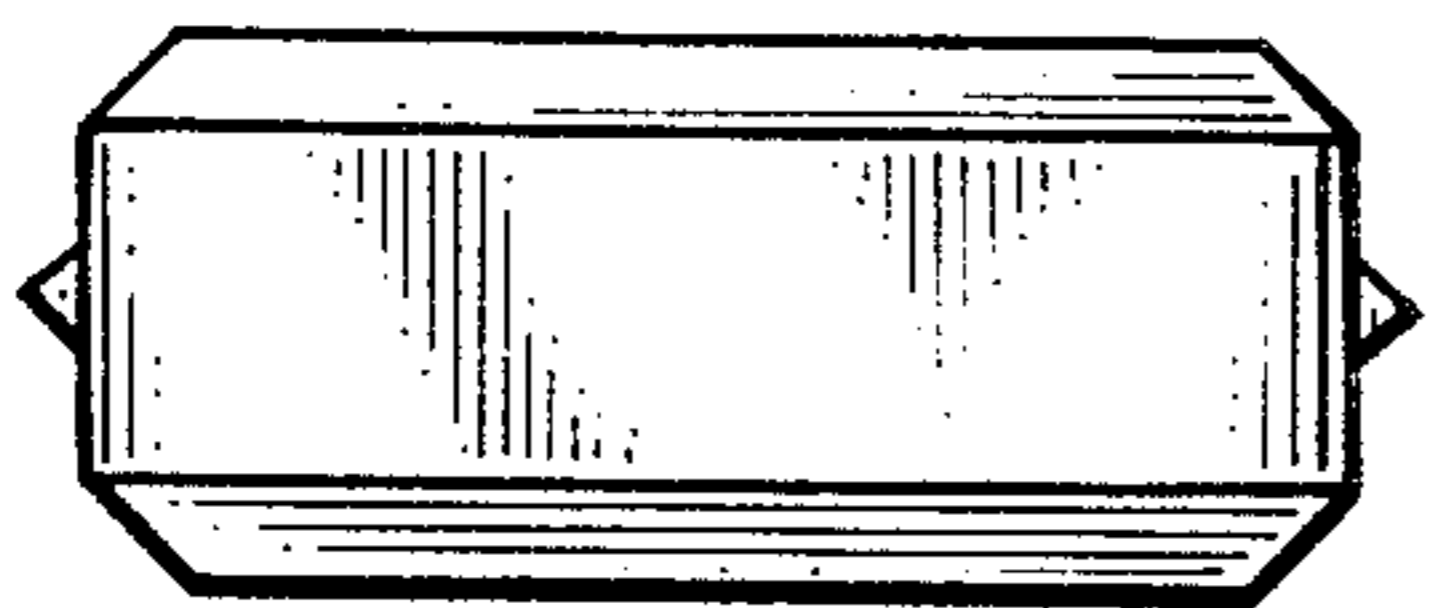

Fig. 4.

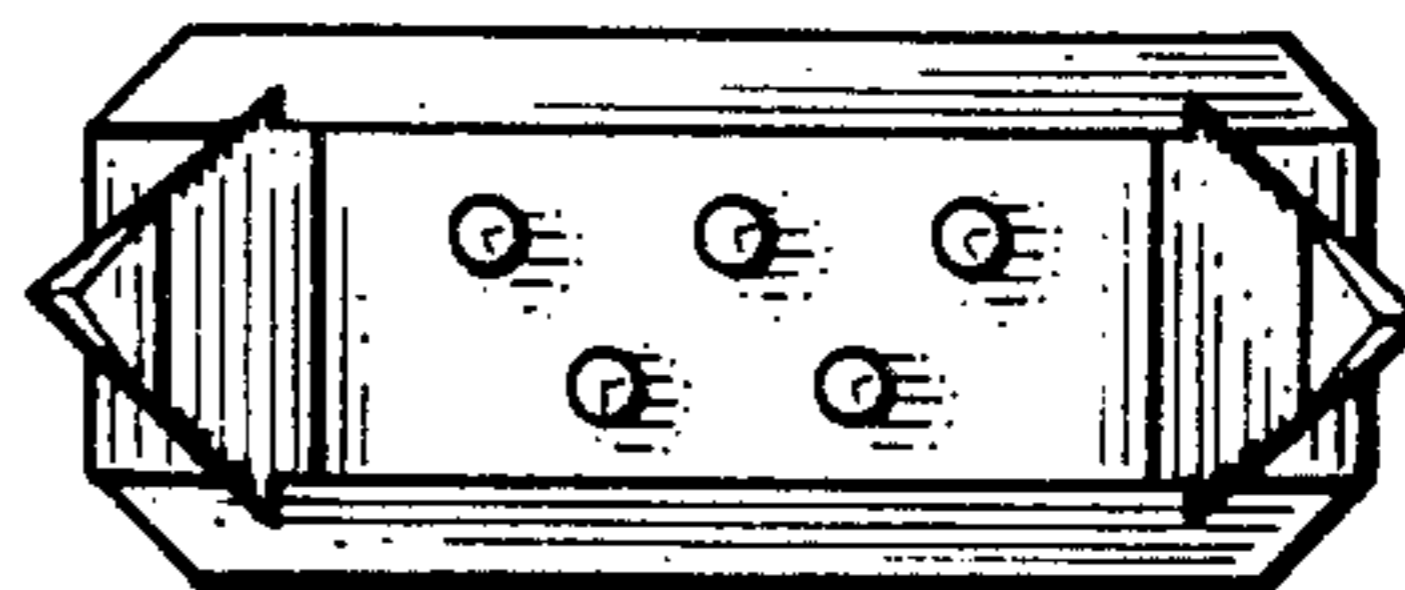

Fig. 5.

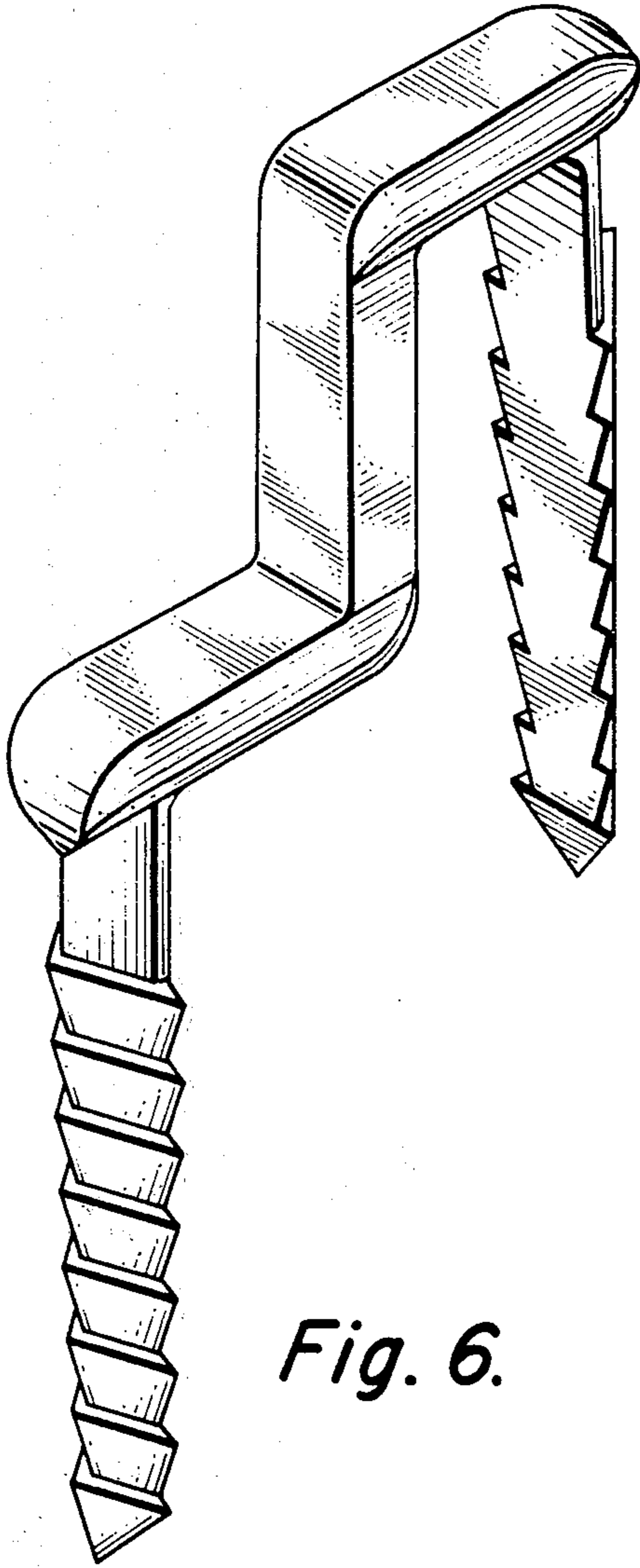

Fig. 6.

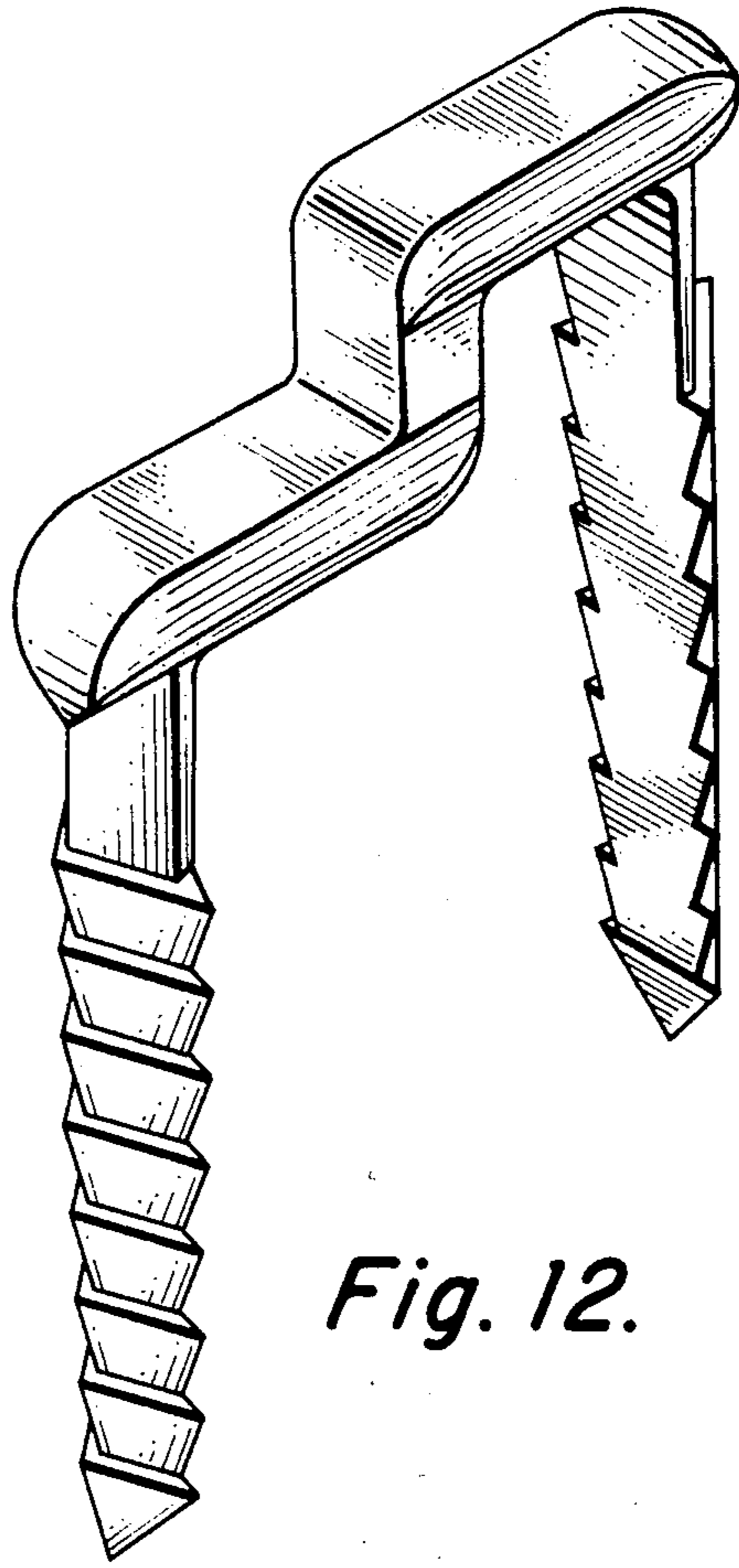

Fig. 12.

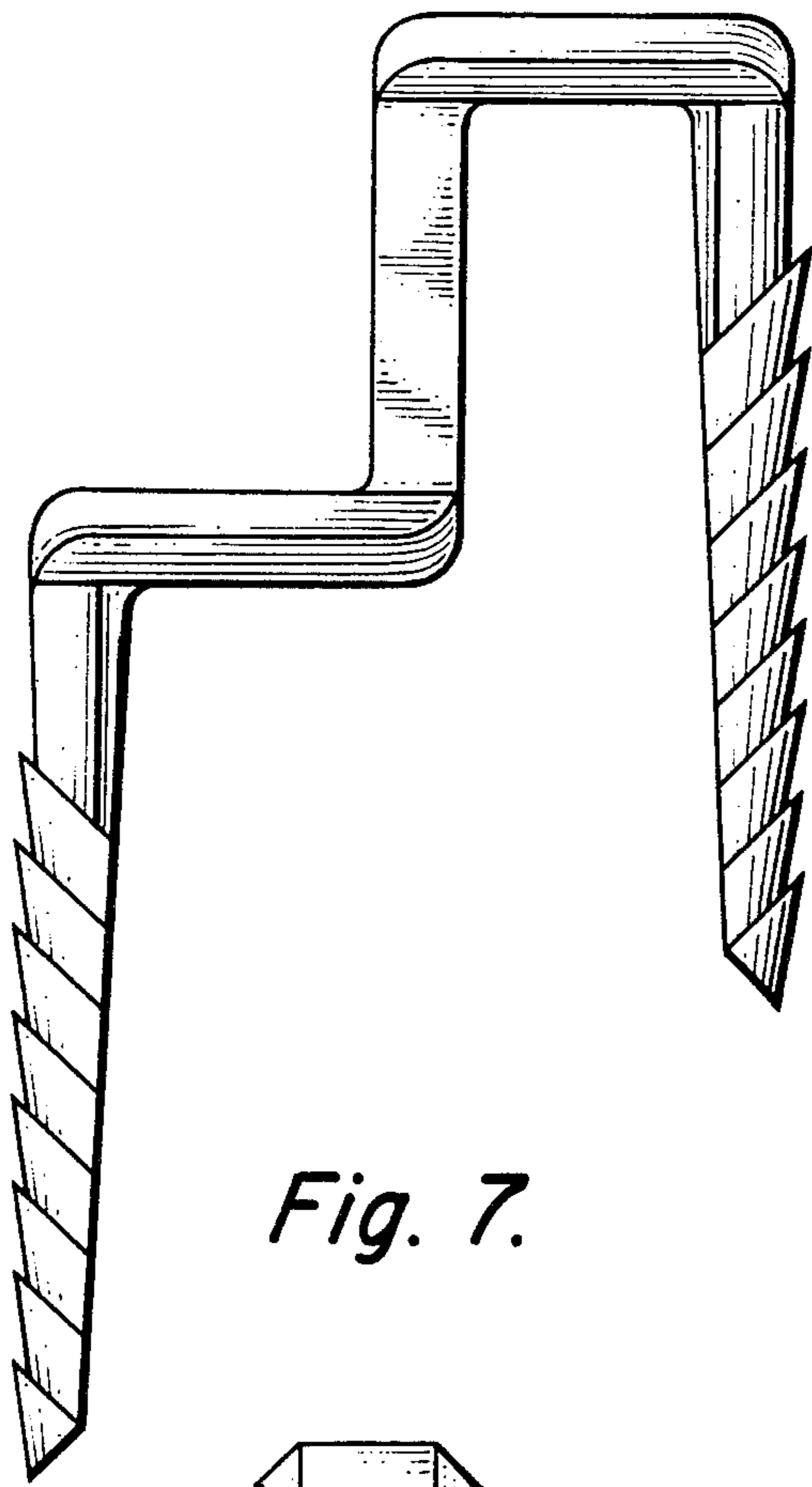

Fig. 7.

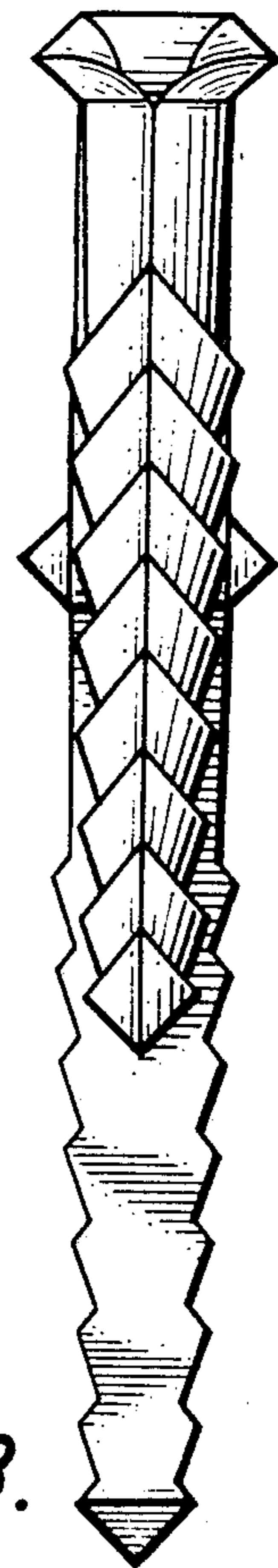

Fig. 8.

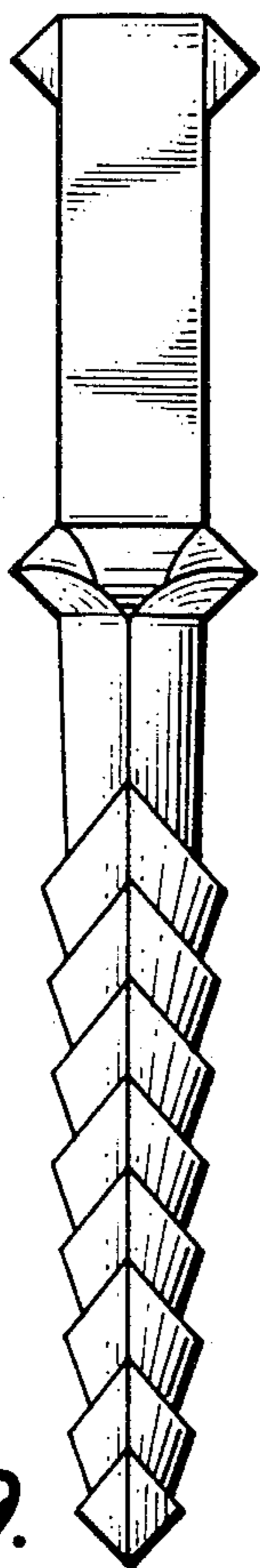

Fig. 9.

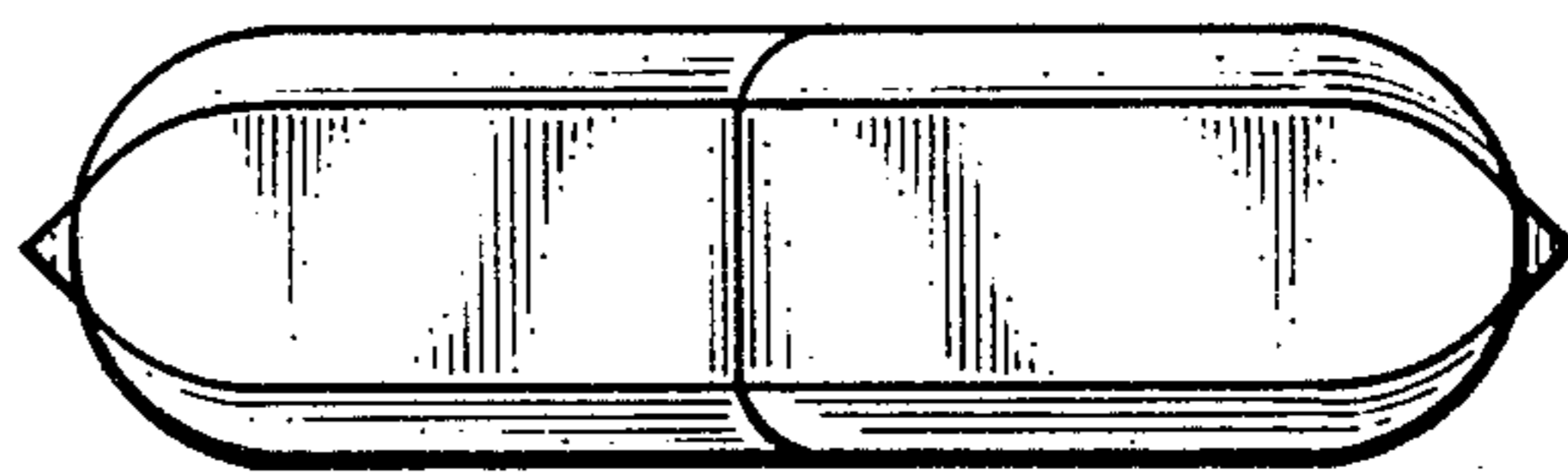

Fig. 10.



Fig. 11.

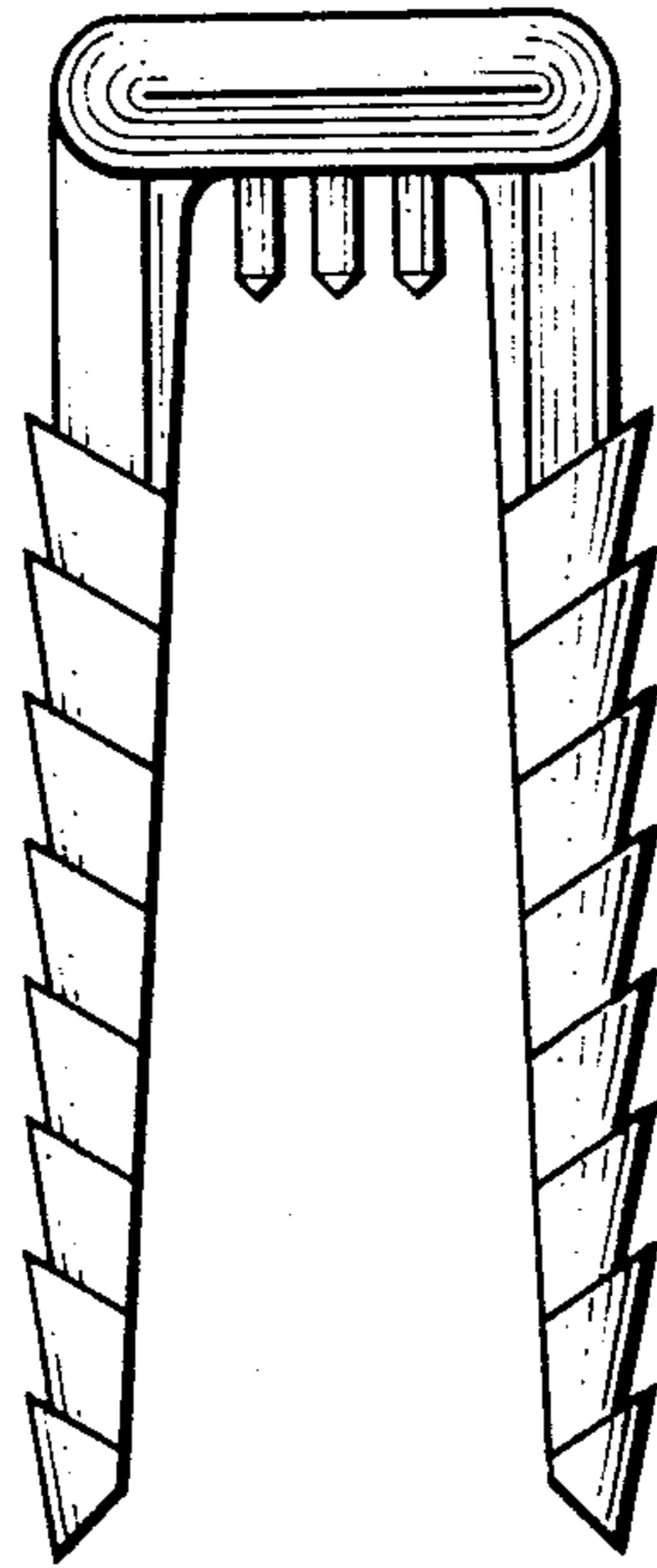

Fig. 13.

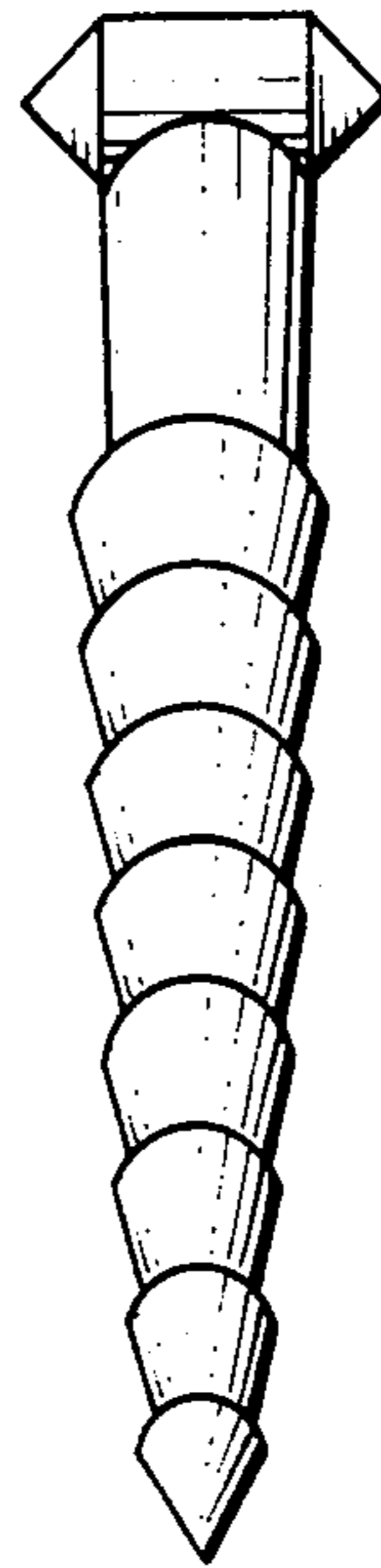

Fig. 14.

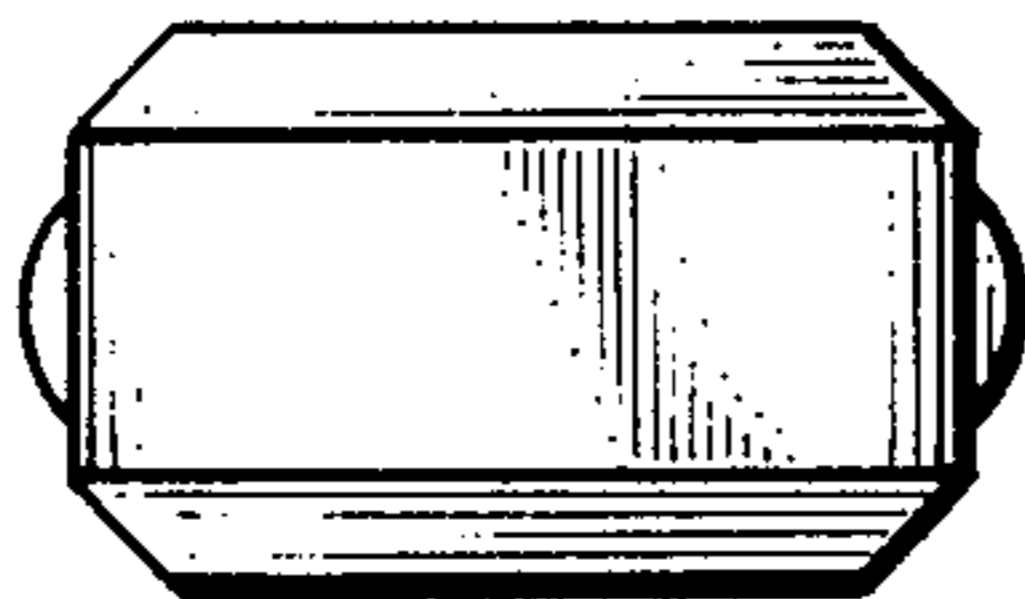

Fig. 15.

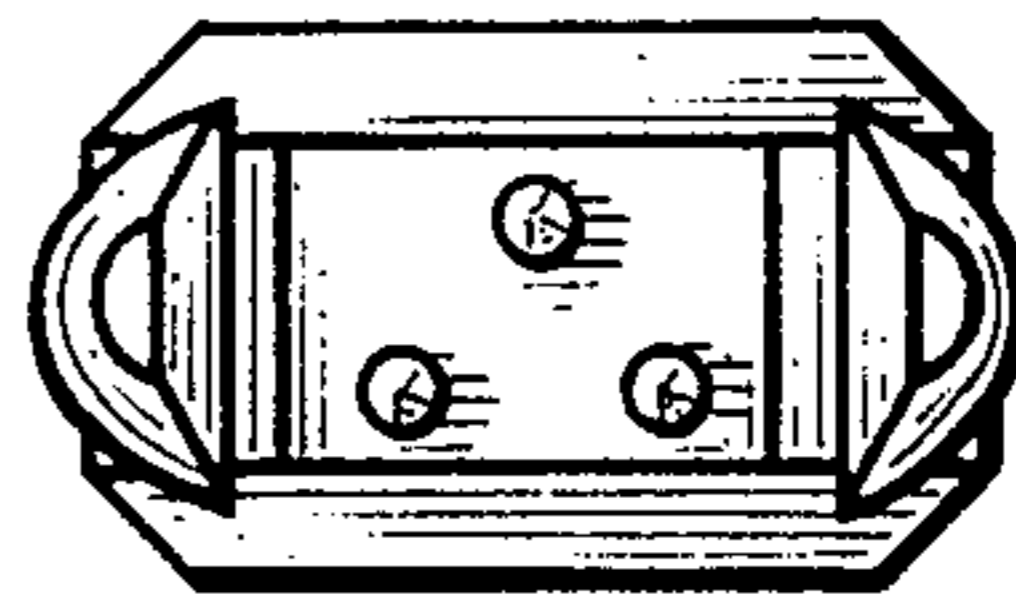

Fig. 16.