

[54] TOY MOTORCYCLE

[75] Inventor: Toshimasa Shimomura, Toyonaka, Japan

[73] Assignee: Tonan Merchandise Inc., Osaka, Japan

[**] Term: 14 Years

[21] Appl. No.: 570,531

[22] Filed: Jan. 13, 1984

[52] U.S. Cl. D21/134

[58] Field of Search D21/71, 73, 74, 76, D21/78, 81, 128, 130, 134, 135, 136, 137, 140; 446/88, 465, 469, 470, 471; D12/110

[56] References Cited

U.S. PATENT DOCUMENTS

- D. 208,484 9/1967 Wetherell D21/134
- D. 268,772 4/1983 Hanzawa D12/110
- D. 271,956 12/1983 Morioka et al. D12/110

- D. 274,610 7/1984 Schulz D12/110
- D. 276,251 11/1984 Wakimura D21/134

OTHER PUBLICATIONS

Stile Industria, 2-1962, p. 17, Motorcycle.

Primary Examiner—Charles A. Rademaker
Attorney, Agent, or Firm—Koda and Androlia

[57] CLAIM

The ornamental design for a toy motorcycle, as substantially shown and described.

DESCRIPTION

FIG. 1 is a perspective view of a toy motorcycle showing my new design;
 FIG. 2 is a front elevational view thereof;
 FIG. 3 is a rear elevational view thereof;
 FIG. 4 is a left side elevational view thereof;
 FIG. 5 is a right side elevational view thereof;
 FIG. 6 is a top plan view thereof; and
 FIG. 7 is a bottom plan view thereof.

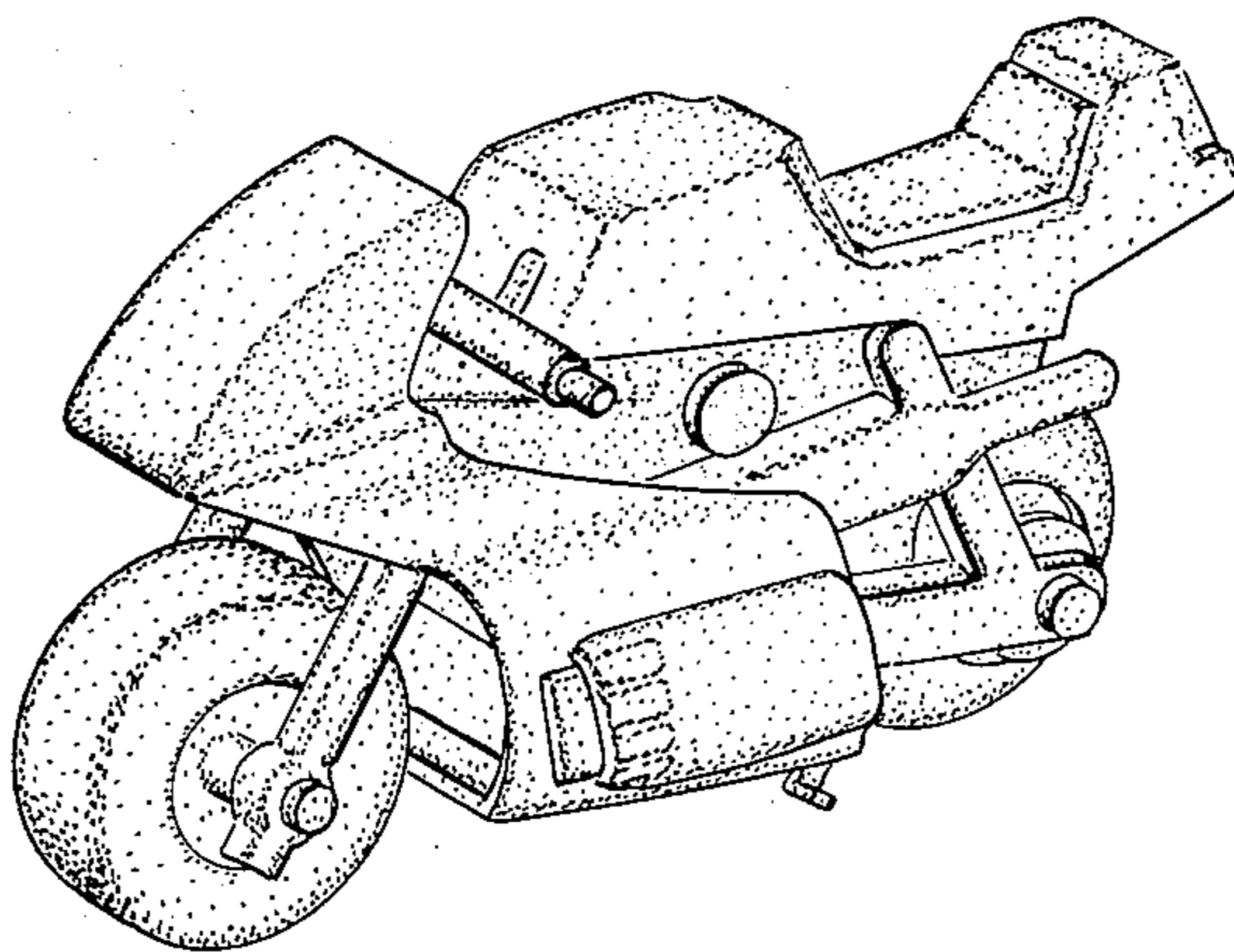

FIG. 1

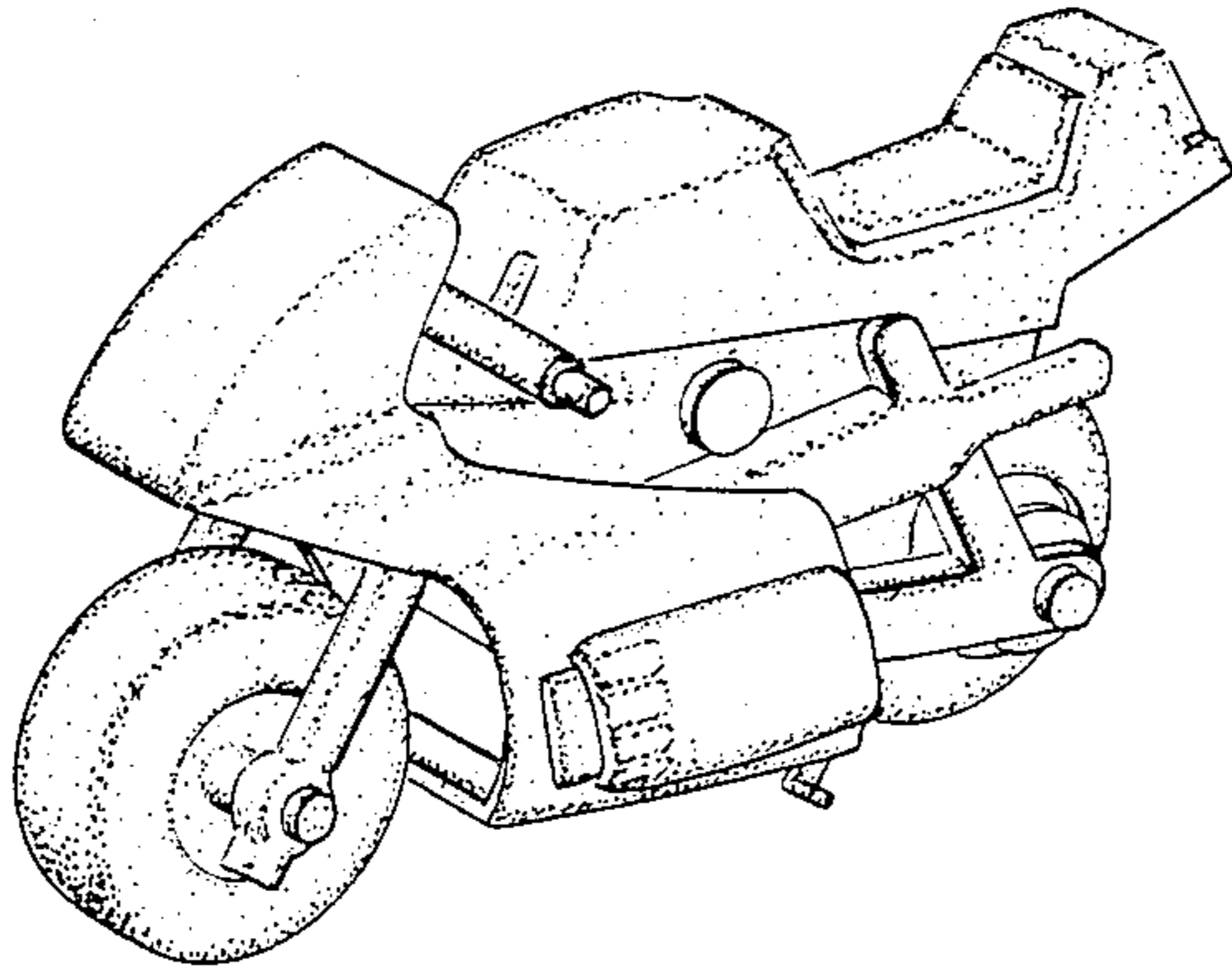

FIG. 2

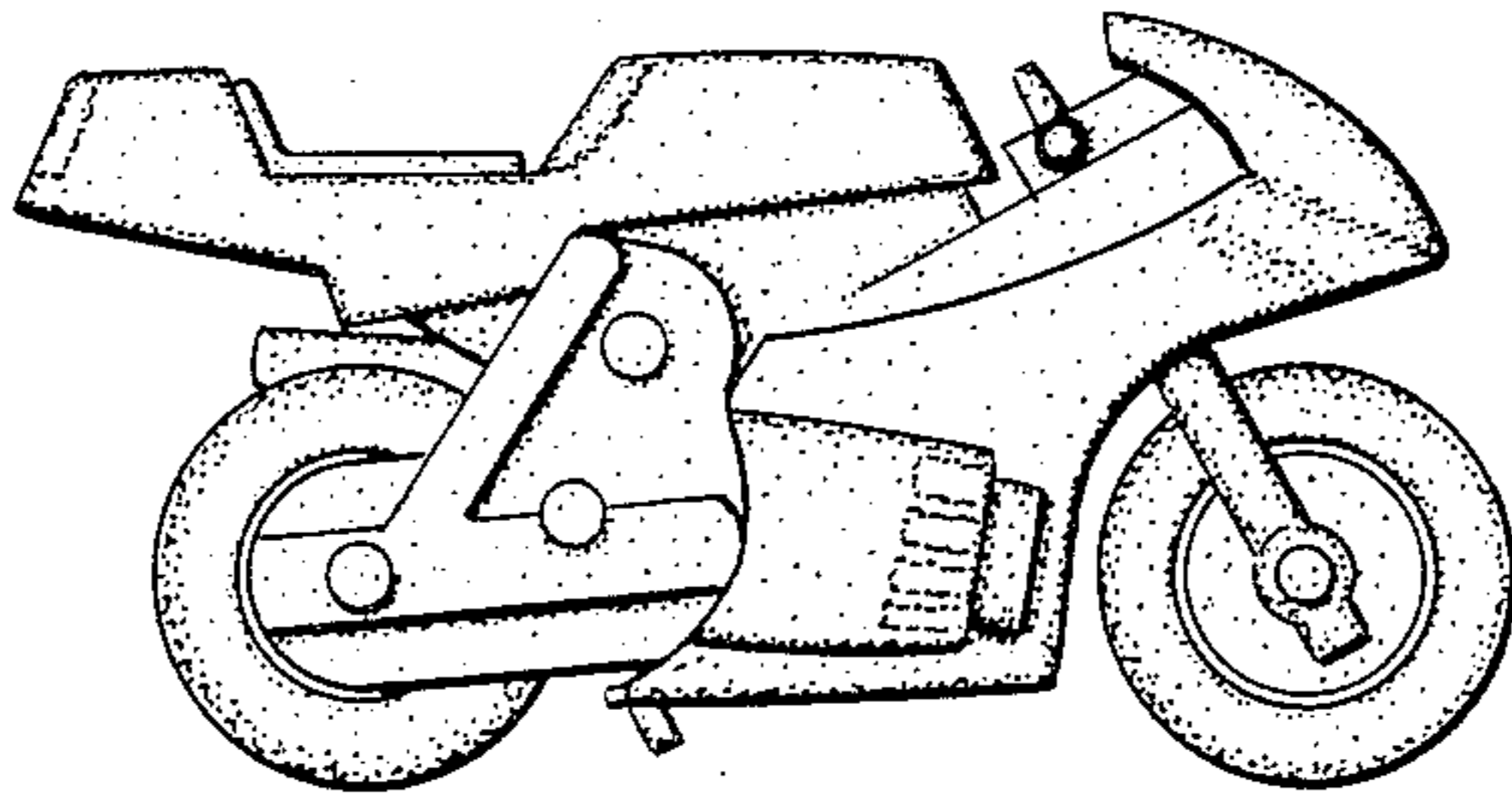
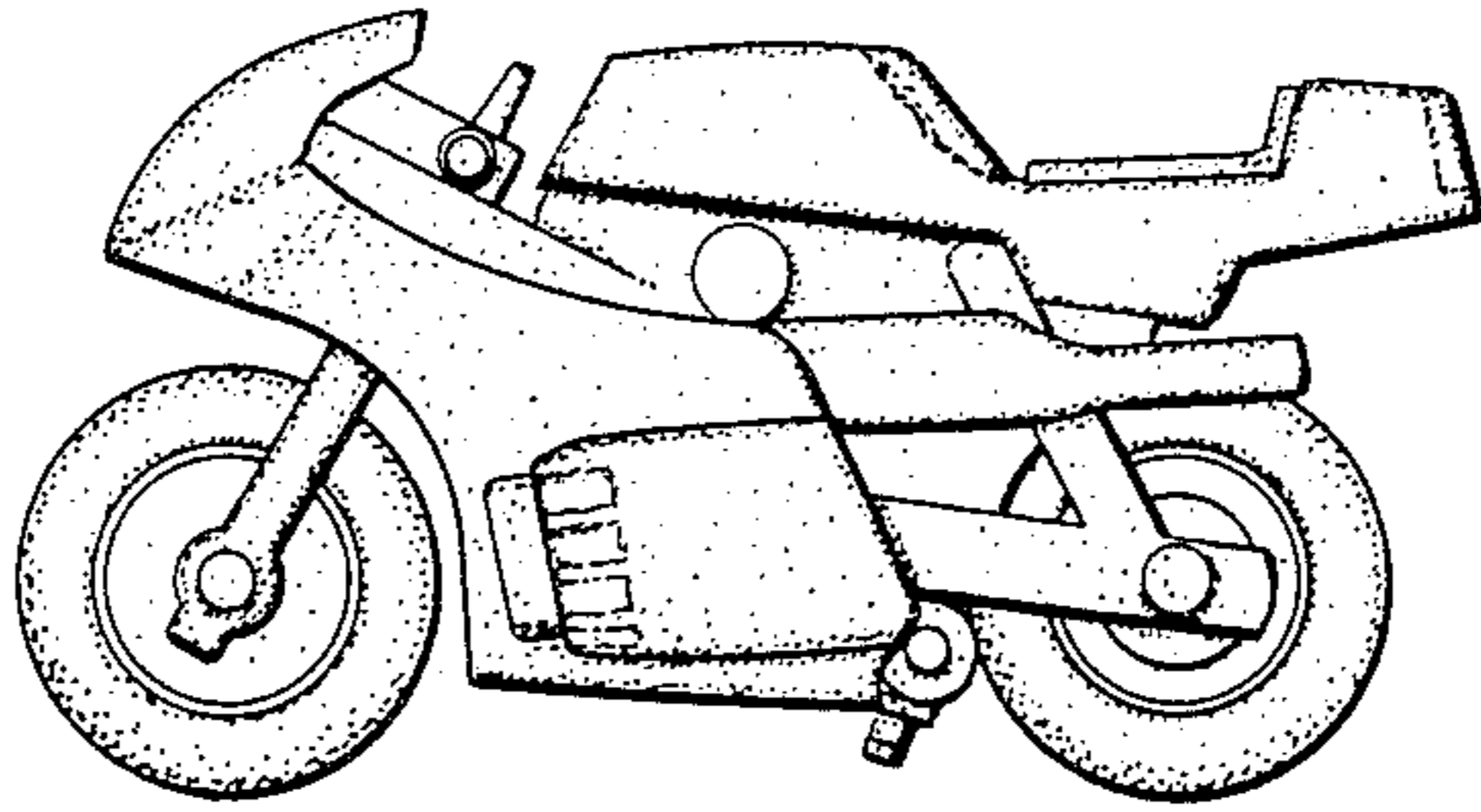

FIG. 3

FIG. 4

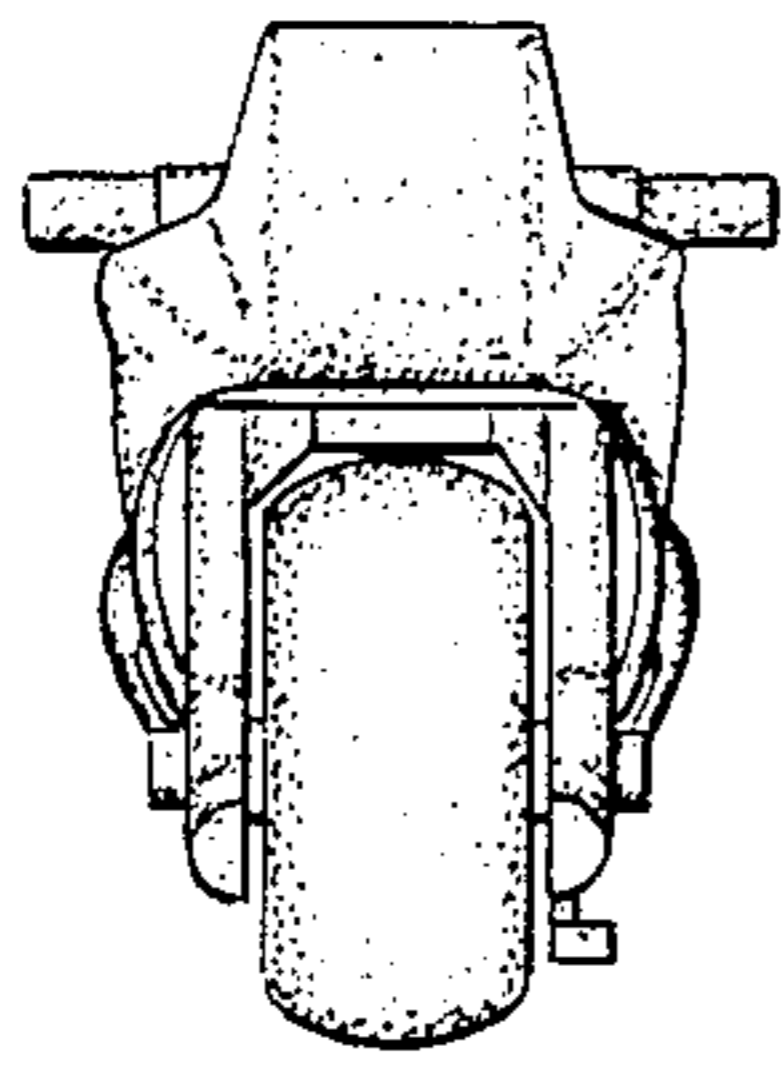

FIG. 5

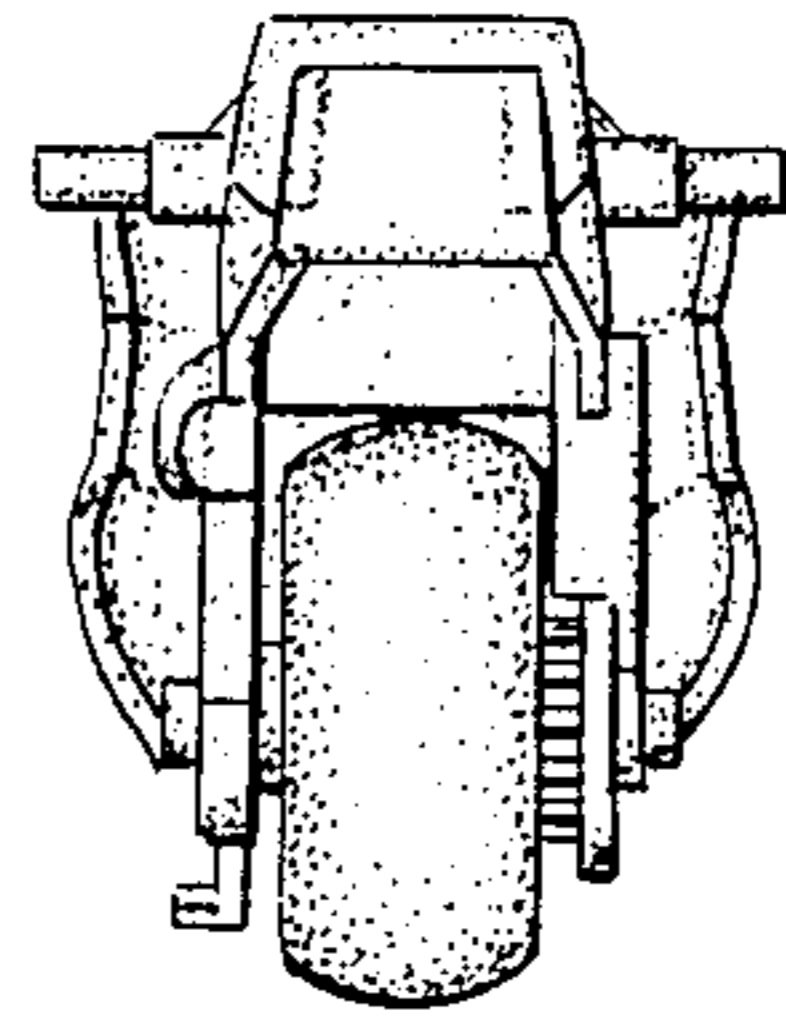

FIG. 6

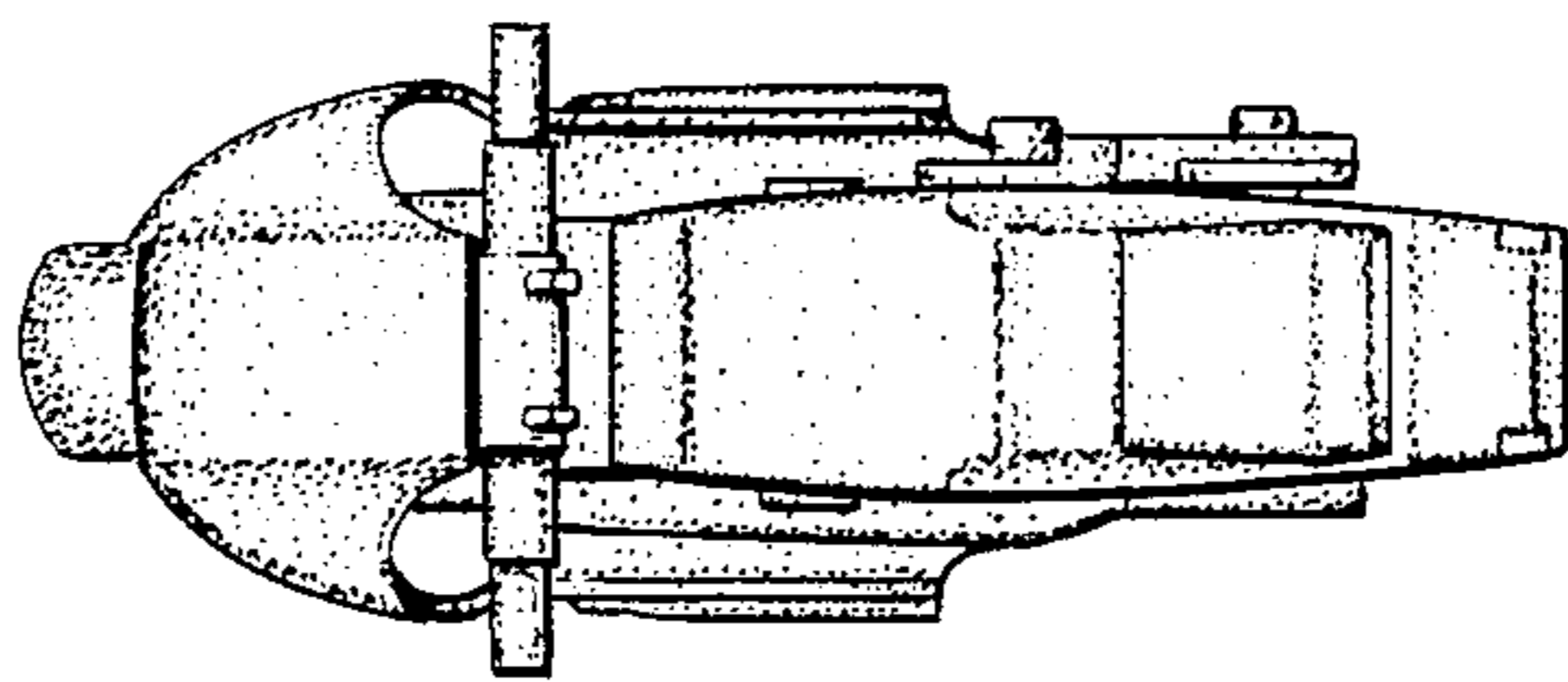

FIG. 7

