

[54] PACKAGING CONTAINER FOR ELECTRICAL SWITCHES

[75] Inventor: James T. Stevens, San Antonio, Tex.

[73] Assignee: Power Controls Corp., San Antonio, Tex.

[**] Term: 14 Years

[21] Appl. No.: 559,957

[22] Filed: Dec. 9, 1983

[52] U.S. Cl. D9/415

[58] Field of Search D9/347, 345, 415; 206/461-471

[56] References Cited

U.S. PATENT DOCUMENTS

- D. 216,251 12/1969 Offray, Jr. D9/415
- 4,383,607 5/1983 Lordahl et al. 206/470 X
- 4,499,353 2/1985 Shields 206/470

Primary Examiner—Robert C. Spangler
Attorney, Agent, or Firm—Gunn, Lee & Jackson

[57] CLAIM

The ornamental design for a packaging container for electrical switches, as shown.

DESCRIPTION

FIG. 1 is a top view of a packaging container for electrical switches showing my new design; FIG. 2 is a side elevational view thereof; FIG. 3 is an end elevational view thereof; FIG. 4 is a perspective view thereof; and FIG. 5 is an opposite end elevational view thereof.

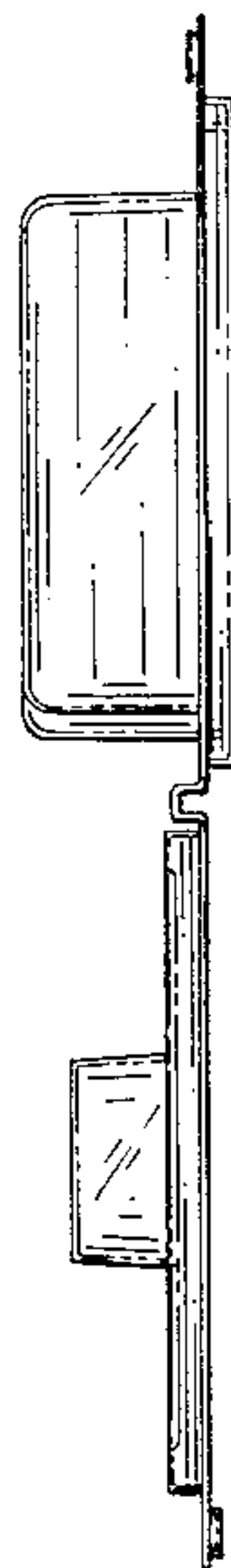
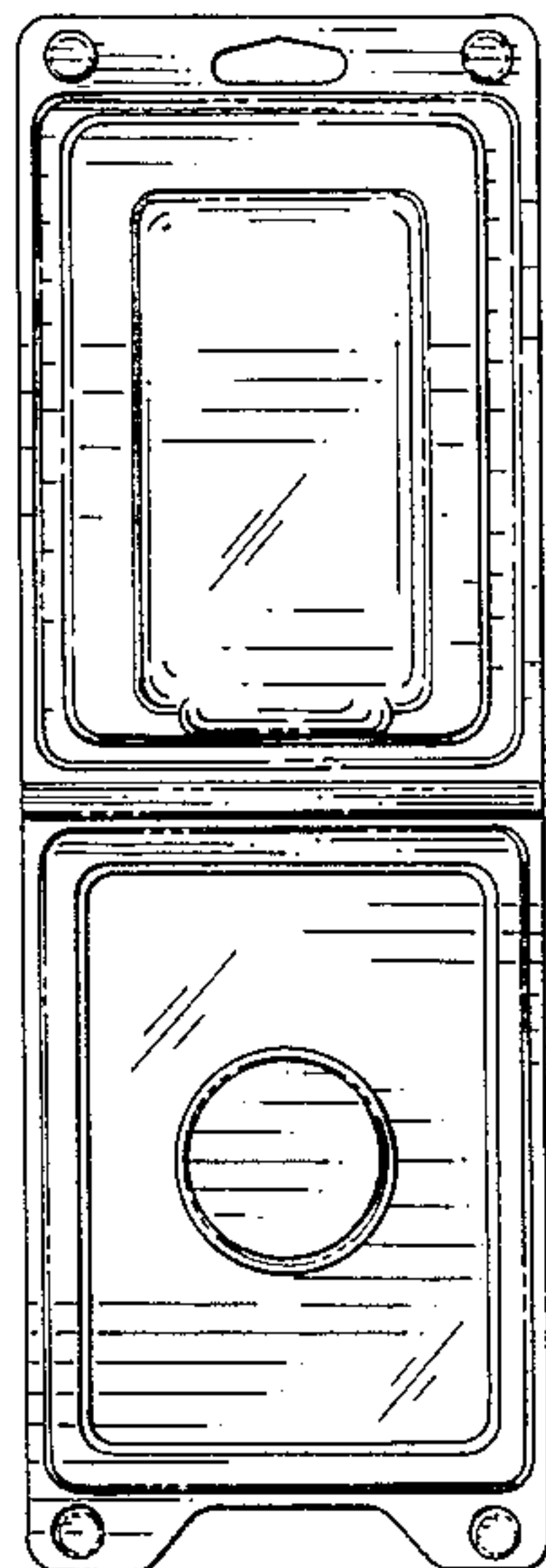

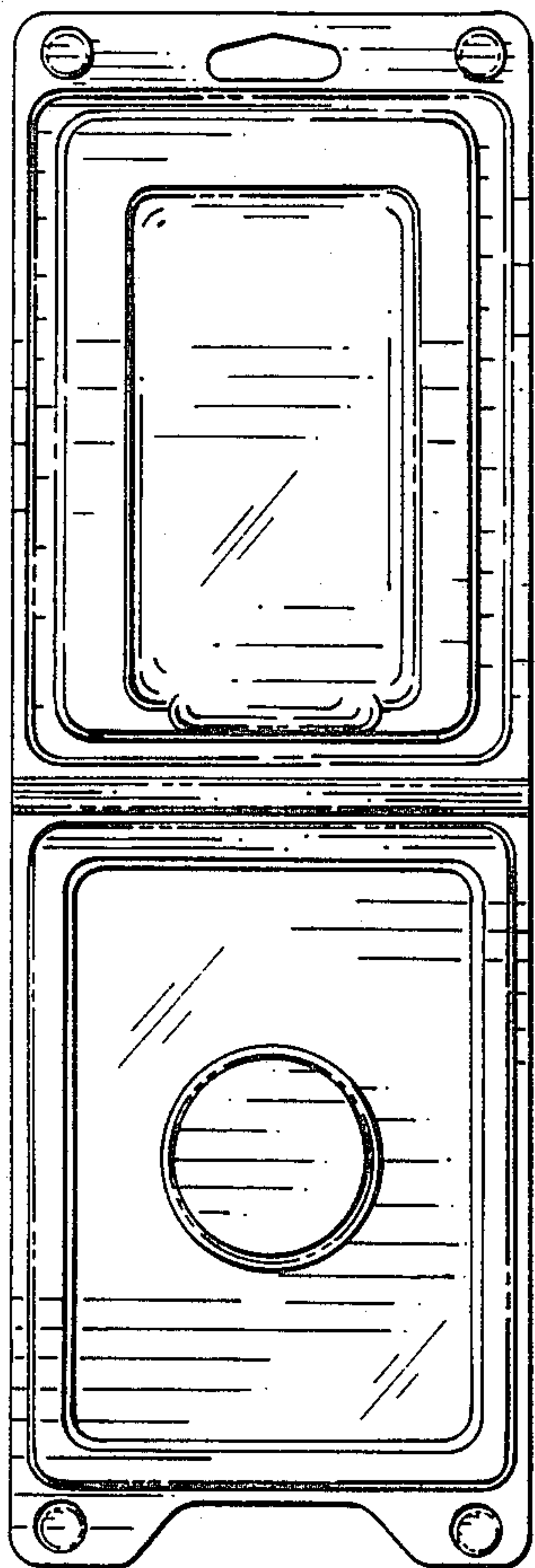

FIG. 1

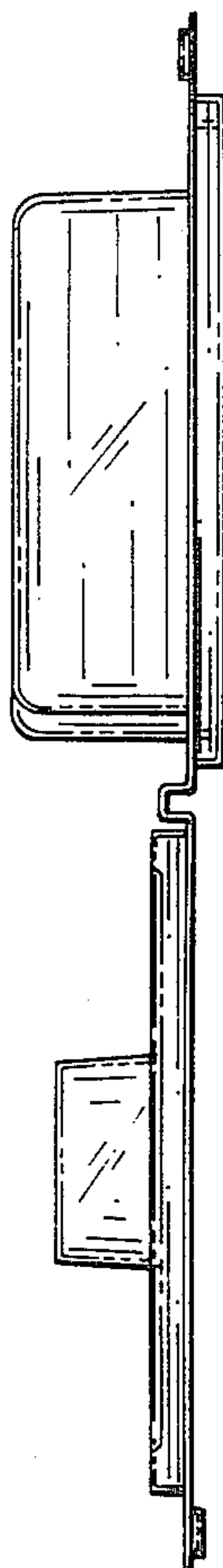

FIG. 2

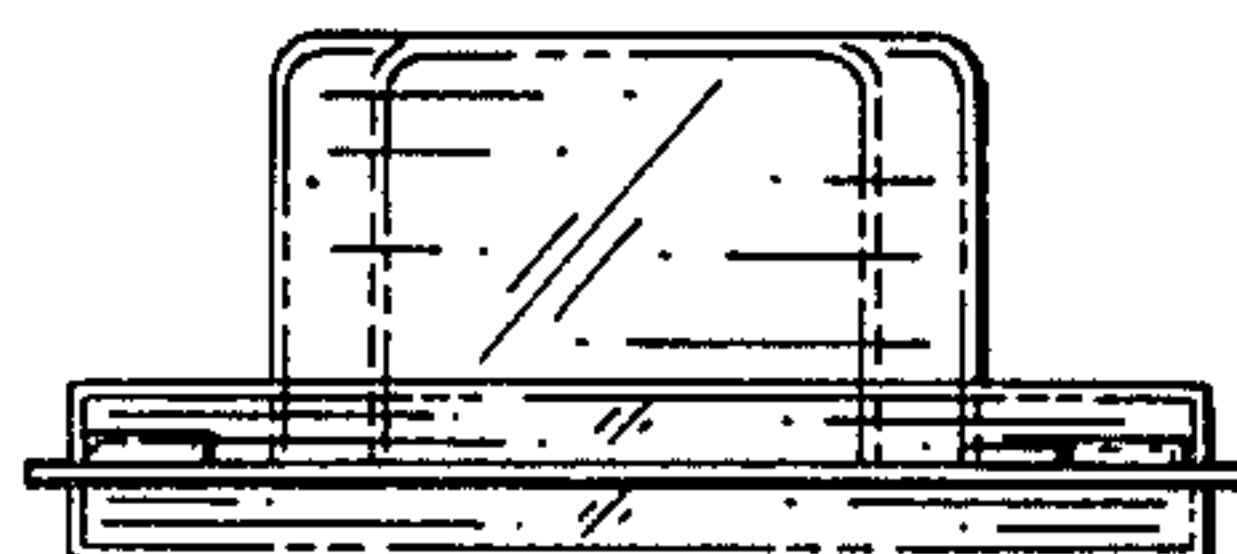

FIG. 5

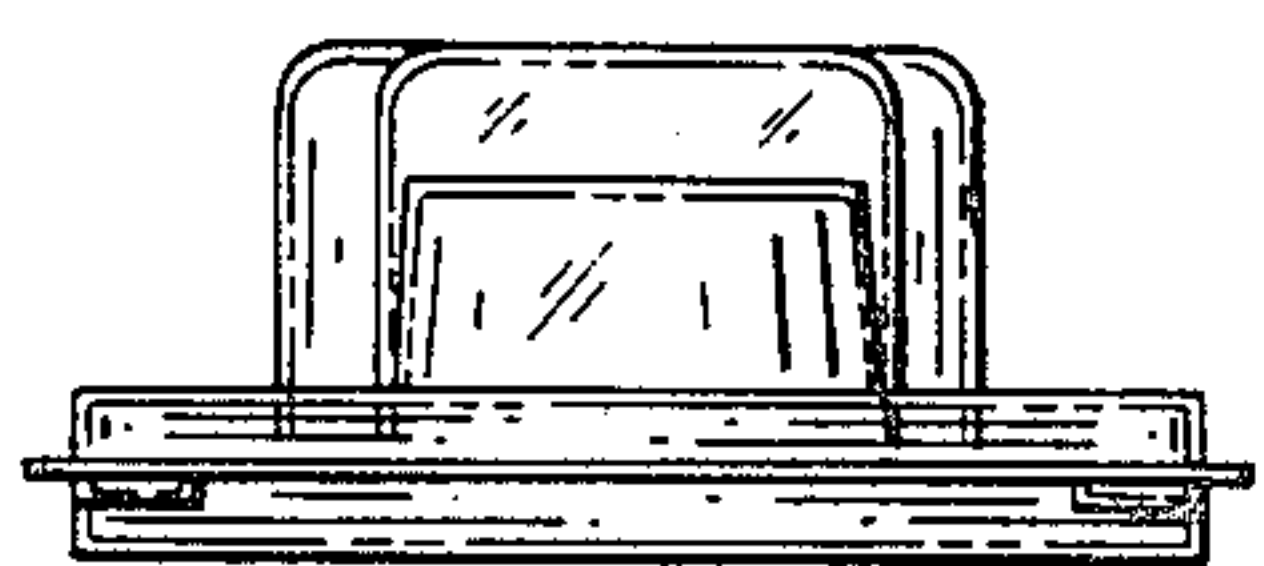

FIG. 3

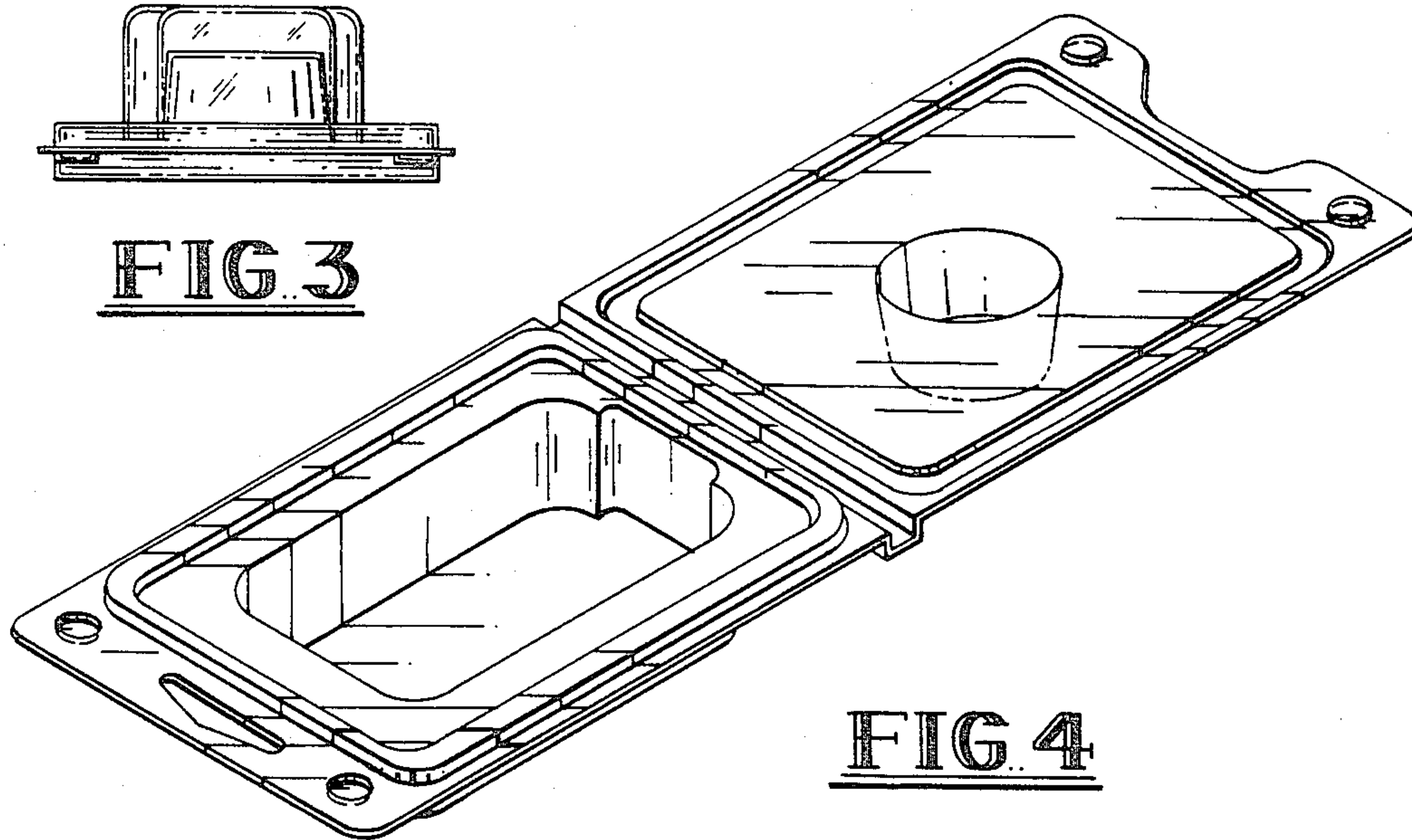

FIG. 4