

[54] CALL PROCESSOR FOR A TELEPHONE SYSTEM

[75] Inventors: Takashi Oshima, Tokyo; Noboru Mihara, Mitaka; Shuji Yamauchi, Higashikurume, all of Japan

[73] Assignee: Iwatsu Electric Co., Ltd., Tokyo, Japan

[\*\*] Term: 14 Years

[21] Appl. No.: 454,454

[22] Filed: Dec. 29, 1982

[30] Foreign Application Priority Data

Jul. 16, 1982 [JP] Japan ..... 57-32243

[52] U.S. Cl. .... D14/58; D14/53; D14/62

[58] Field of Search ..... D14/52-65, D14/106, 113; 179/179, 178, 100 R, 100 C, 100 D, 100 L, 147

[56] References Cited

U.S. PATENT DOCUMENTS

- D. 224,784 9/1972 Sucre et al. .... D14/106
- D. 251,843 5/1979 Knoll et al. .... D14/58
- D. 258,889 4/1981 Hayashi ..... D10/2
- D. 263,824 4/1982 Hagelbarger et al. .... D14/60
- D. 264,826 6/1982 Conforti et al. .... D13/12
- D. 266,512 10/1982 Furbershaw et al. .... D14/58
- D. 269,268 6/1983 Ko ..... D14/58
- 4,291,198 9/1981 Anderson et al. .... 179/2 DP

FOREIGN PATENT DOCUMENTS

2266241 10/1975 France ..... 434/227

OTHER PUBLICATIONS

W. Bello Co. Catalog 1982 ©1981; Showing of "Memory Dialer" by Teleconcepts, p. 238, Item 42310C.  
 Rolm Brochure, Published 4-79; CBX model on Cover, pp. 8,9.  
 Smart Phone—Shown in Telephony, Issue of 2-26-79, p. 45, White by W. Krepick, of Rolm.  
 Markline Catalog—Fall 1982; Handset of "Phone Censor", Item TT267, p. 15.

Primary Examiner—Wallace R. Burke  
 Assistant Examiner—Horace B. Fay  
 Attorney, Agent, or Firm—Oblon, Fisher, Spivak, McClelland & Maier

[57] CLAIM

The ornamental design for a call processor for a telephone system, substantially as shown and described.

DESCRIPTION

FIG. 1 is a top plan view of a call processor for a telephone system, showing our new design;  
 FIG. 2 is a bottom plan view thereof;  
 FIG. 3 is a front elevational view thereof;  
 FIG. 4 is a rear elevational view thereof;  
 FIG. 5 is a side elevational view thereof taken from the right side of FIG. 1;  
 FIG. 6 is a side elevational view thereof taken from the left side of FIG. 1; and  
 FIG. 7 is a perspective view thereof.  
 The showing of a portion of the cord in broken lines in FIGS. 1, 2, 3, 5, 6 and 7 is for facility of illustration.

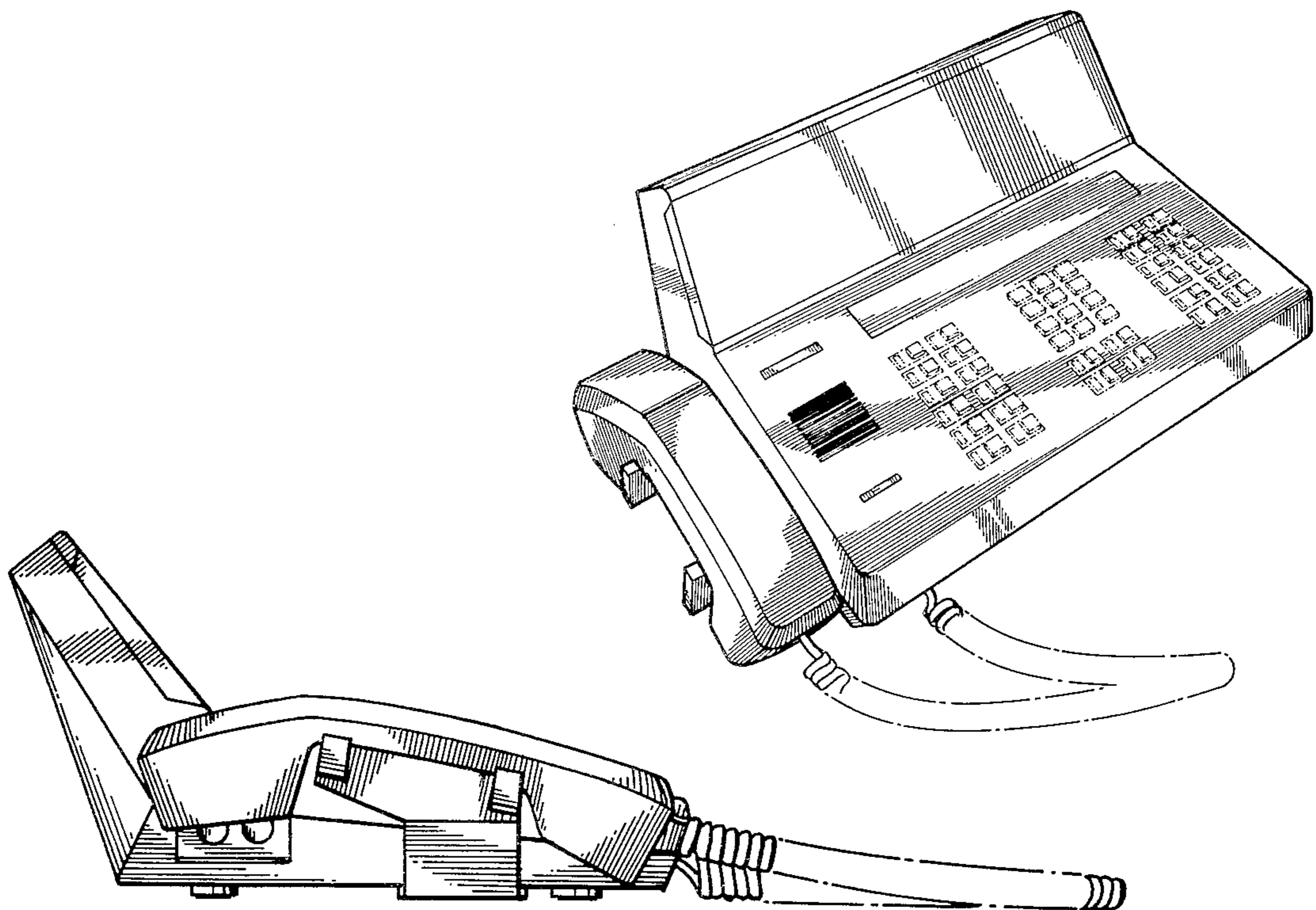

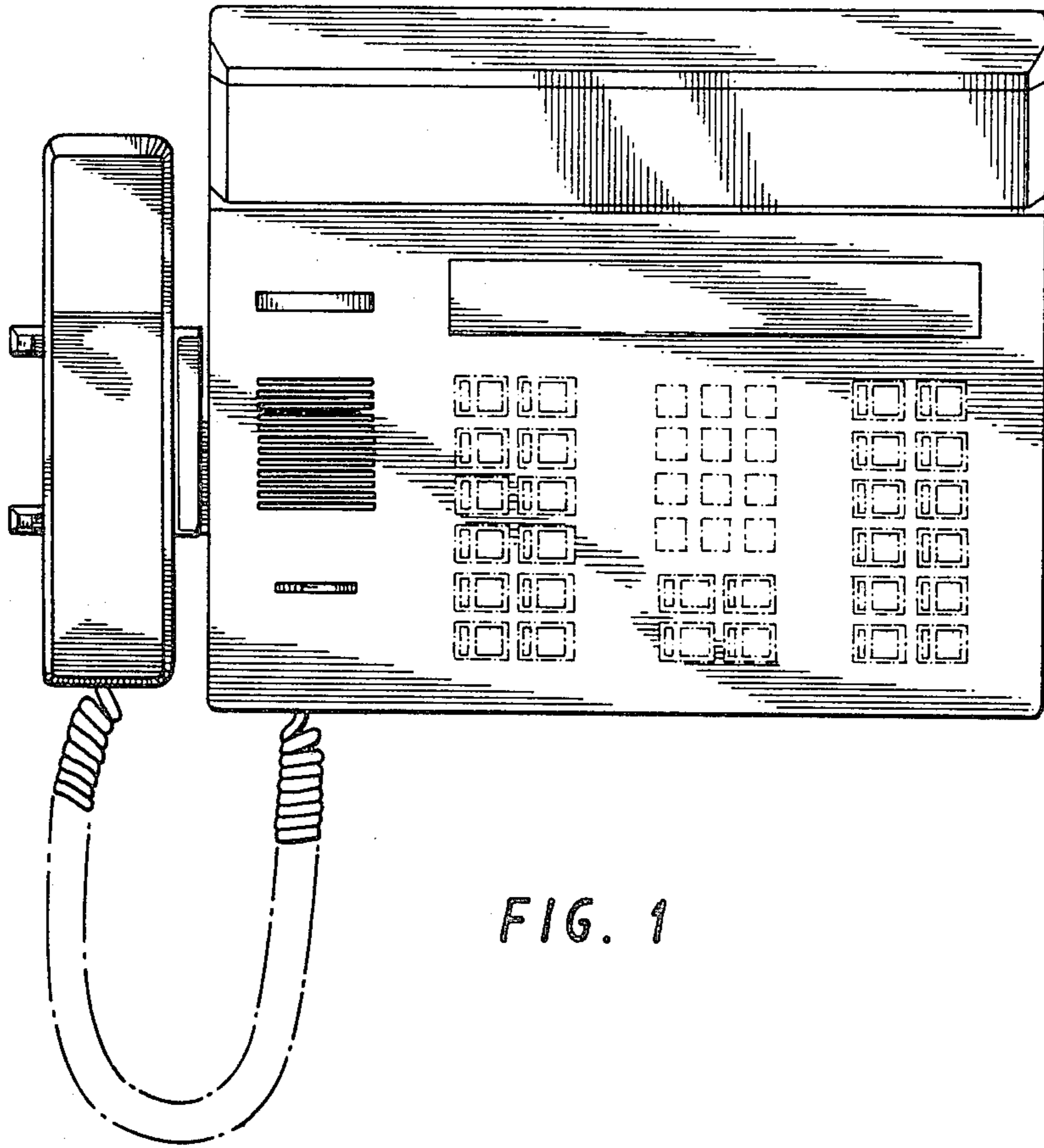

FIG. 1

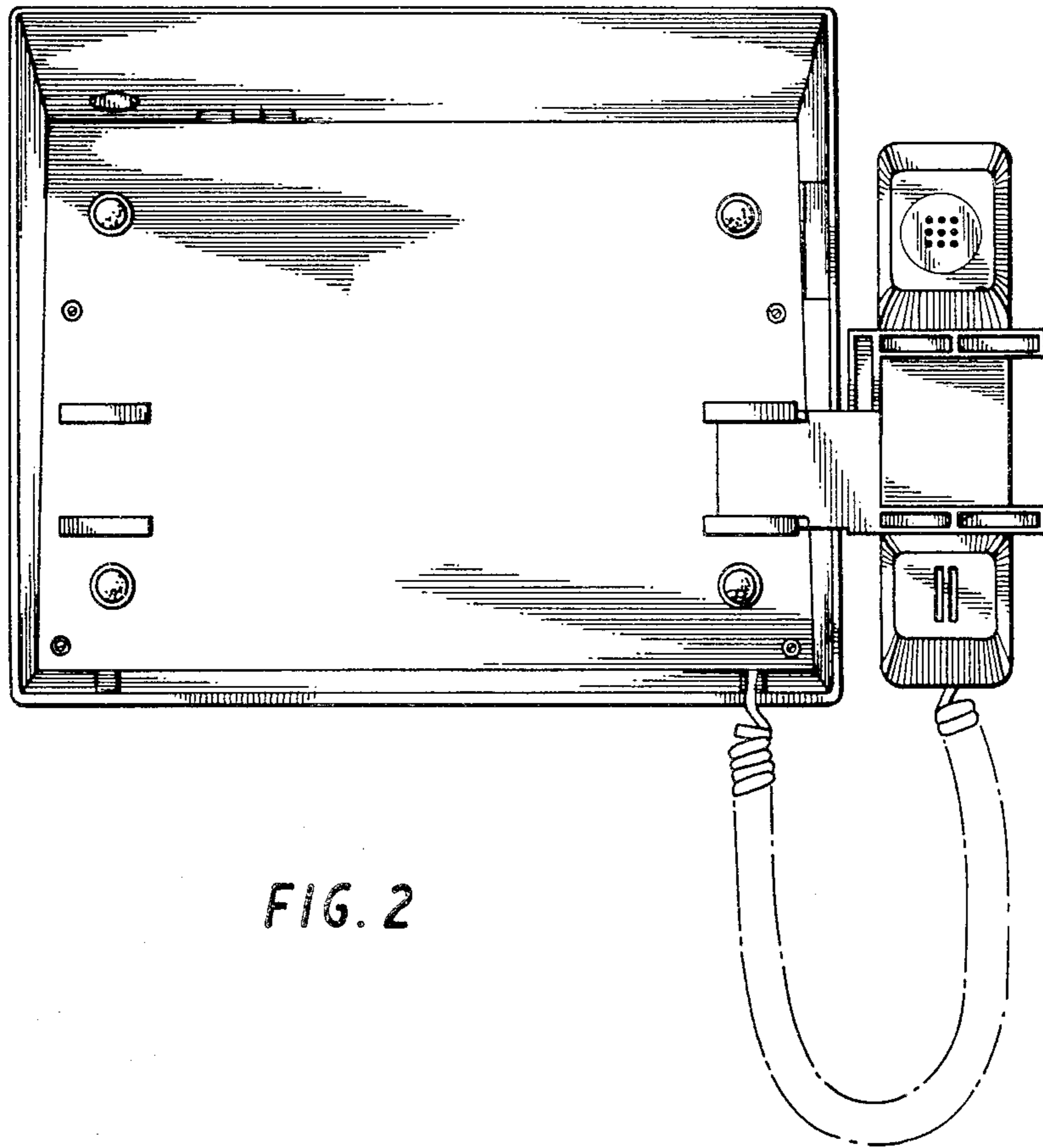

FIG. 2

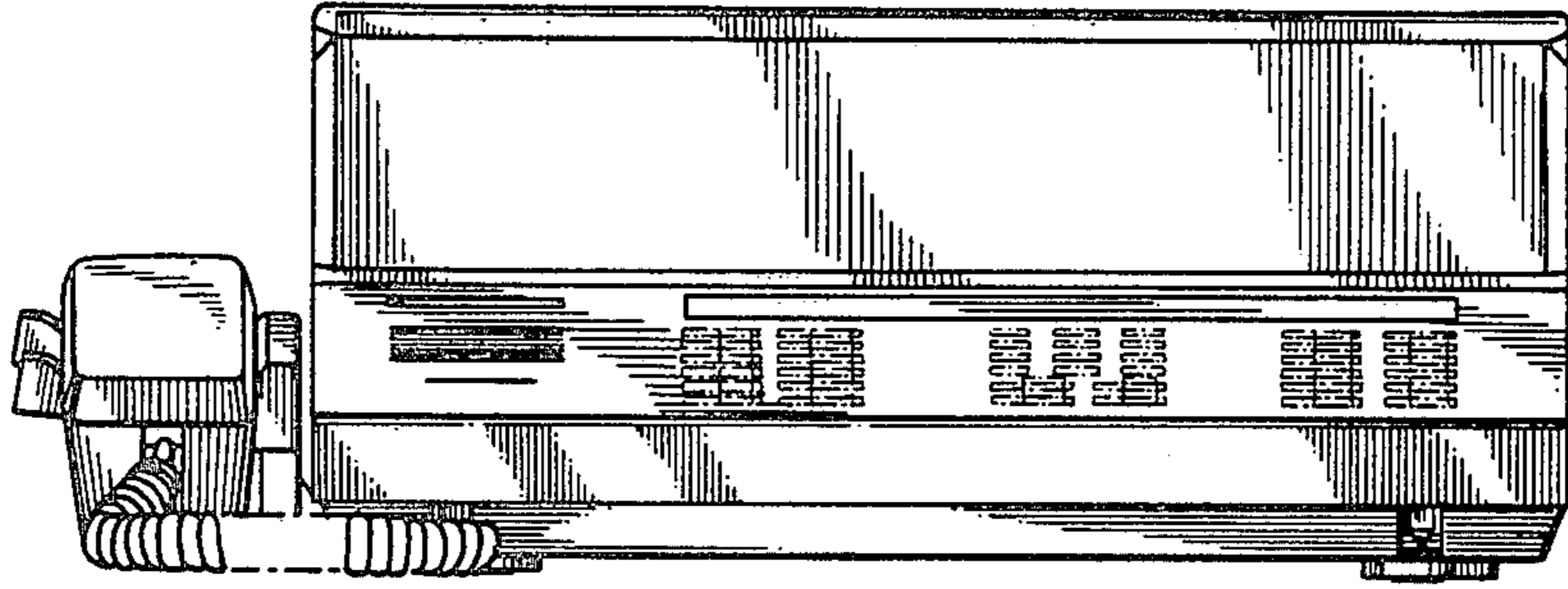

FIG. 3

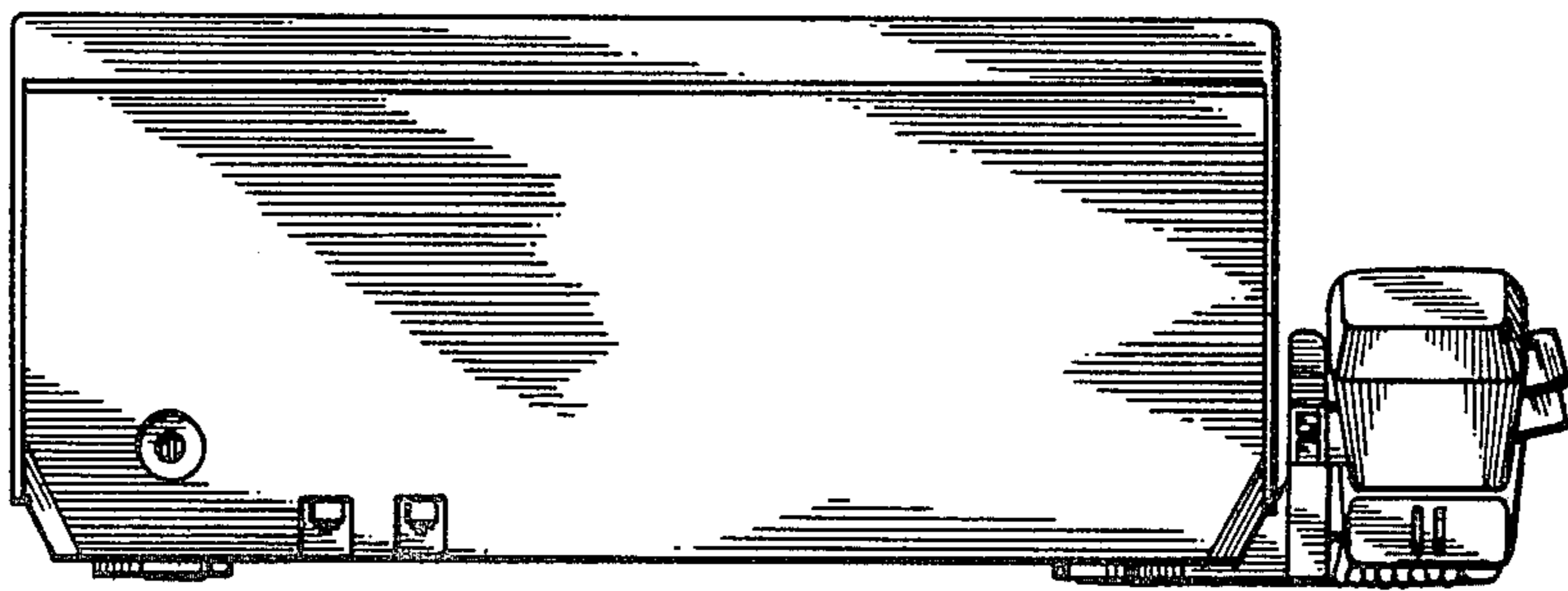

FIG. 4

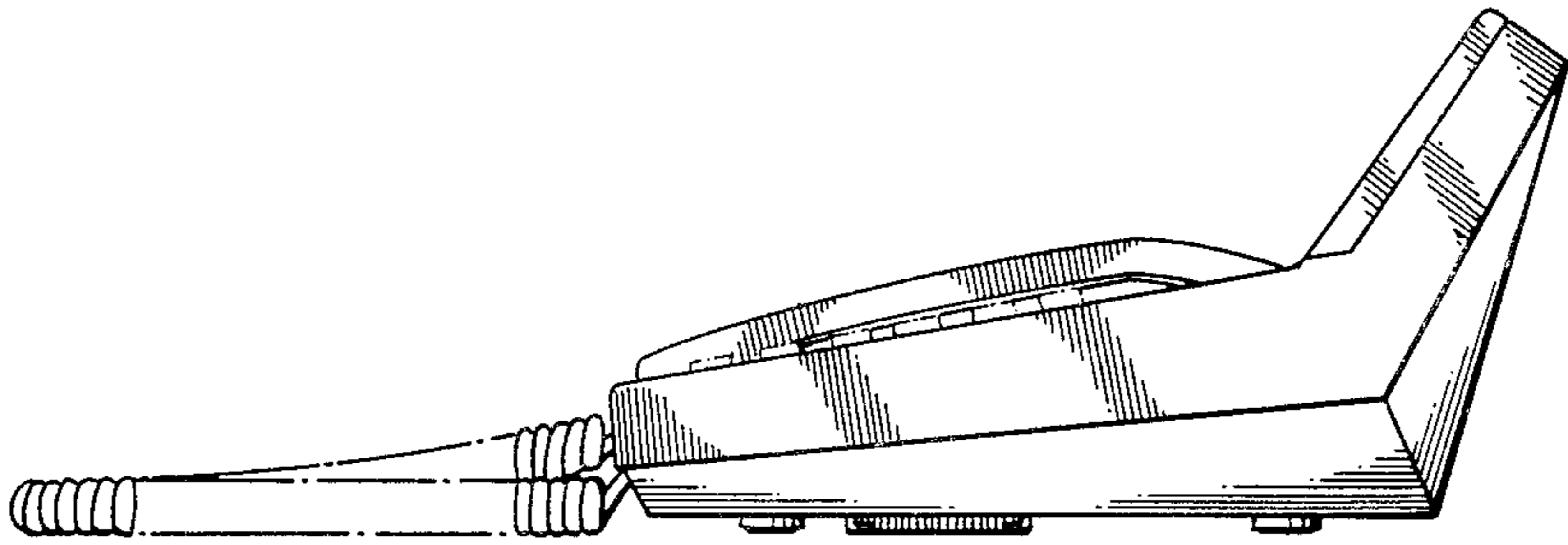

FIG. 5

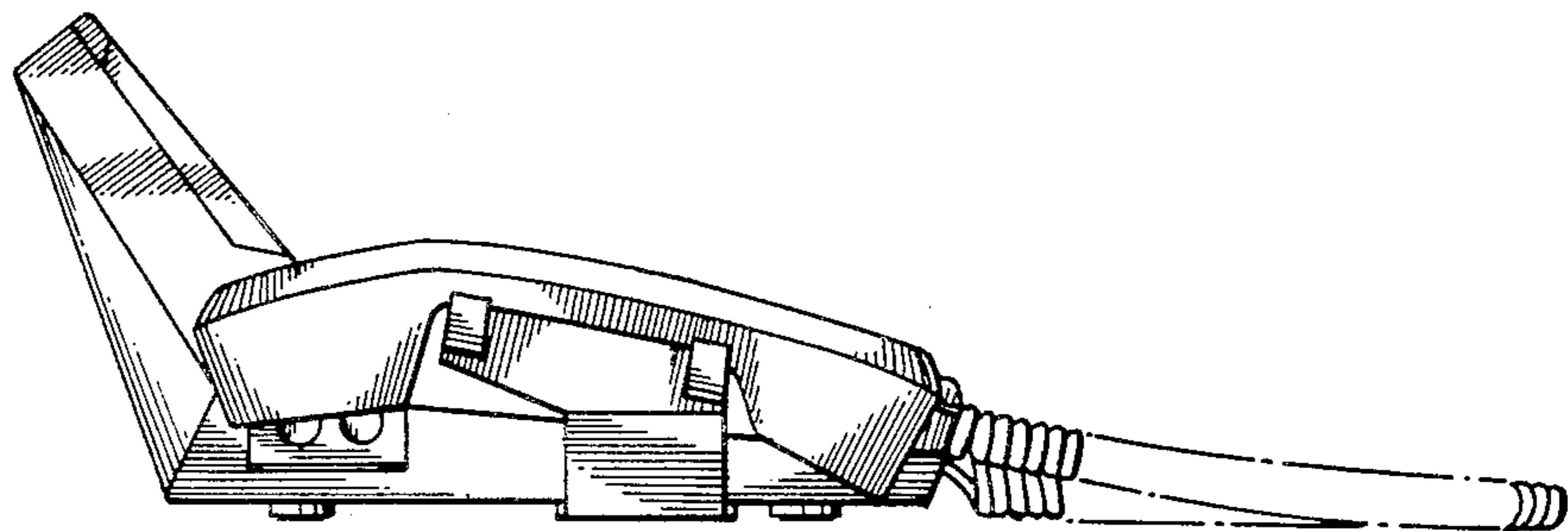

FIG. 6

