

[54] **TERMINAL BLOCK**

[75] Inventor: **Octavio Nüsse**, Münster, Fed. Rep. of Germany

[73] Assignee: **C.A. Weismüller GmbH & Co.**, Detmold, Fed. Rep. of Germany

[**] Term: **14 Years**

[21] Appl. No.: **368,679**

[22] Filed: **Apr. 15, 1982**

[52] U.S. Cl. **D13/24**

[58] Field of Search **D13/24; 339/198 GA**

1065502 9/1959 Fed. Rep. of Germany 339/198 GA

1067097 10/1959 Fed. Rep. of Germany 339/198 GA

1325104 3/1963 France 339/198 GA

340536 10/1959 Switzerland 339/198 GA

Primary Examiner—Susan J. Lucas
Assistant Examiner—C. E. Heflin
Attorney, Agent, or Firm—Michael J. Striker

[57] **CLAIM**

The ornamental design for a terminal block, substantially as shown and described.

DESCRIPTION

FIG. 1 is a perspective view of a terminal block embodying my new design;
 FIG. 2 is a front elevational view thereof;
 FIG. 3 is a rear elevational view thereof;
 FIG. 4 is a side elevational view thereof;
 FIG. 5 is a side elevational view of the side opposite that shown in FIG. 4;
 FIG. 6 is a top plan view thereof; and
 FIG. 7 is a bottom plan view thereof.

[56] **References Cited**

U.S. PATENT DOCUMENTS

2,983,897 5/1961 Blanchet 339/198 GA

3,496,521 2/1970 Hohorst 339/198 GA

FOREIGN PATENT DOCUMENTS

1030419 5/1958 Fed. Rep. of Germany 339/198 GA

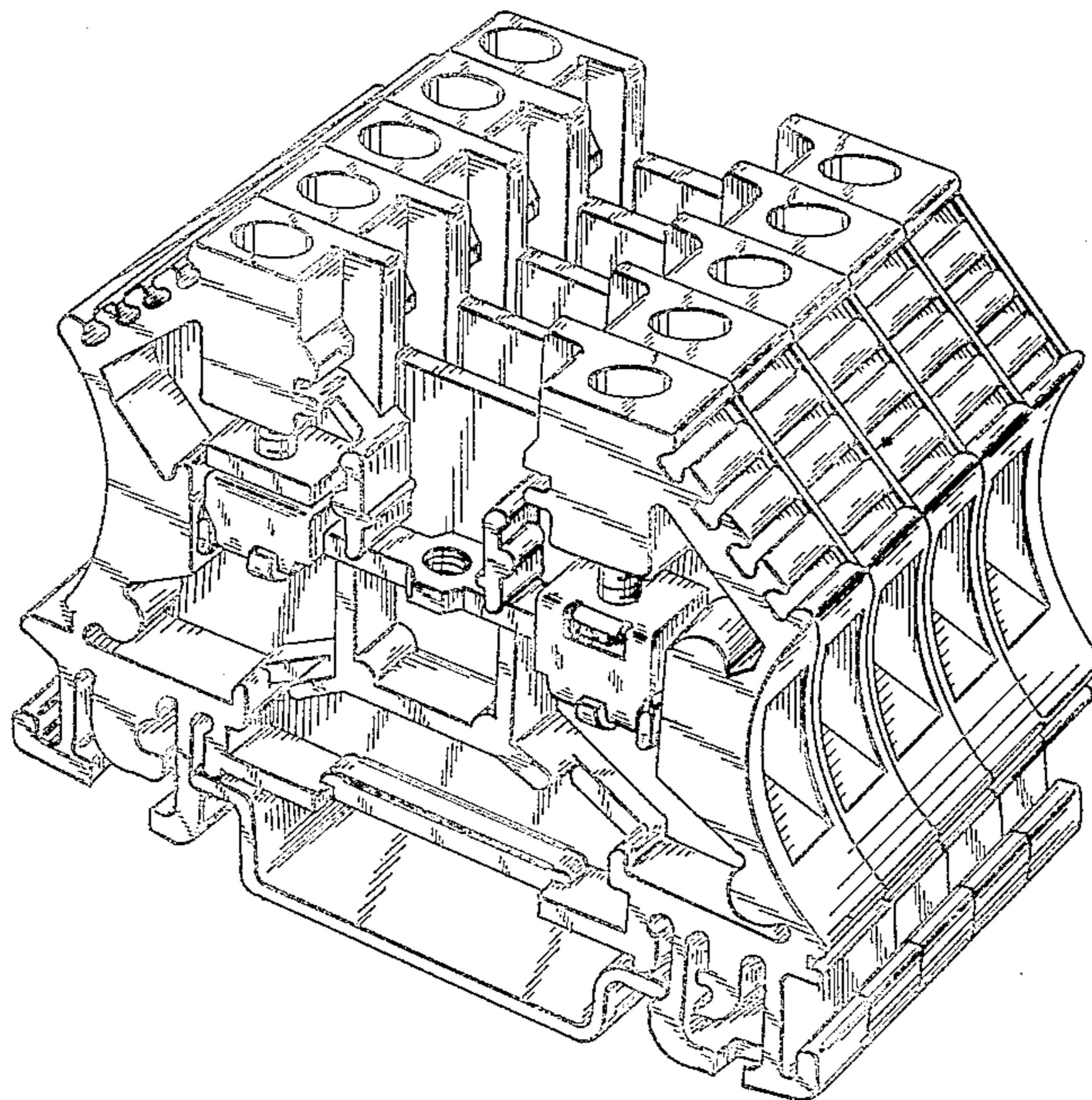

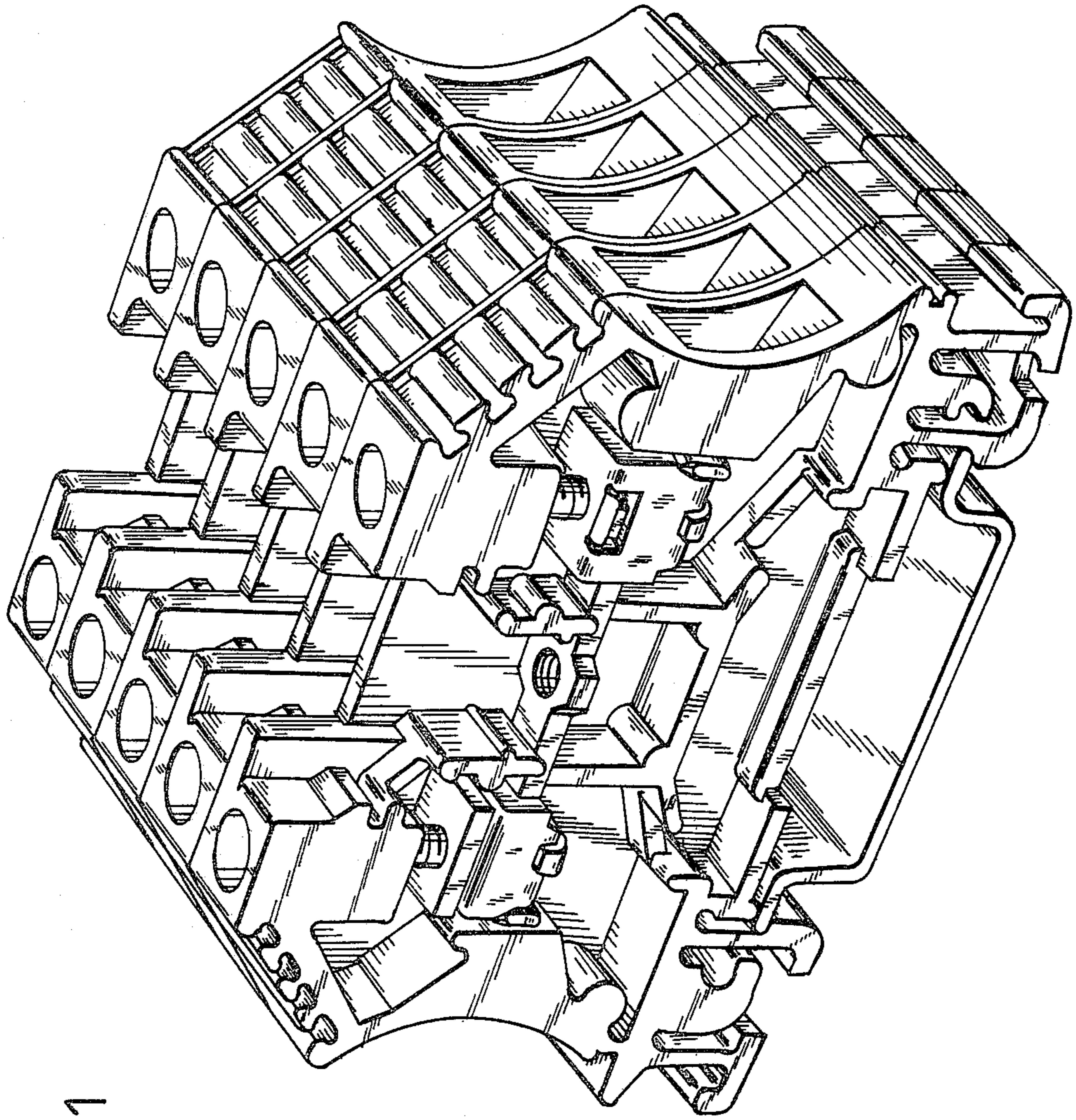

FIG. 1

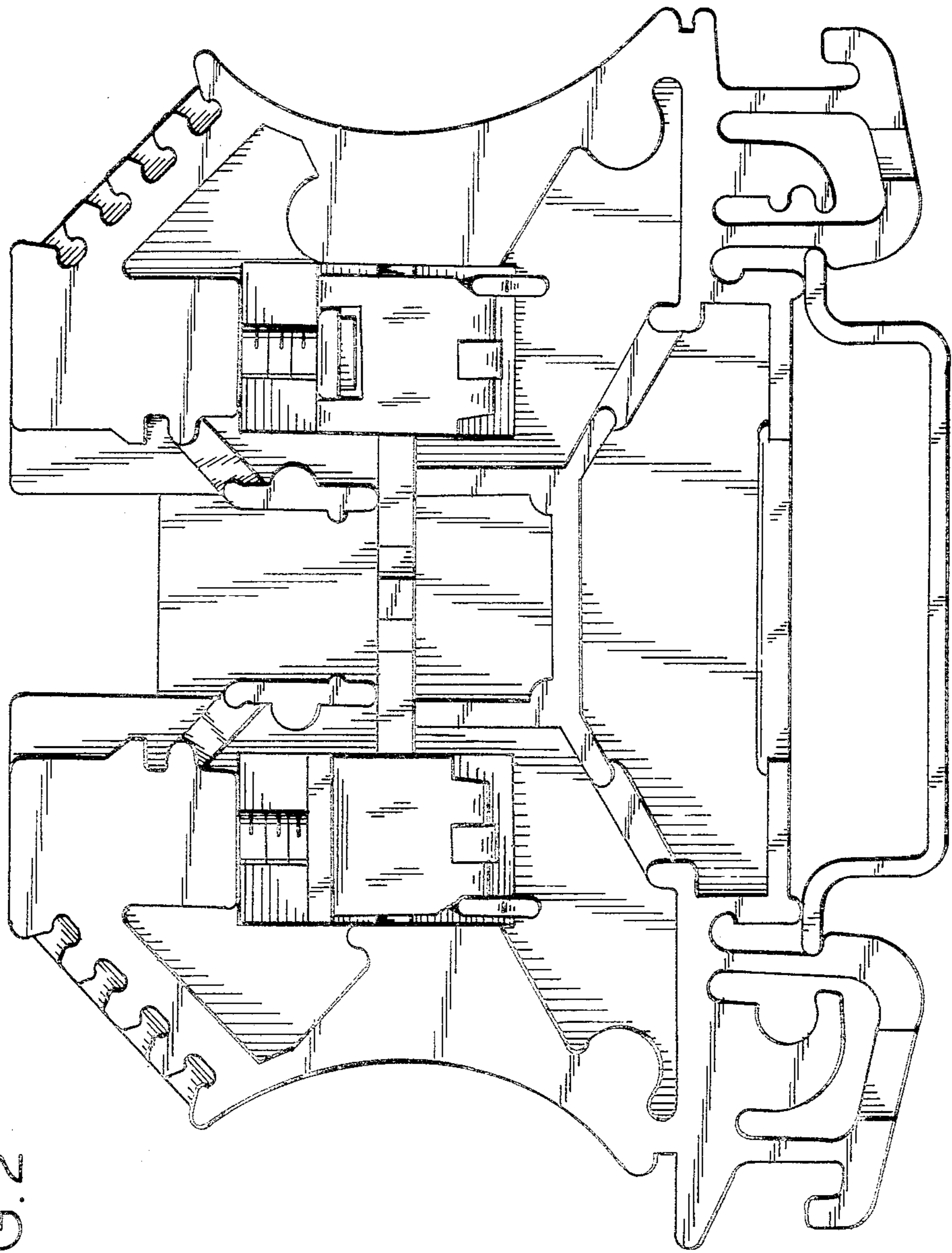
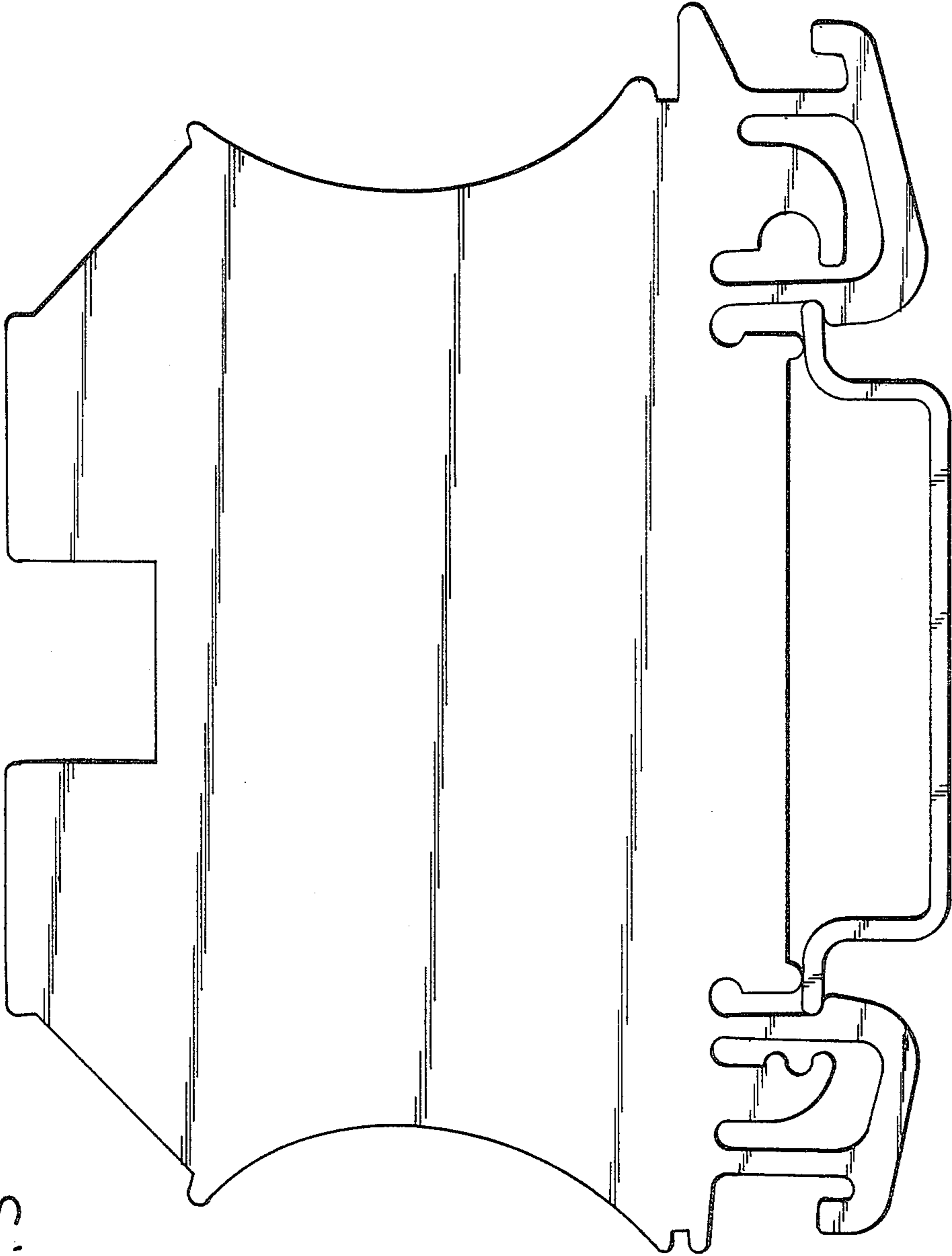

FIG. 2

FIG. 3



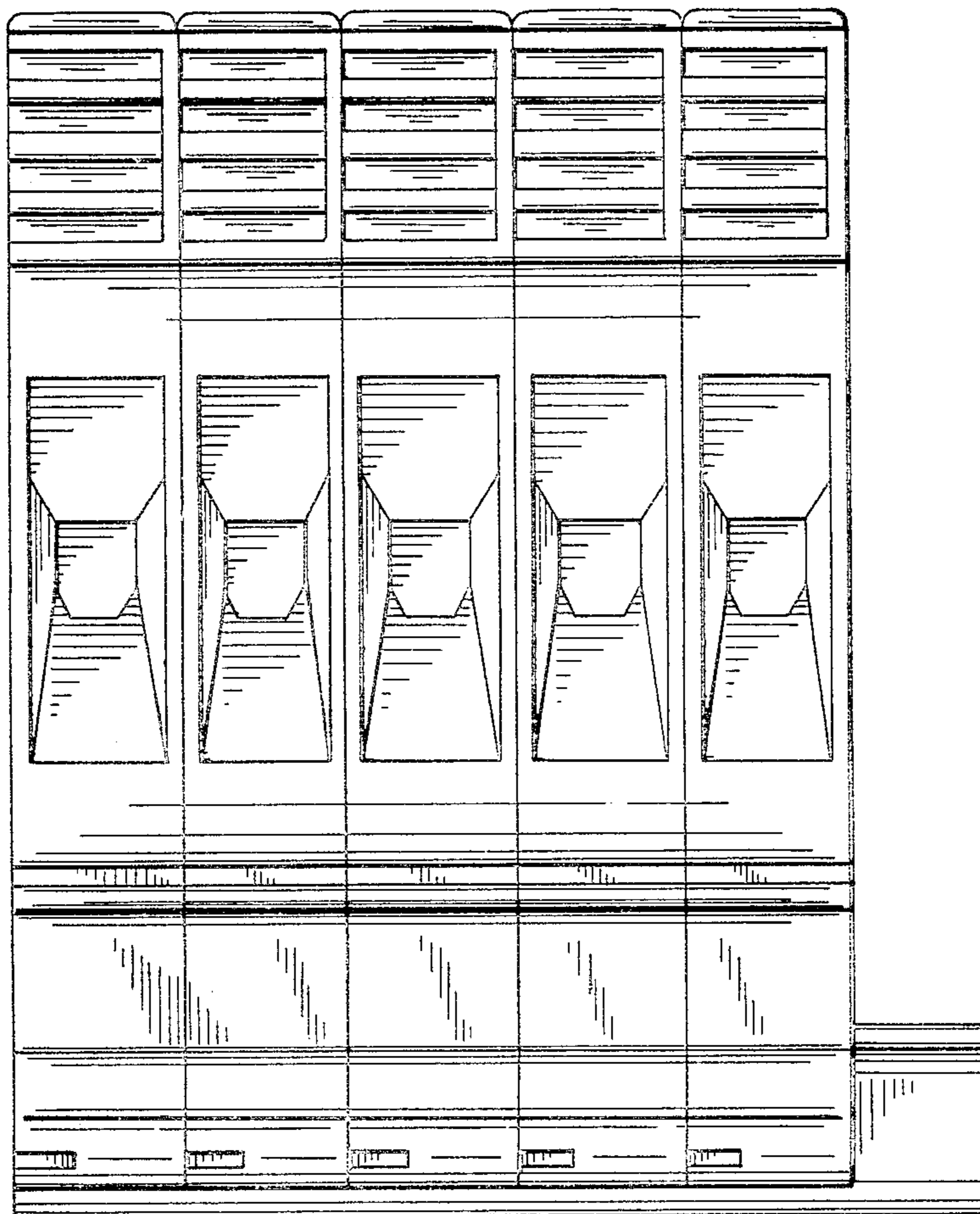

FIG. 4

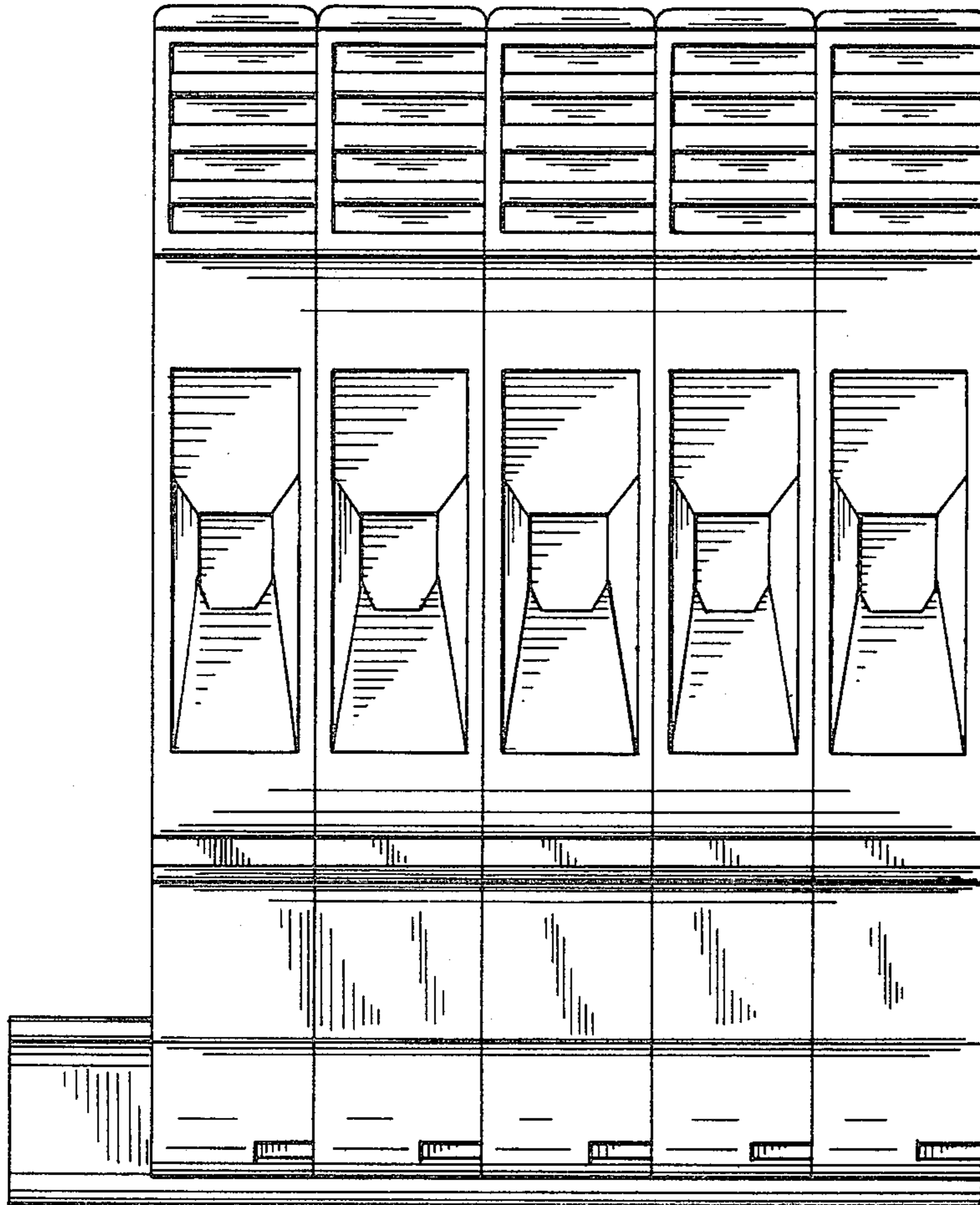

FIG. 5

FIG. 6

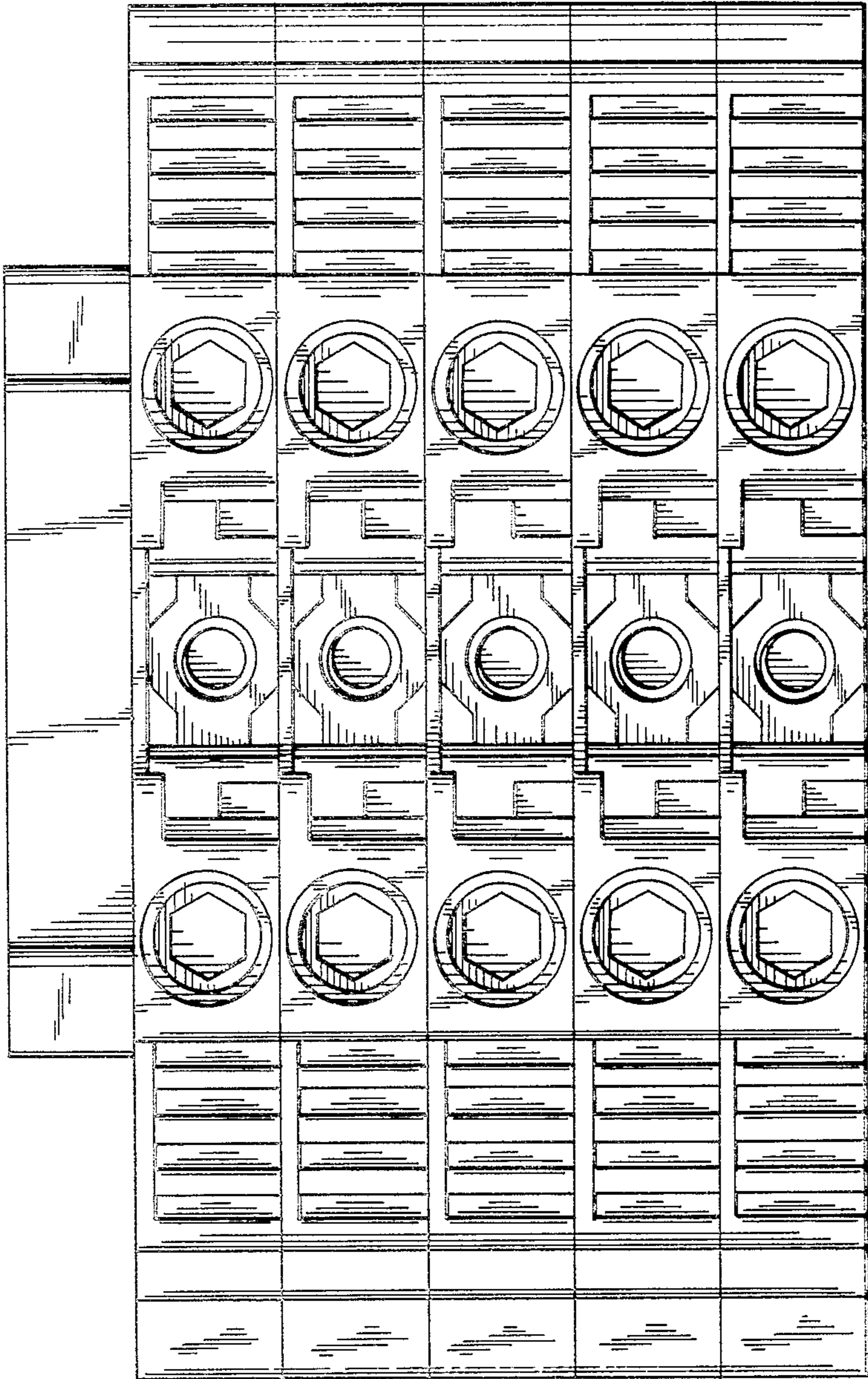
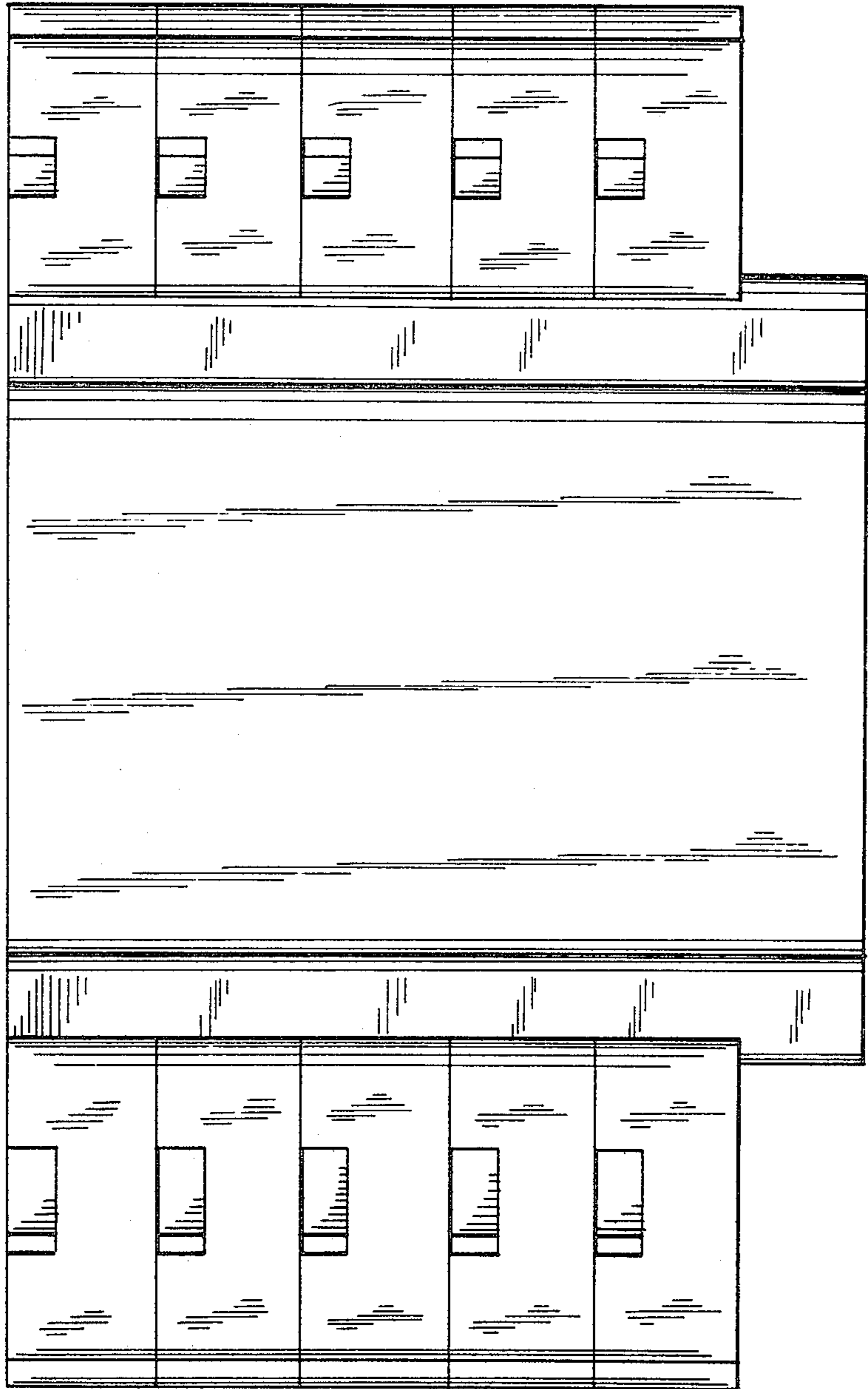

FIG. 7



UNITED STATES PATENT AND TRADEMARK OFFICE
CERTIFICATE OF CORRECTION

PATENT NO. : Design 281 415
DATED : November 19, 1985
INVENTOR(S) : Octavio Nüsse

It is certified that error appears in the above—identified patent and that said Letters Patent is hereby corrected as shown below:

On the title page the correct name of the assignee is
-C.A.Weidmüller GmbH & Co -

Signed and Sealed this
Twenty-third Day of September 1986

[SEAL]

Attest:

DONALD J. QUIGG

Attesting Officer

Commissioner of Patents and Trademarks