

[54] OPENER FOR POP-TOP CONTAINERS

4,253,352 3/1981 O'Neal D8/18

[76] Inventor: James A. Summers, 20730 W. Soledad St., Unit J, Canyon Country, Calif. 91351

Primary Examiner—Bernard Ansher
Assistant Examiner—Terry Pfeffer
Attorney, Agent, or Firm—Christie, Parker & Hale

[**] Term: 14 Years

[57] CLAIM

[21] Appl. No.: 491,530

The ornamental design for opener for pop-top containers, substantially as shown and described.

[22] Filed: May 4, 1983

DESCRIPTION

[52] U.S. Cl. D8/40

[58] Field of Search D8/40, 18, 33, 43; 81/3.46 R, 3.46 A, 3.34, 3.4; 7/151, 152

FIG. 1 is a top perspective view of an opener for pop-top containers showing my new design;

FIG. 2 is a bottom perspective view thereof;

FIG. 3 is a bottom elevation thereof;

FIG. 4 is a top elevation thereof;

FIG. 5 is a side elevation of the view in FIG. 3;

FIG. 6 is an end elevation view of the left side of FIG. 5; and

FIG. 7 is an end elevation from the right side of FIG. 5.

[56] References Cited

U.S. PATENT DOCUMENTS

- D. 269,587 7/1983 Hanslmair D8/40
- D. 274,688 7/1984 Escalante D8/40
- 3,228,552 1/1966 Rutledge 220/284

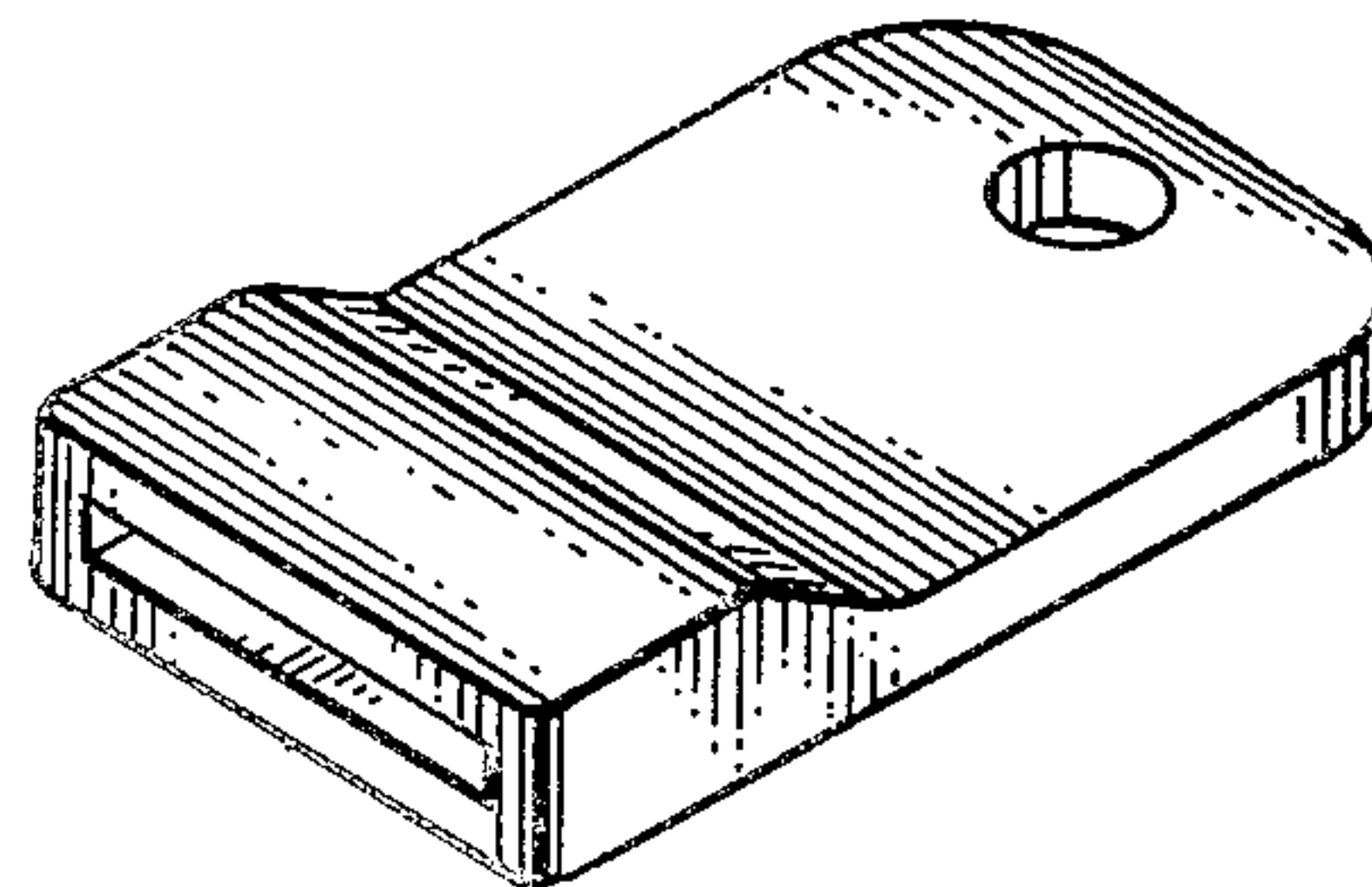
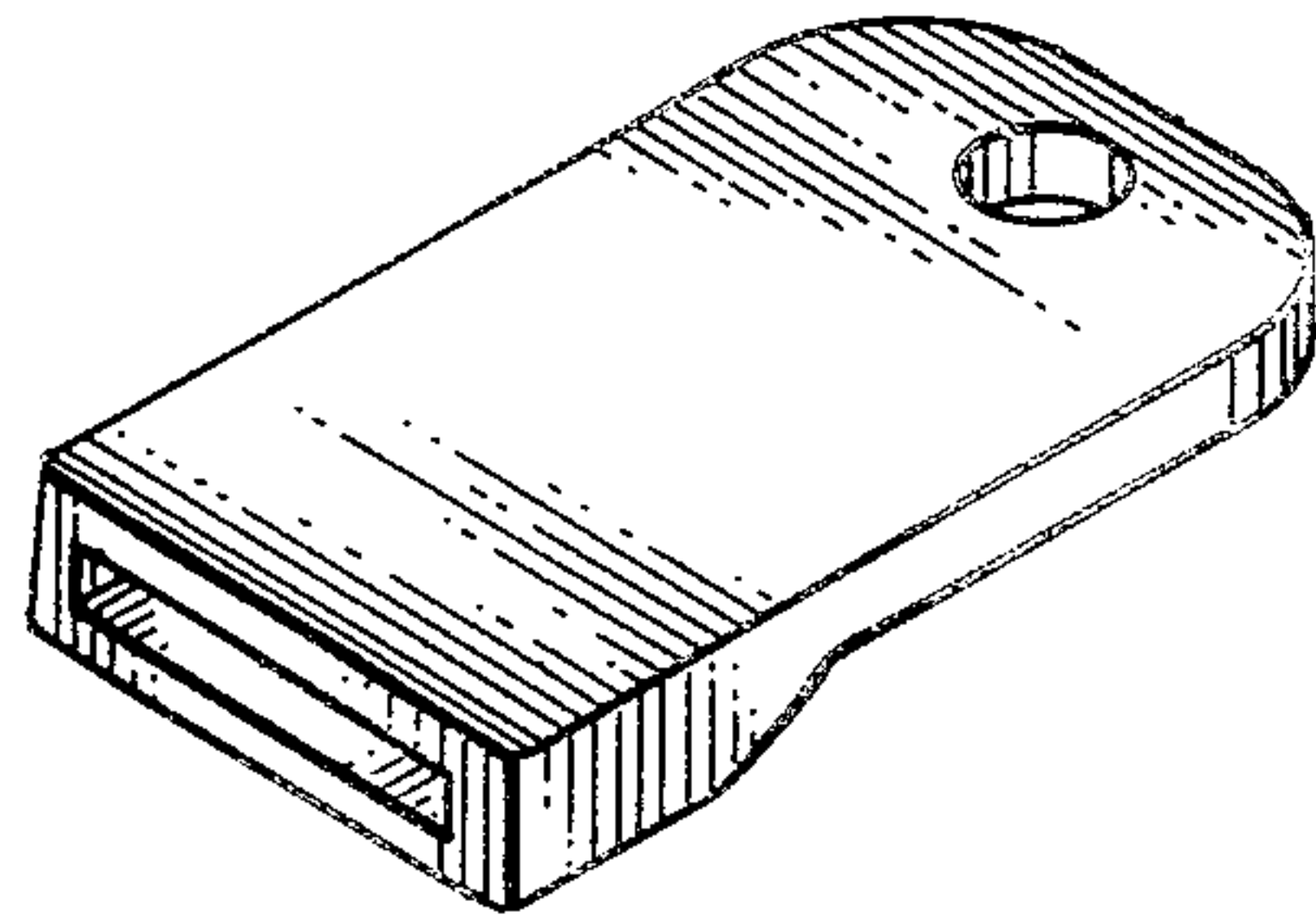

Fig. 1

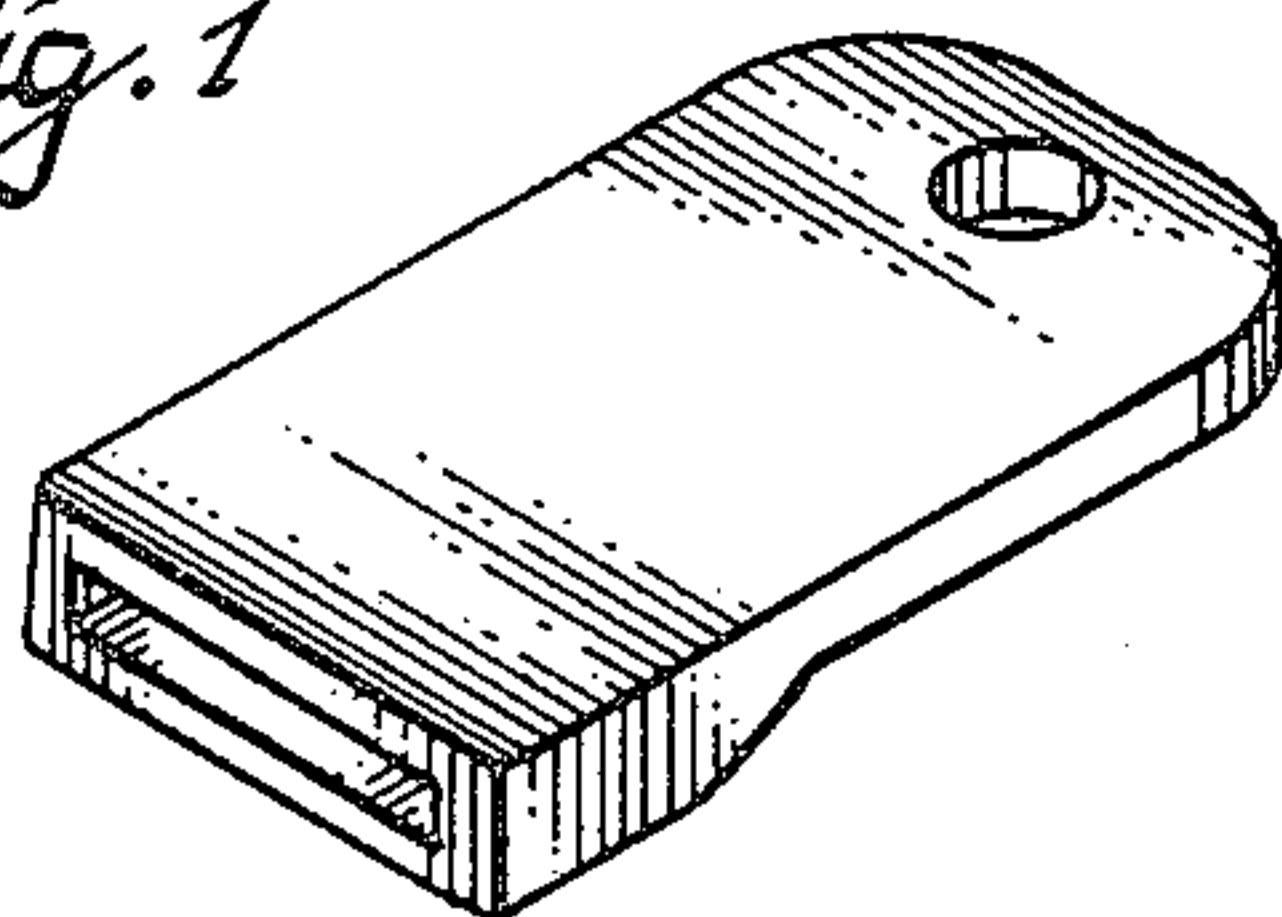

Fig. 2

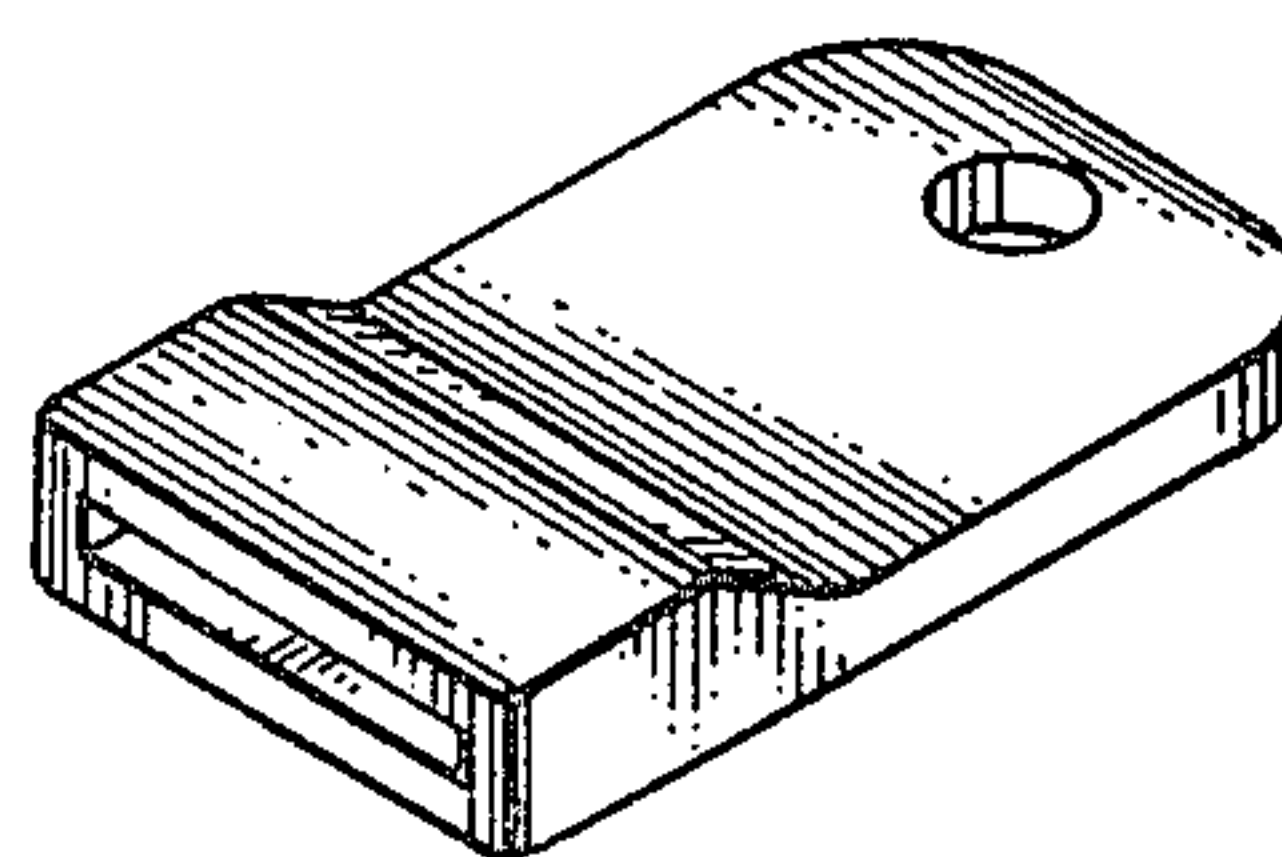

Fig. 3

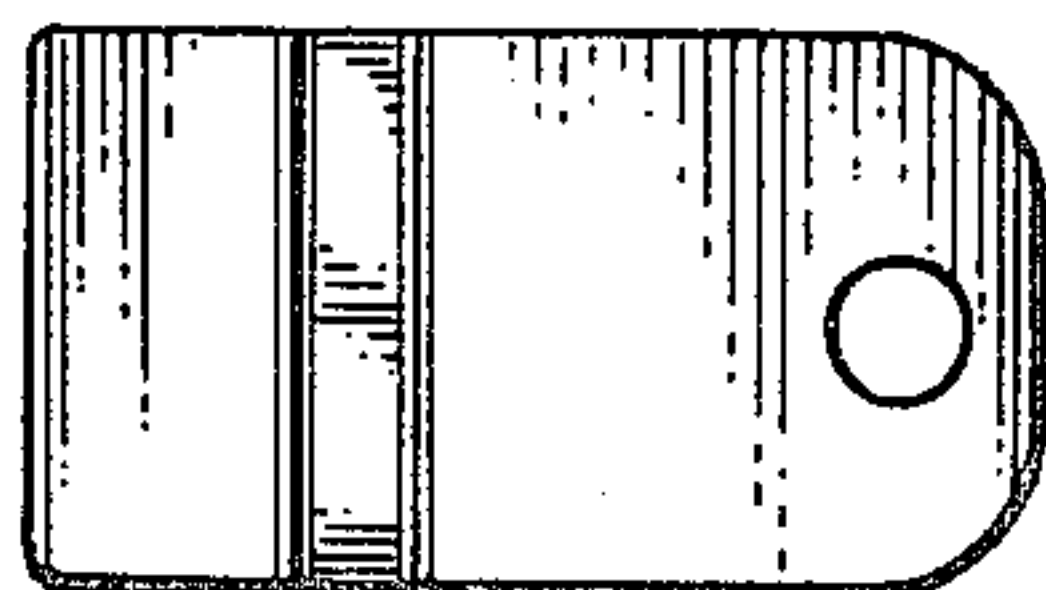

Fig. 4

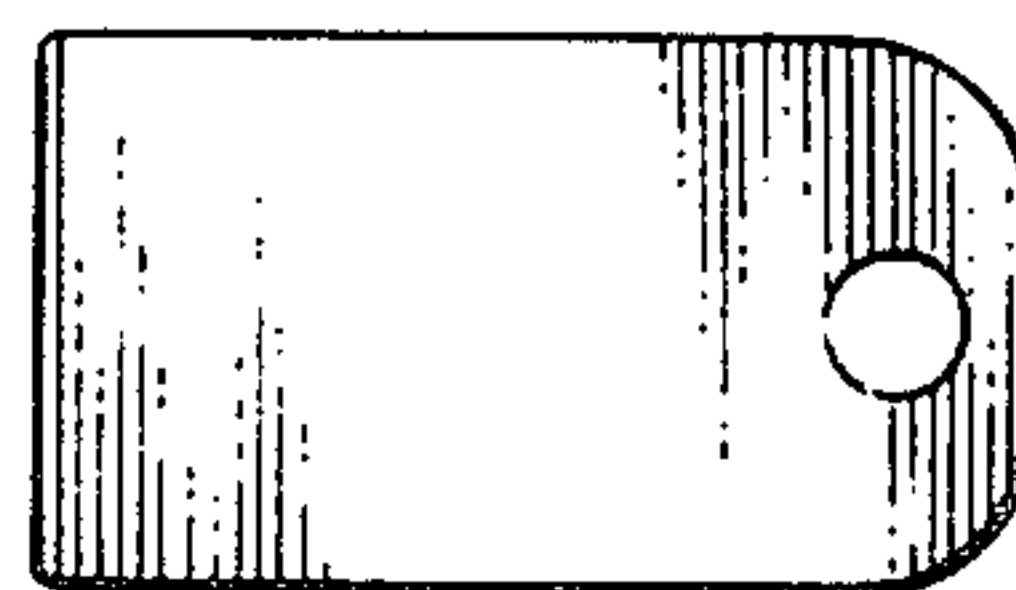

Fig. 5



Fig. 6

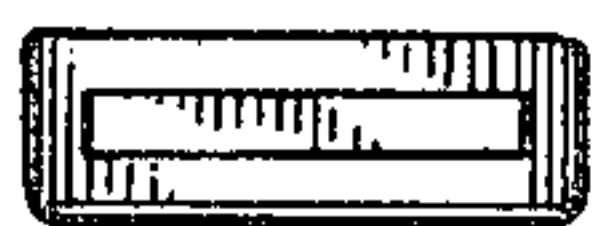

Fig. 7

