

[54] COMPUTER HOUSING

[75] Inventor: Barbara K. Lewis, Sunnyvale, Calif.

[73] Assignee: Qume Corporation, San Jose, Calif.

[\*\*] Term: 14 Years

[21] Appl. No.: 484,137

[22] Filed: Apr. 12, 1983

[52] U.S. Cl. .... D14/100; D13/41; D14/109

[58] Field of Search ..... D14/100, 109; D13/40, D13/41; 360/98, 97, 99

[56] References Cited

U.S. PATENT DOCUMENTS

D. 263,472 3/1982 Nishi et al. .... D14/109

OTHER PUBLICATIONS

Fortune Systems Corp. Brochure ©1982, front cover, Data Processor.

Jade Computer Products Catalog, 1981, p. 4, NEC Microcomputer.

Primary Examiner—Susan J. Lucas

Attorney, Agent, or Firm—T. L. Peterson; J. M. May

[57] CLAIM

The ornamental design for a computer housing, or similar article substantially as shown and described.

DESCRIPTION

FIG. 1 is a front elevational view of a computer housing or similar article showing my new design;

FIG. 2 is a top plan view thereof;

FIG. 3 is a rear elevational view thereof;

FIG. 4 is a bottom plan view thereof;

FIG. 5 is a side elevational view thereof as seen from the left;

FIG. 6 is a side elevational view thereof as seen from the right;

FIG. 7 is a front, right side perspective view thereof on a reduced scale;

FIG. 8 is a front perspective view thereof on the scale of FIG. 7, but set in a vertical orientation. A keyboard and video terminal are shown in phantom lines as exemplary of the preferred environment.

A pair of disk drive front panels have, by means of phantom lines, been shown installed within a corresponding opening in the computer housing; however, it should be understood that said disk drive front panels are not an integral part of said computer housing although they are part of its preferred environment.

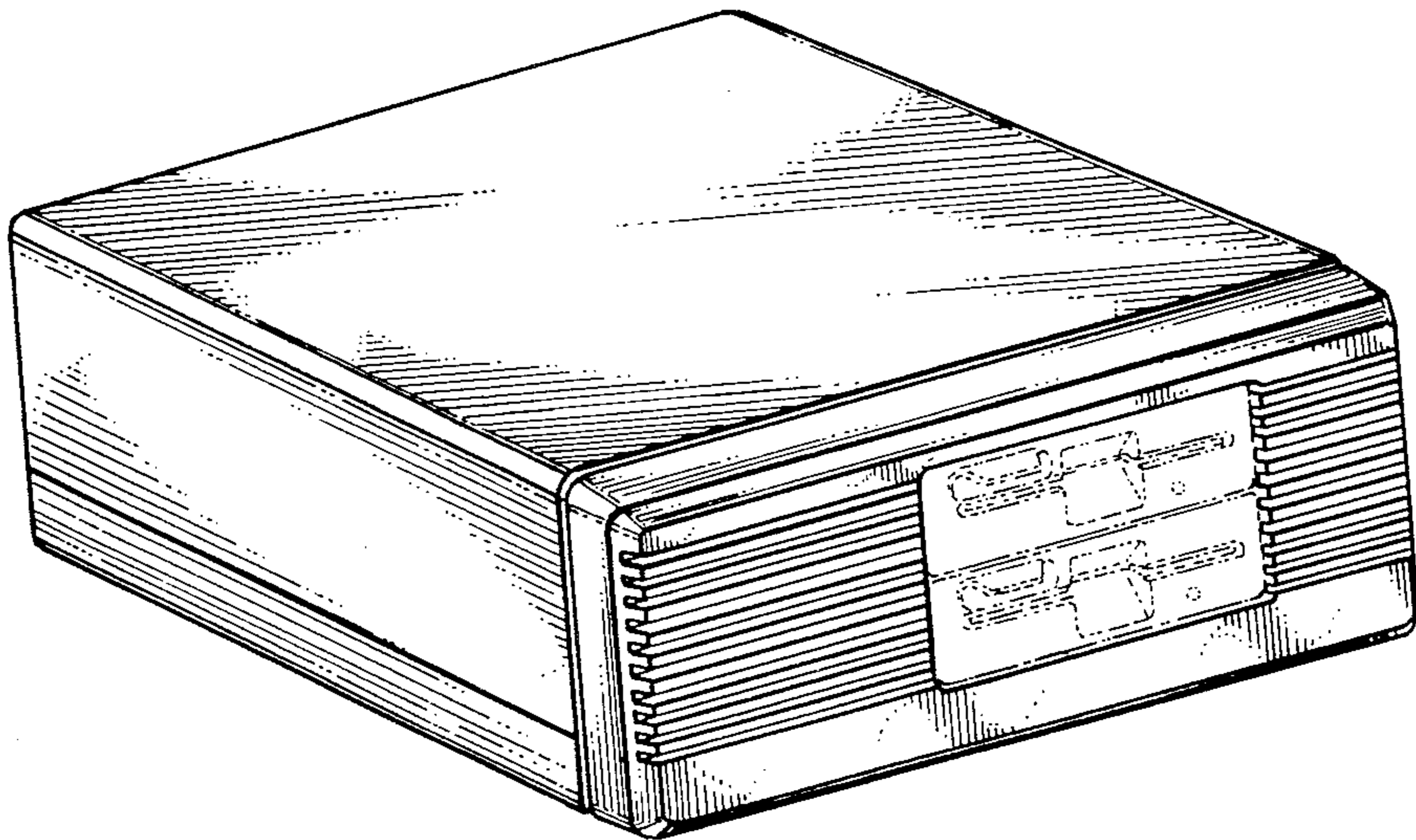

FIG. 1

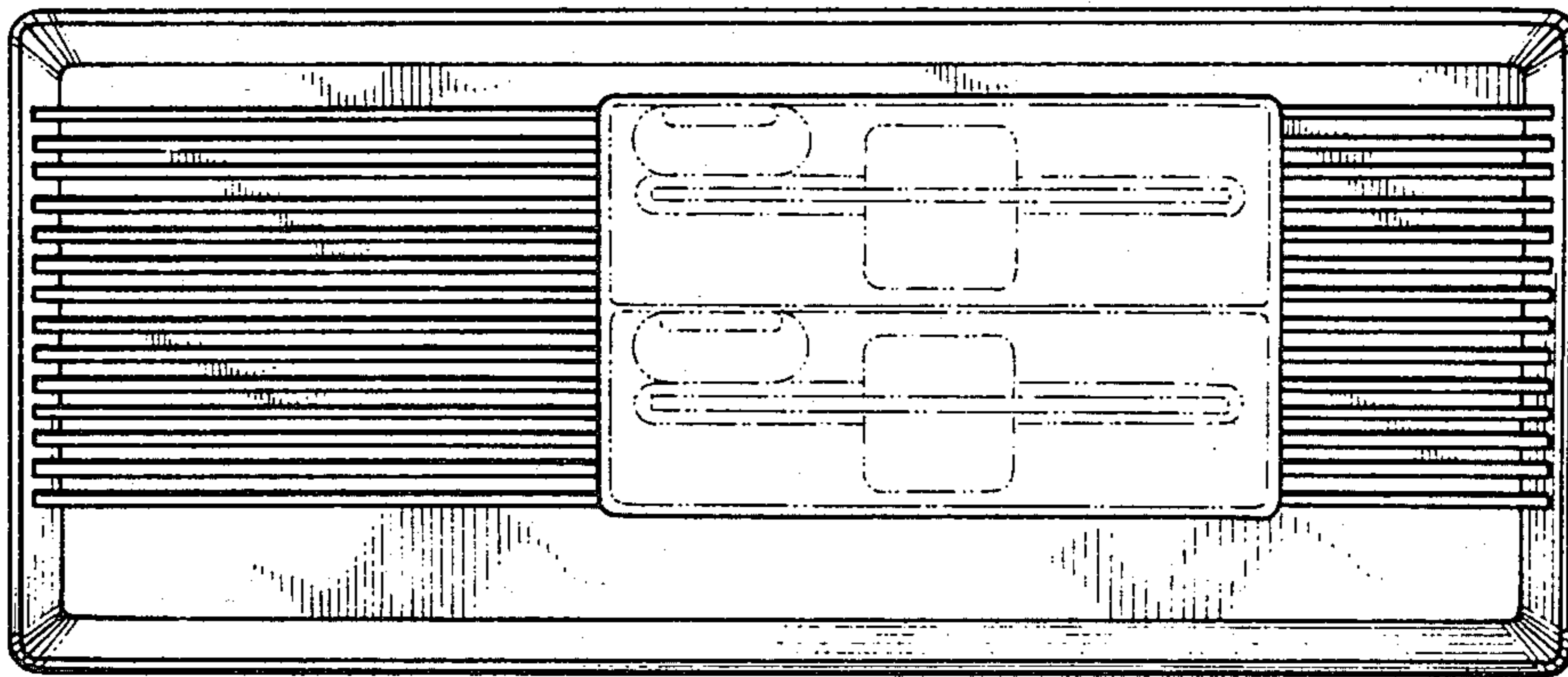

FIG. 2

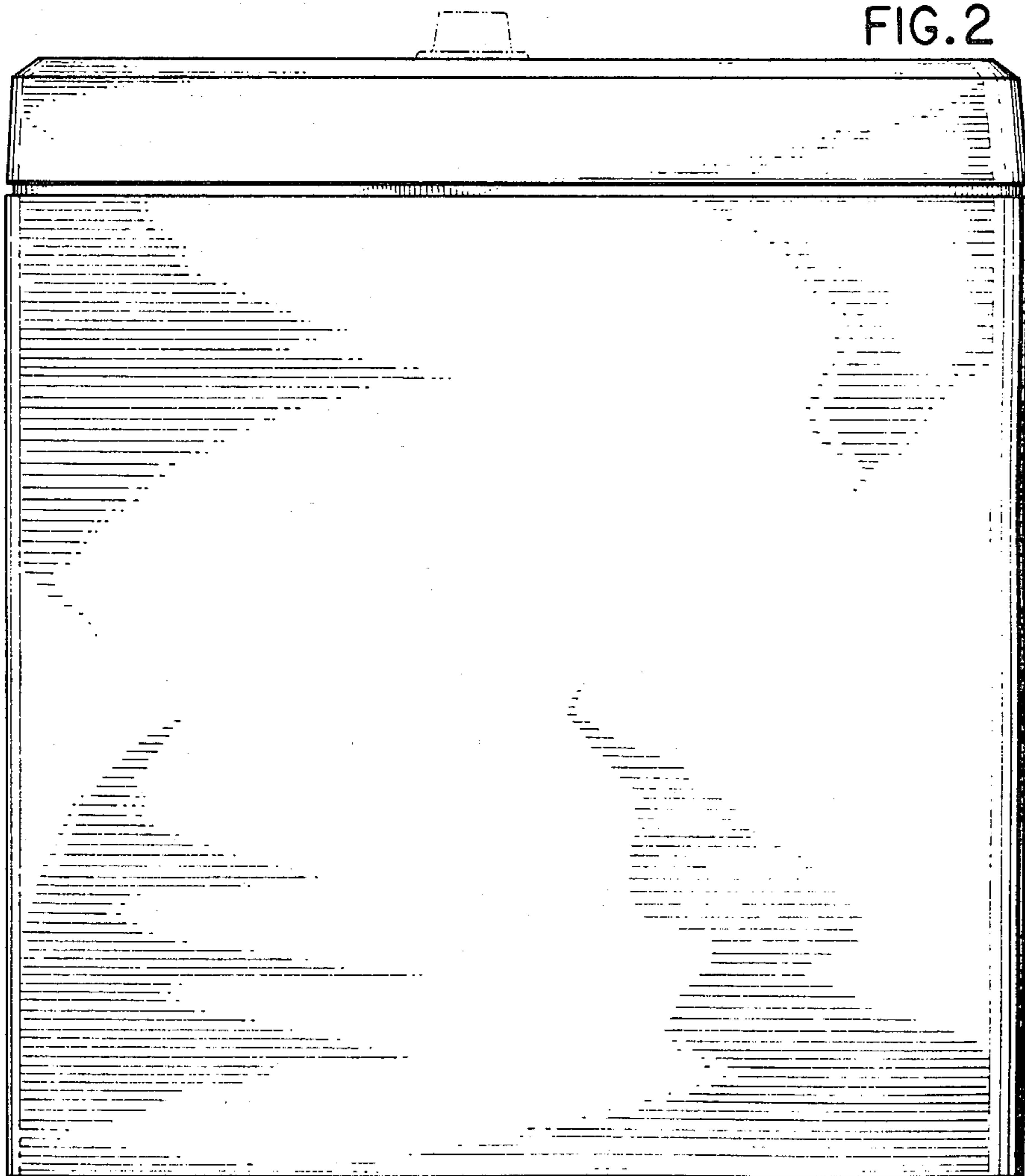

FIG. 3

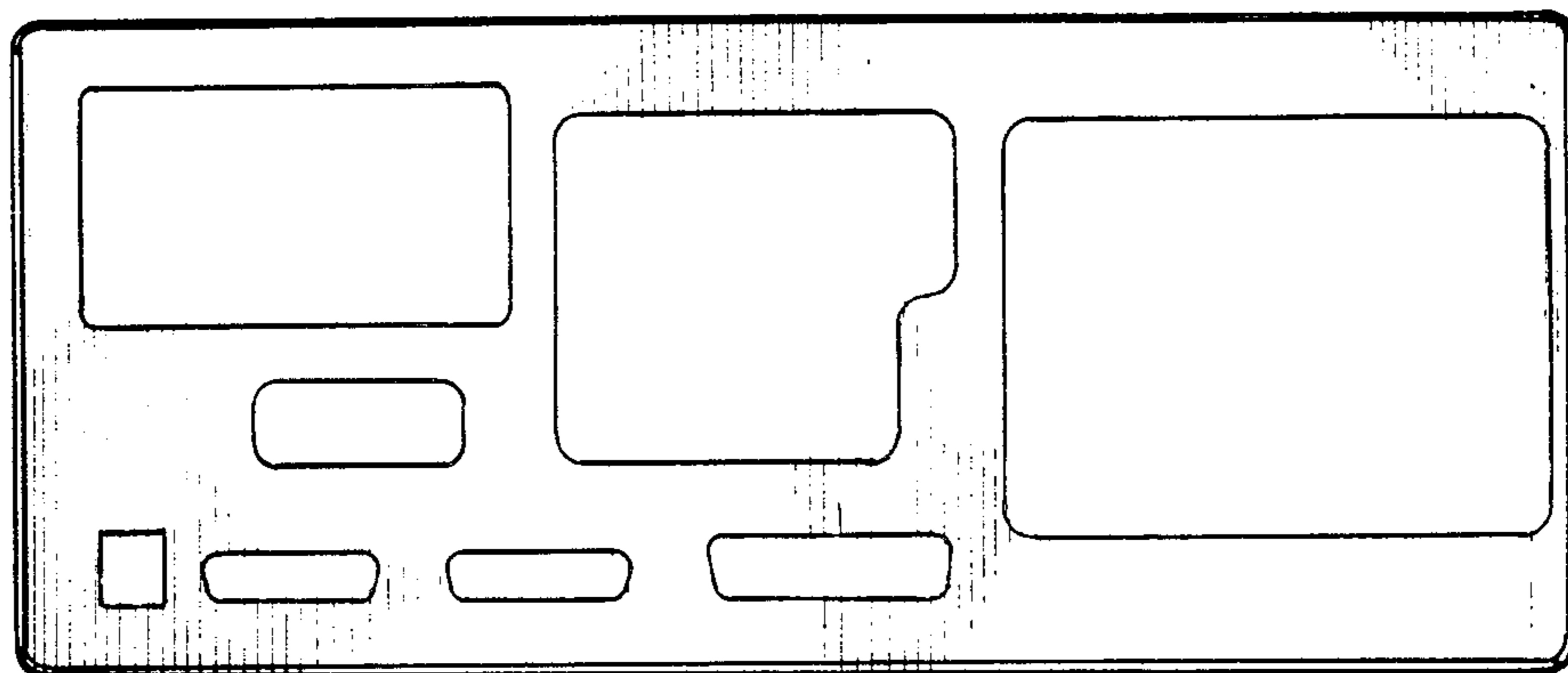
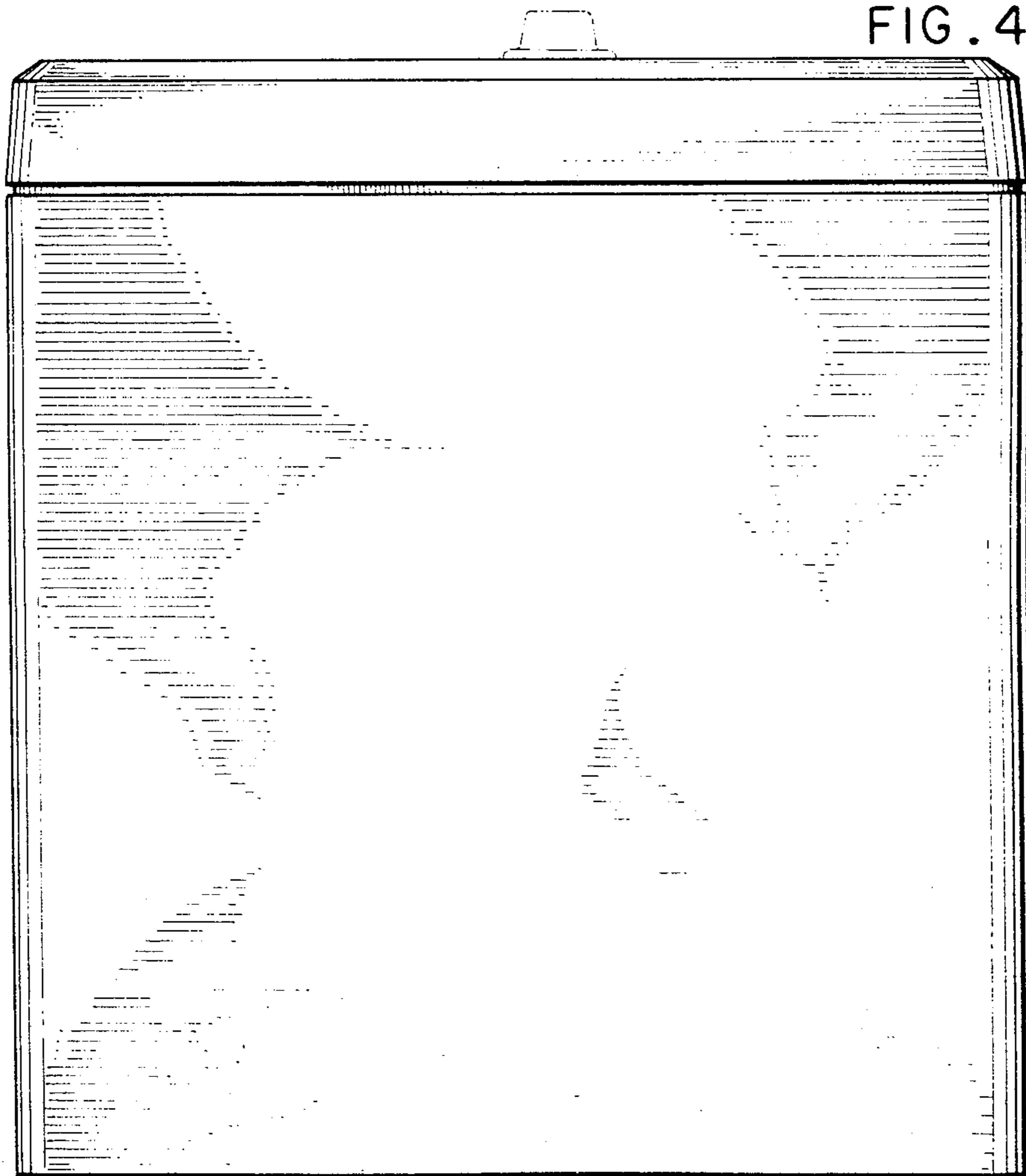

FIG. 4



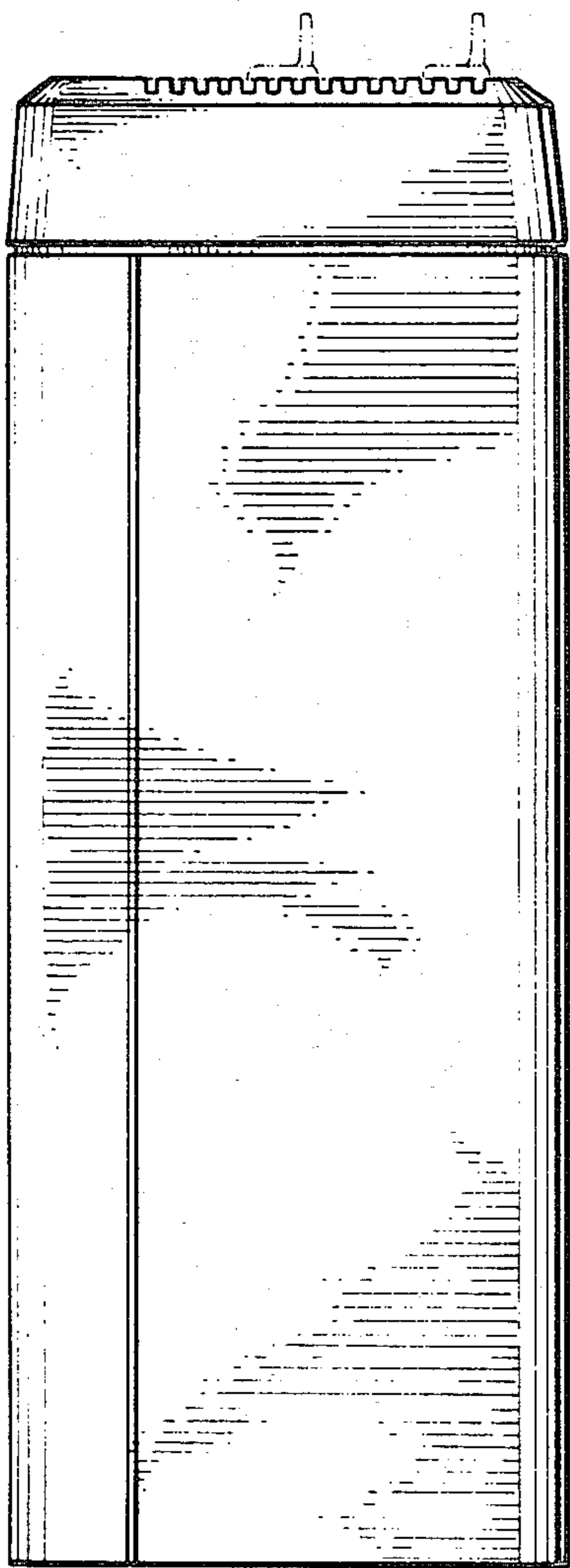

FIG. 5

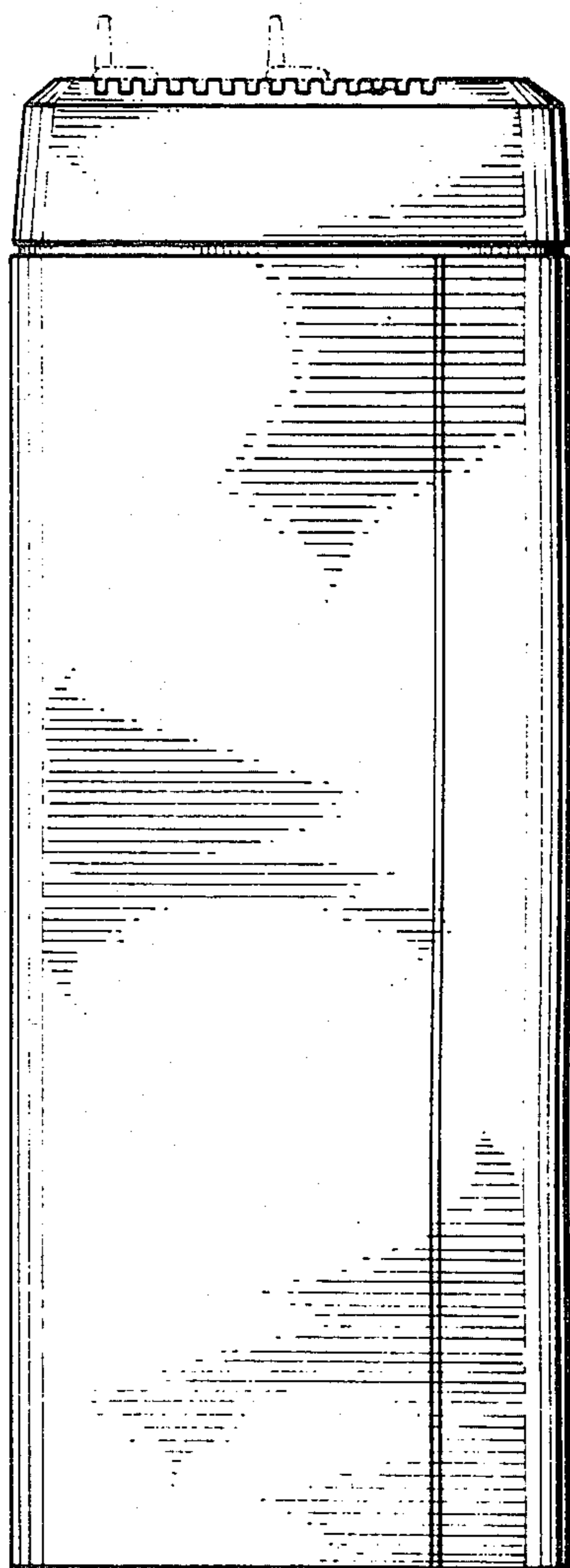

FIG. 6

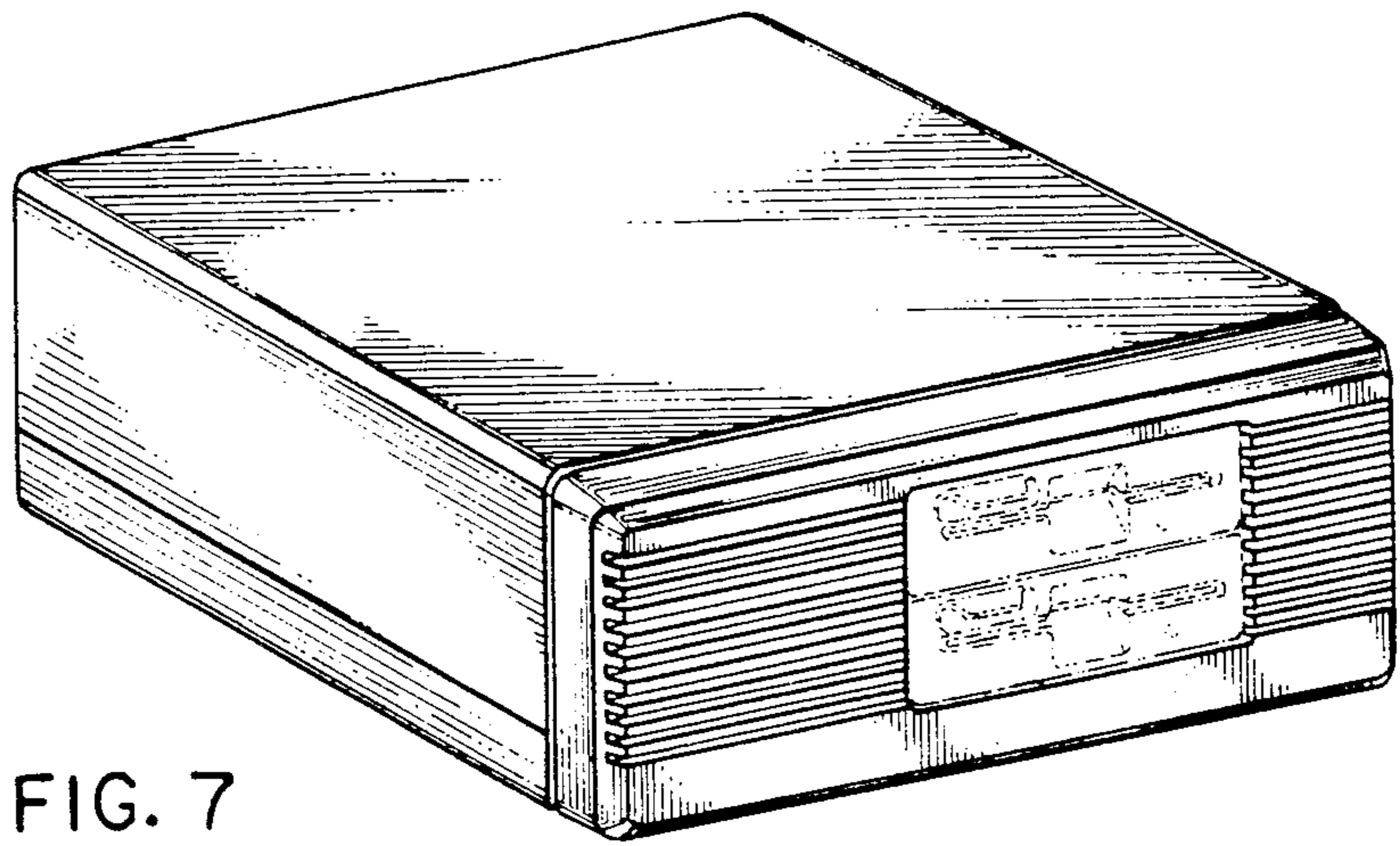

FIG. 7

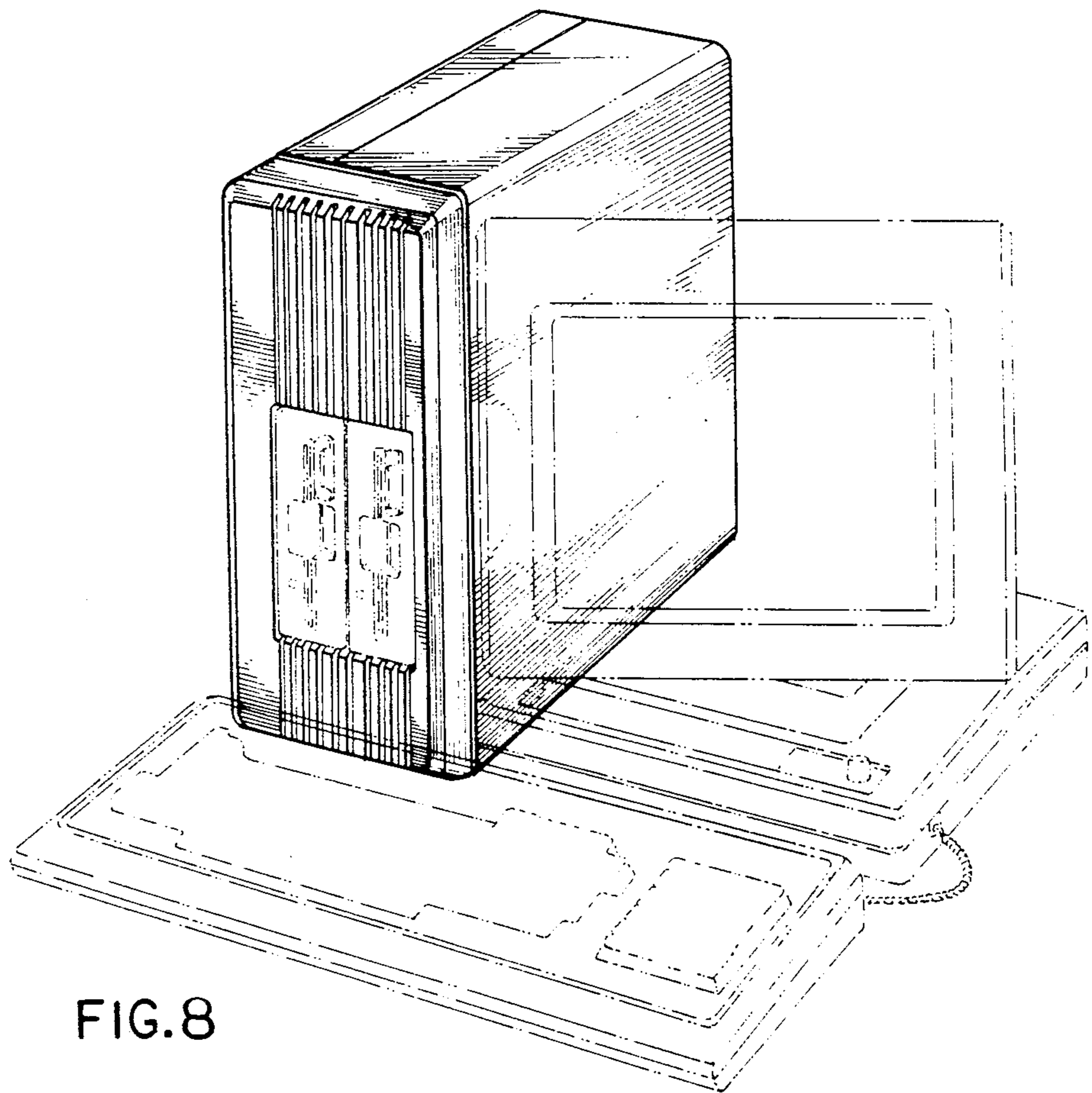

FIG. 8