

[54] PORTABLE TELEVISION SET

[75] Inventor: Yutaka Ohtsu, Yokosuka, Japan

[73] Assignee: Citizen Watch Co., Ltd., Tokyo, Japan

[**] Term: 14 Years

[21] Appl. No.: 534,382

[22] Filed: Sep. 21, 1983

[52] U.S. Cl. D14/77

[58] Field of Search D14/1, 5, 6, 68, 70, D14/77, 80, 81, 84

[56] References Cited

U.S. PATENT DOCUMENTS

- D. 254,737 4/1980 Usami et al. D14/68
- D. 266,665 10/1982 Pulos et al. D14/6
- D. 272,908 3/1984 Matsuo D14/77
- D. 277,099 1/1985 Aoijs D14/70 X

OTHER PUBLICATIONS

Merchandising, 1-83, p. 47, Sony Watchman.

Primary Examiner—Jane E. Corrigan
Attorney, Agent, or Firm—Koda and Androlia

[57] CLAIM

The ornamental design for a portable television set, as substantially shown and described.

DESCRIPTION

FIG. 1 is a top plan view of a portable television set showing my new design;
 FIG. 2 is a front elevational view thereof;
 FIG. 3 is a bottom plan view thereof;
 FIG. 4 is a right side elevational view thereof;
 FIG. 5 is a rear elevational view thereof;
 FIG. 6 is a sectional view taken along line VI—VI in FIG. 2;
 FIG. 7 is a left side elevational view thereof; and
 FIG. 8 is a perspective view thereof.

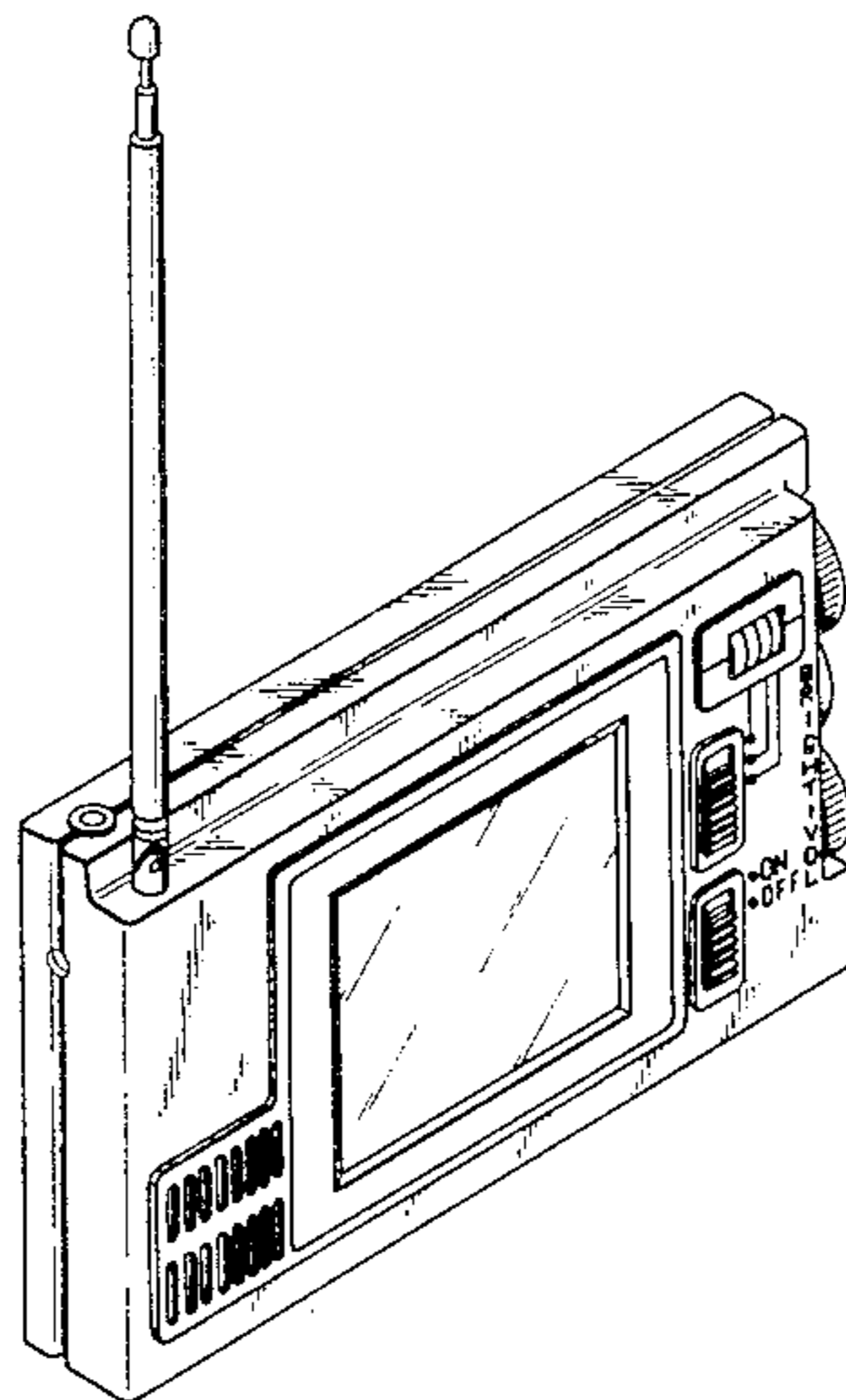

FIG. 1

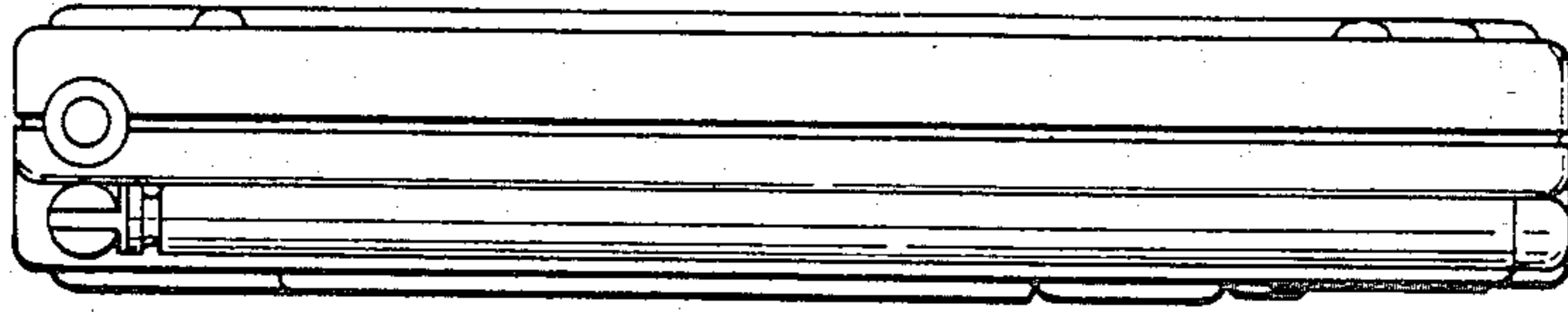
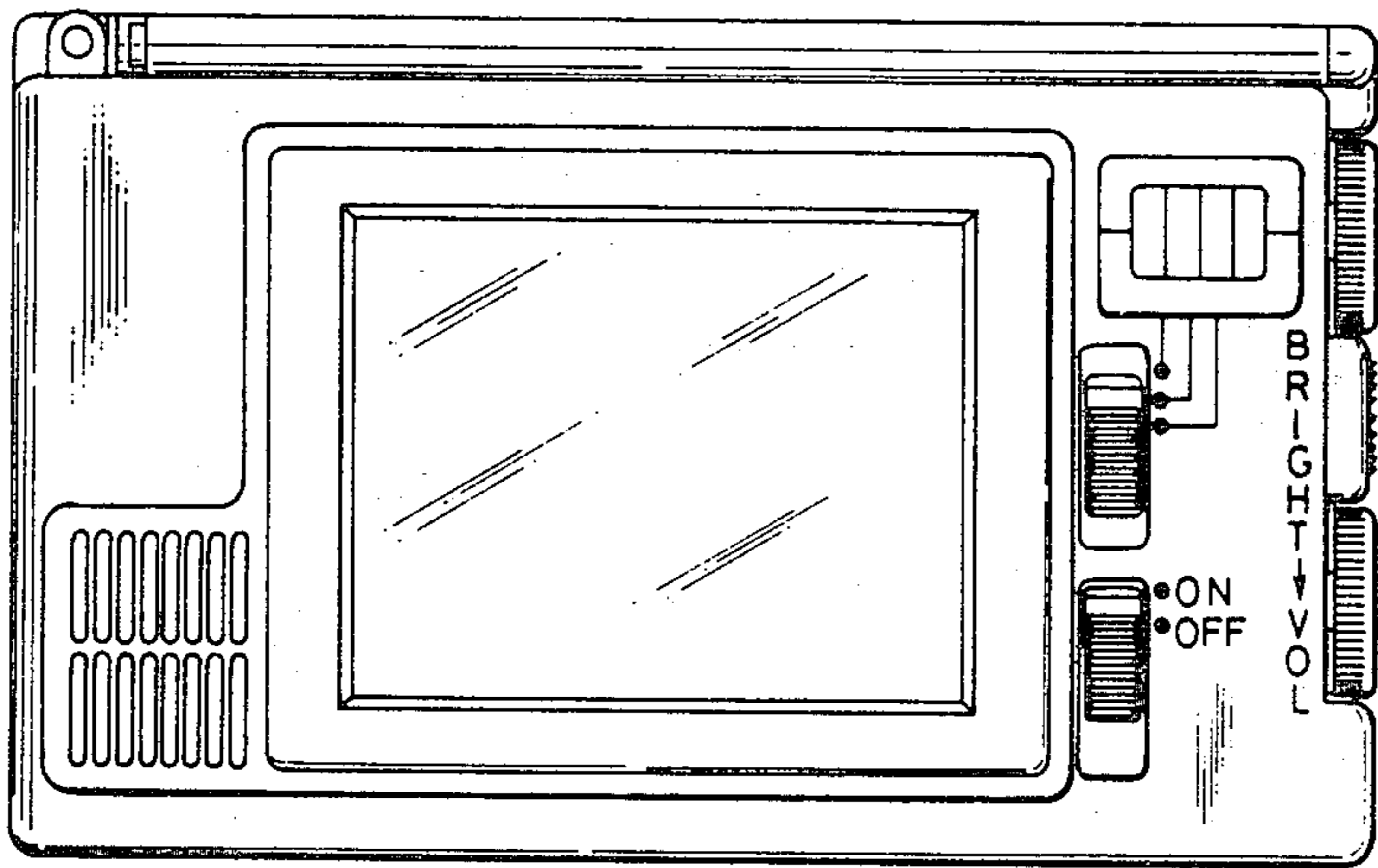

FIG. 2

VI ←



VI ←

FIG. 3

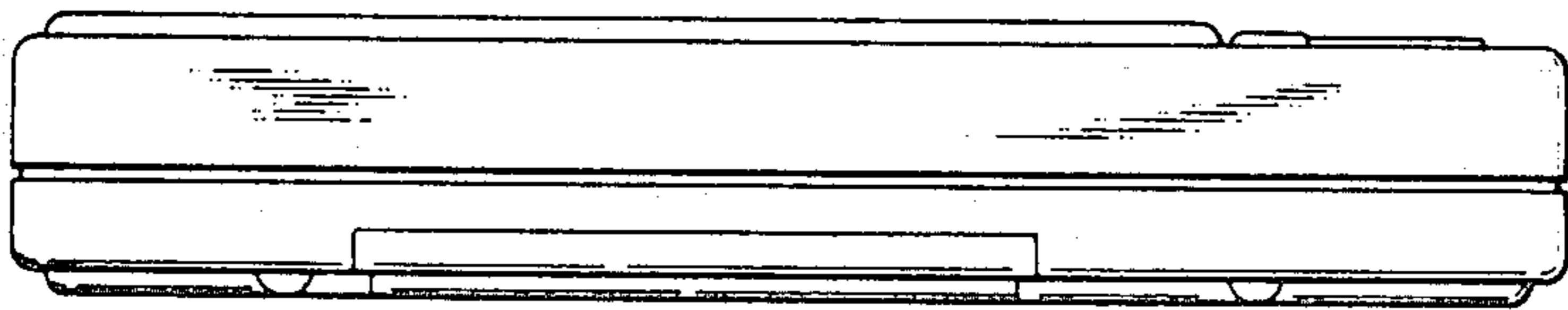

FIG. 4

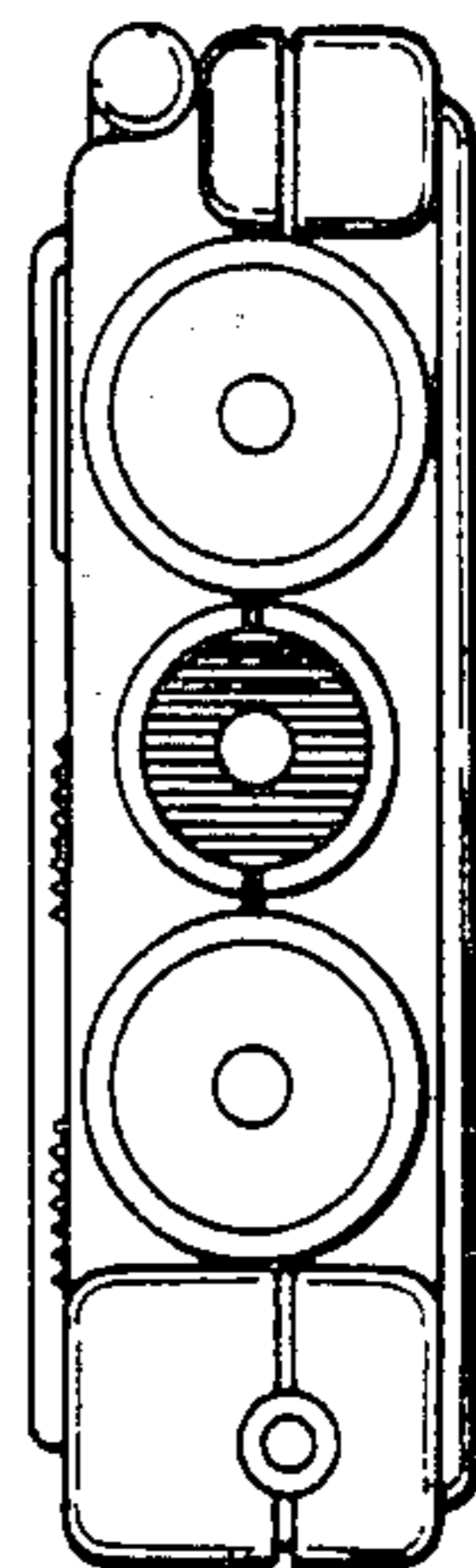

FIG. 5

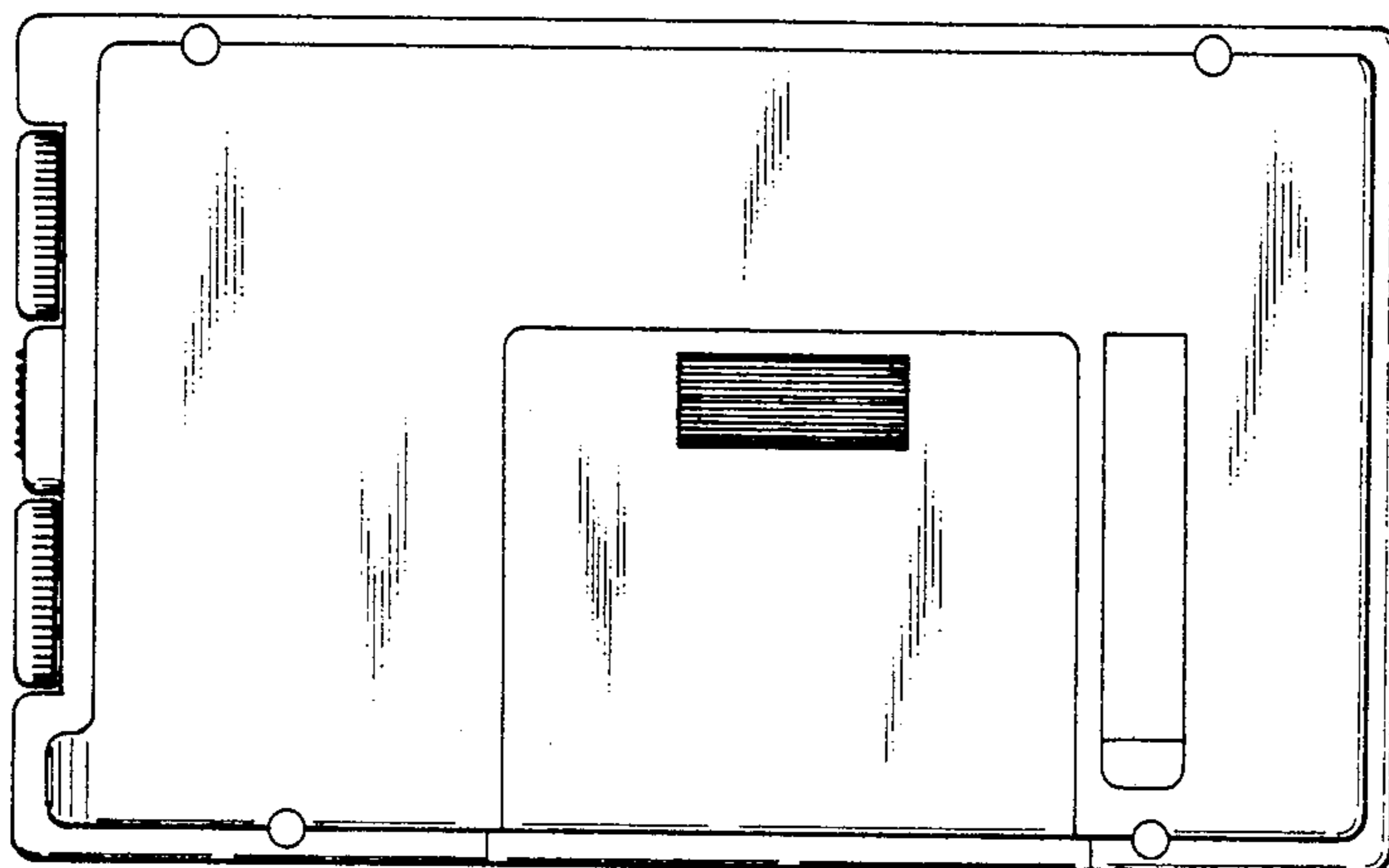

FIG. 6

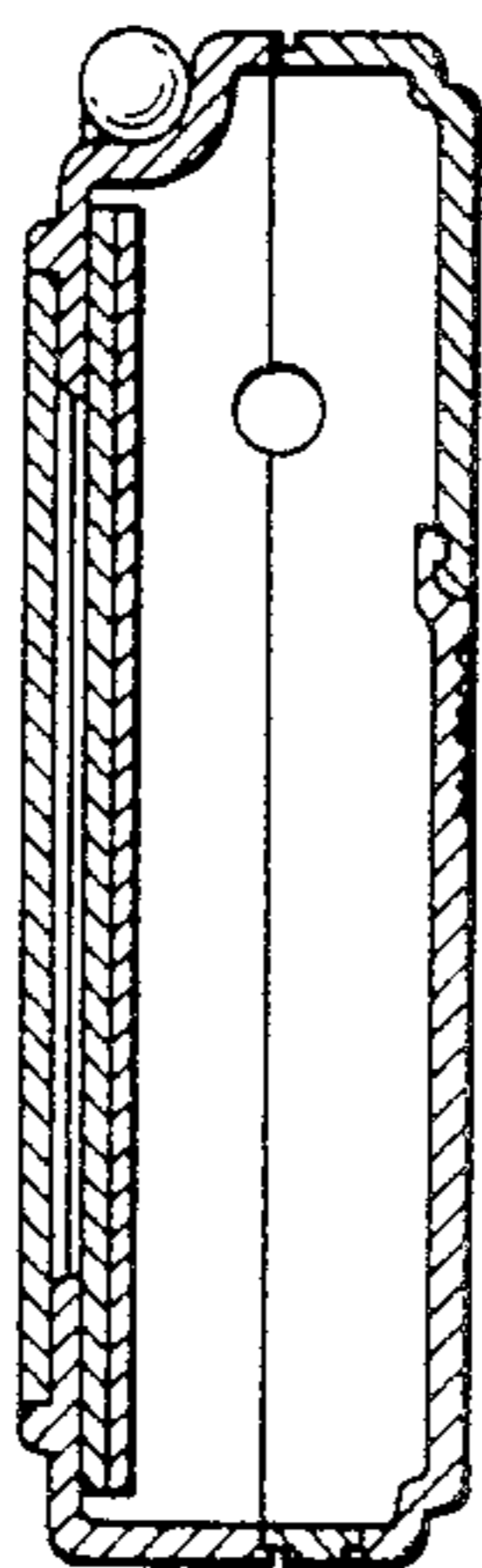

FIG. 7

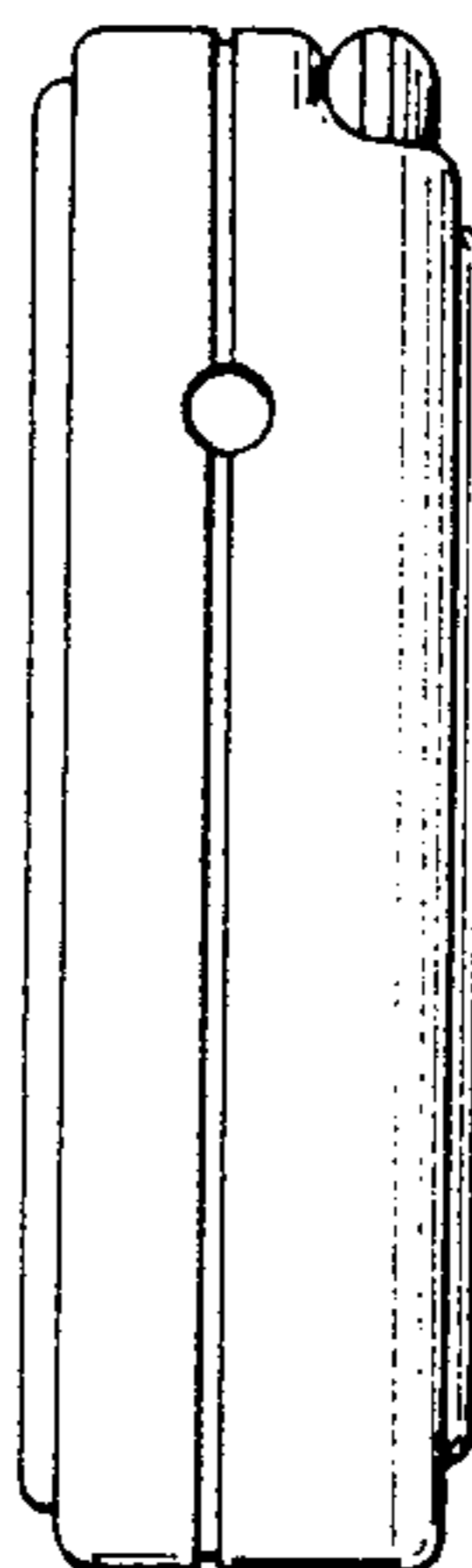

FIG. 8

