

[54] ORIGINAL FEEDER FOR COPYING MACHINE

4,203,585	5/1980	Kunz	271/4
4,270,746	6/1981	Hamlin	371/35 X
4,279,504	7/1981	Brown	271/3.1 X
4,460,269	7/1984	Yamazaki	271/3.1 X

[75] Inventors: Kunio Hara, Chiba; Tooru Okuyama, Isehara, both of Japan

Primary Examiner—Nelson C. Holtje
Attorney, Agent, or Firm—Finnegan, Henderson, Farabow, Garrett & Dunner

[73] Assignee: Tokyo Shibaura Denki Kabushiki Kaisha, Japan

[**] Term: 14 Years

[57] CLAIM

[21] Appl. No.: 539,002

The ornamental design for an original feeder for copying machine, substantially as shown.

[22] Filed: Oct. 4, 1983

DESCRIPTION

[30] Foreign Application Priority Data

Apr. 7, 1983 [JP] Japan 58-14329

[52] U.S. Cl. D16/32; D16/27

[58] Field of Search D16/30, 31, 32, 27;
271/3, 3.1, 4, 9, 35, 171, 273-274, 280, 284,
287-297, 305; D14/110, 114

FIG. 1 is a front, top and left side perspective view of an original feeder for copying machine showing our new design;

FIG. 2 is a front elevational view thereof;

FIG. 3 is a top plan view thereof;

FIG. 4 is a left side elevational view thereof;

FIG. 5 is a right side elevational view thereof;

FIG. 6 is a rear elevational view thereof;

FIG. 7 is a bottom plan view thereof; and

FIG. 8 is a perspective view of FIG. 1; the broken-line showing of a copying machine is environmental only and forms no part of the claimed design.

[56] References Cited

U.S. PATENT DOCUMENTS

D. 197,996	4/1964	Abend	D16/31
D. 234,005	12/1974	Yagi	D16/27
D. 276,238	11/1984	Kosako	D16/32

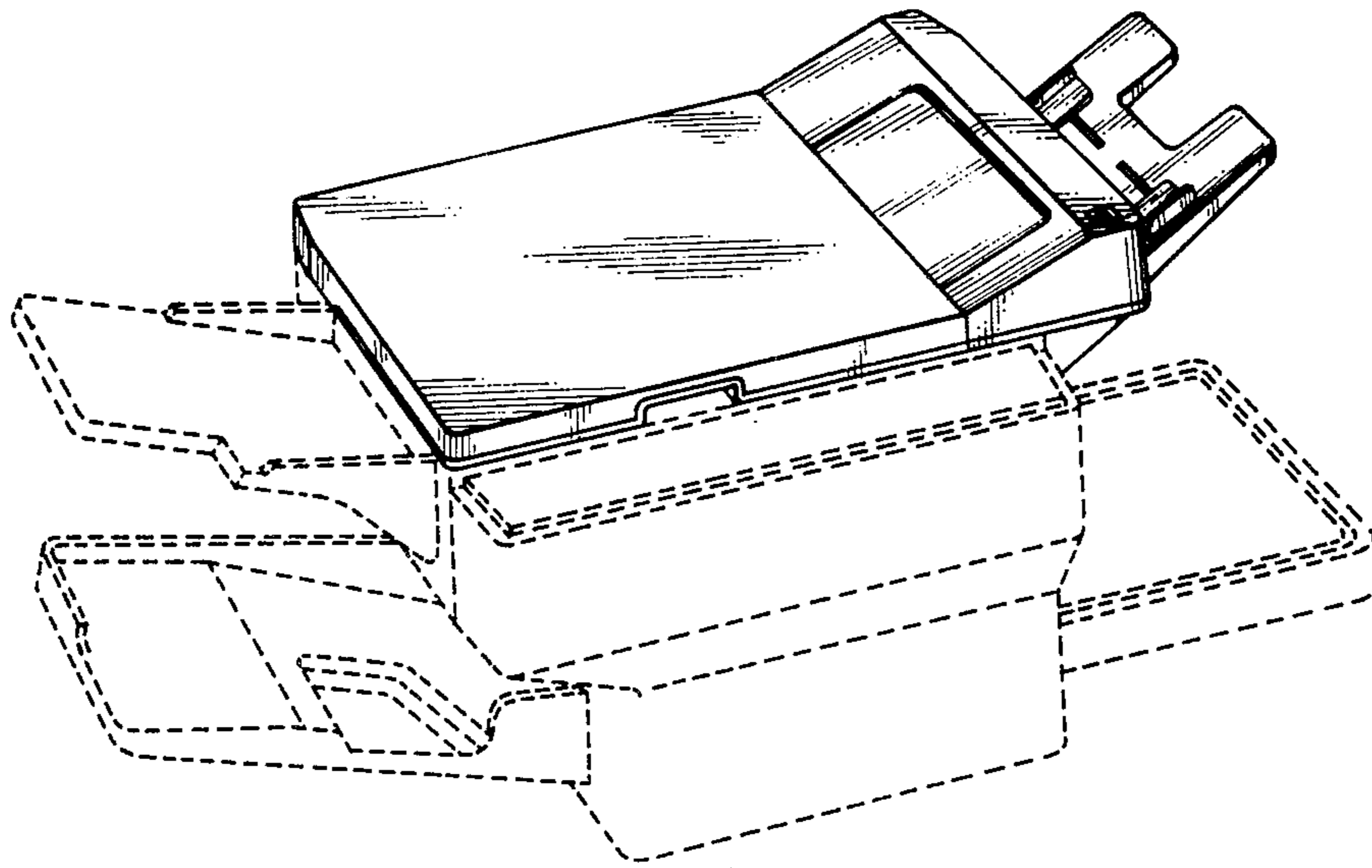

FIG. 1

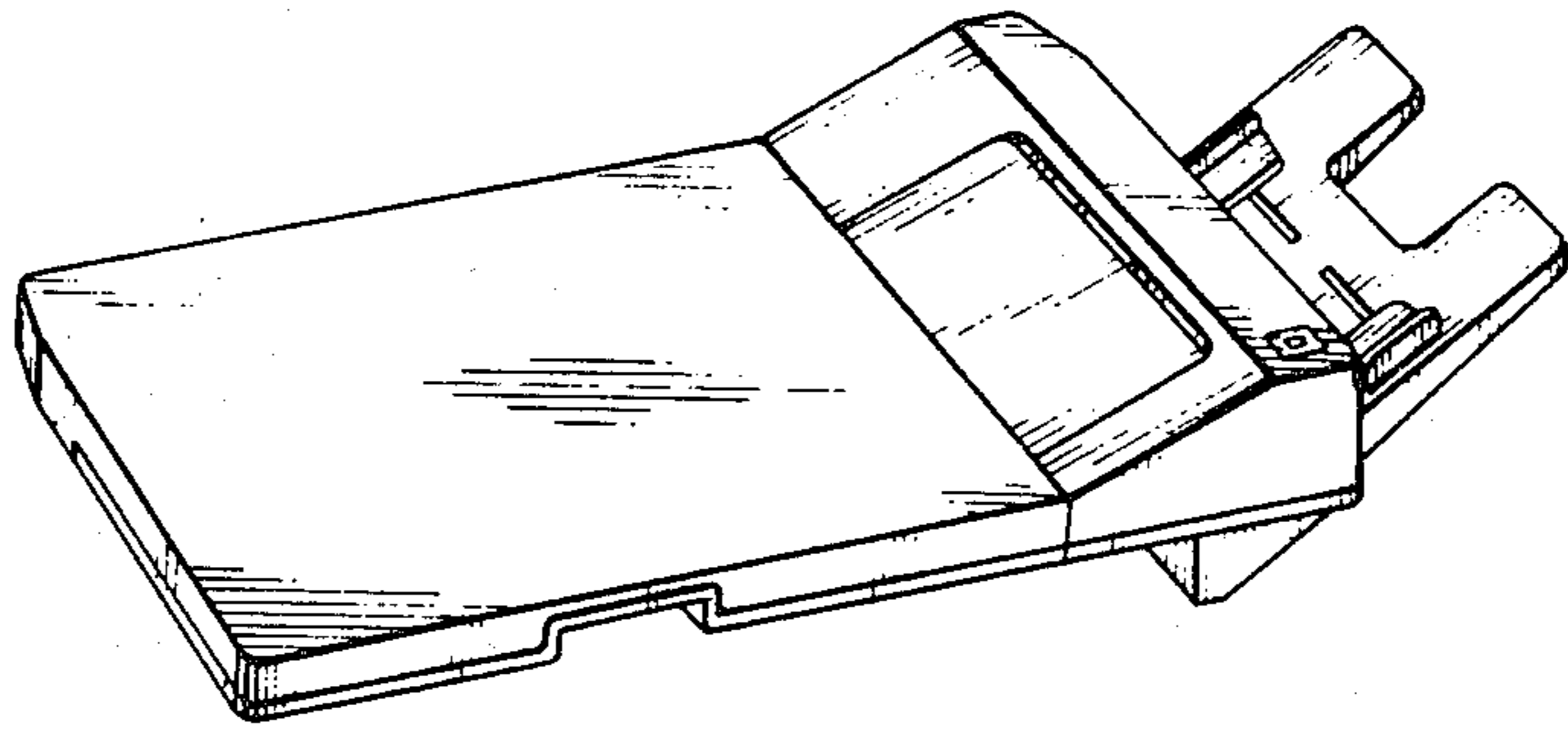

FIG. 2

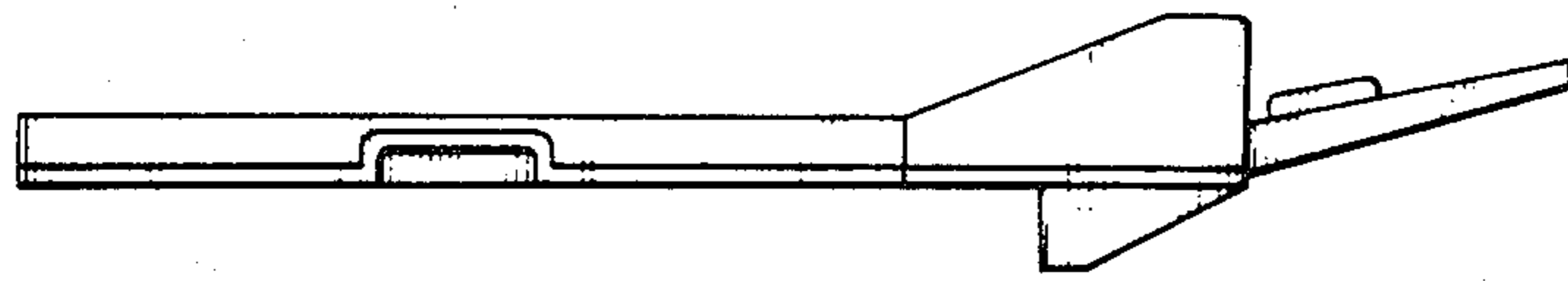

FIG. 3

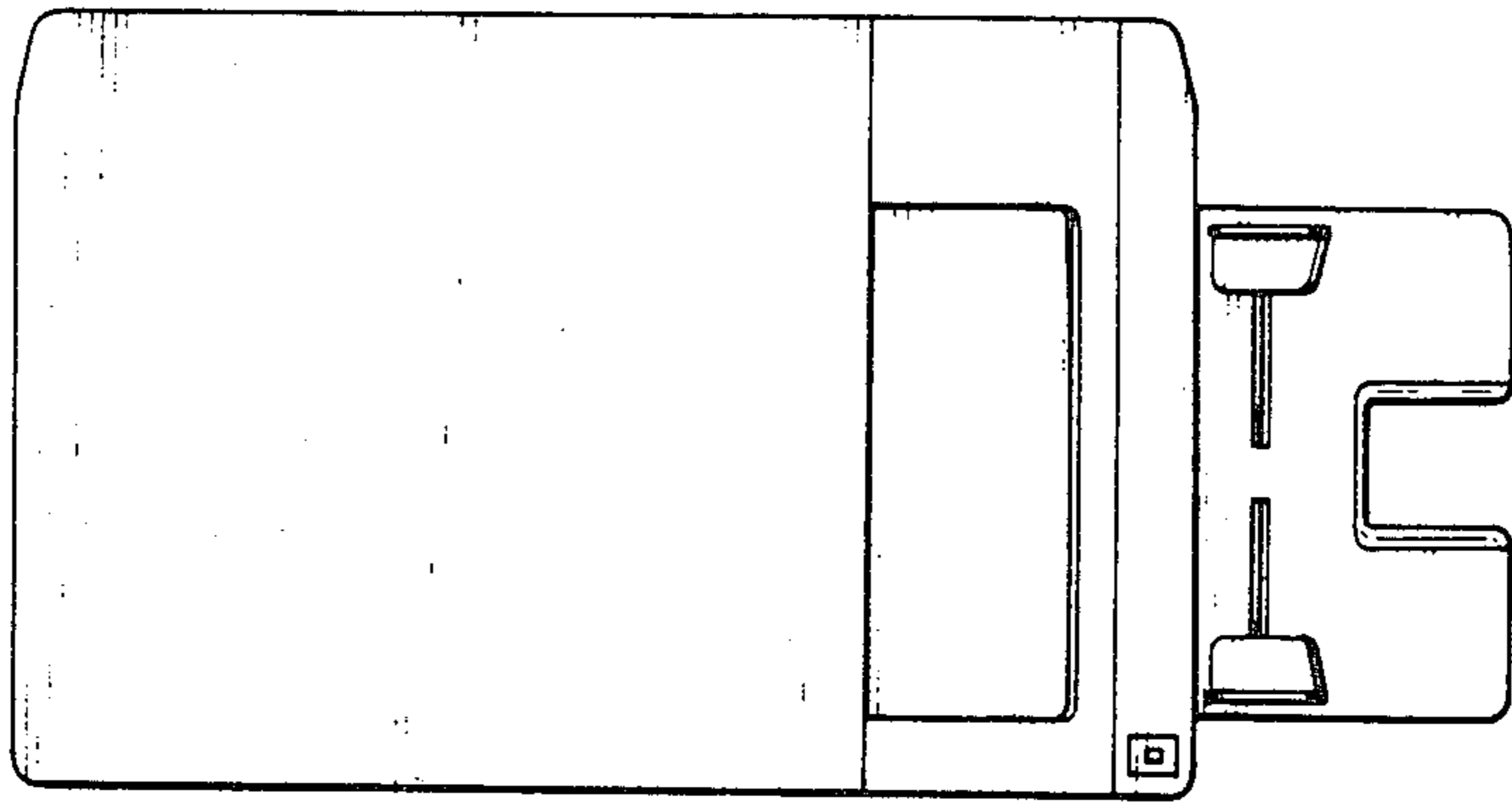

FIG. 4

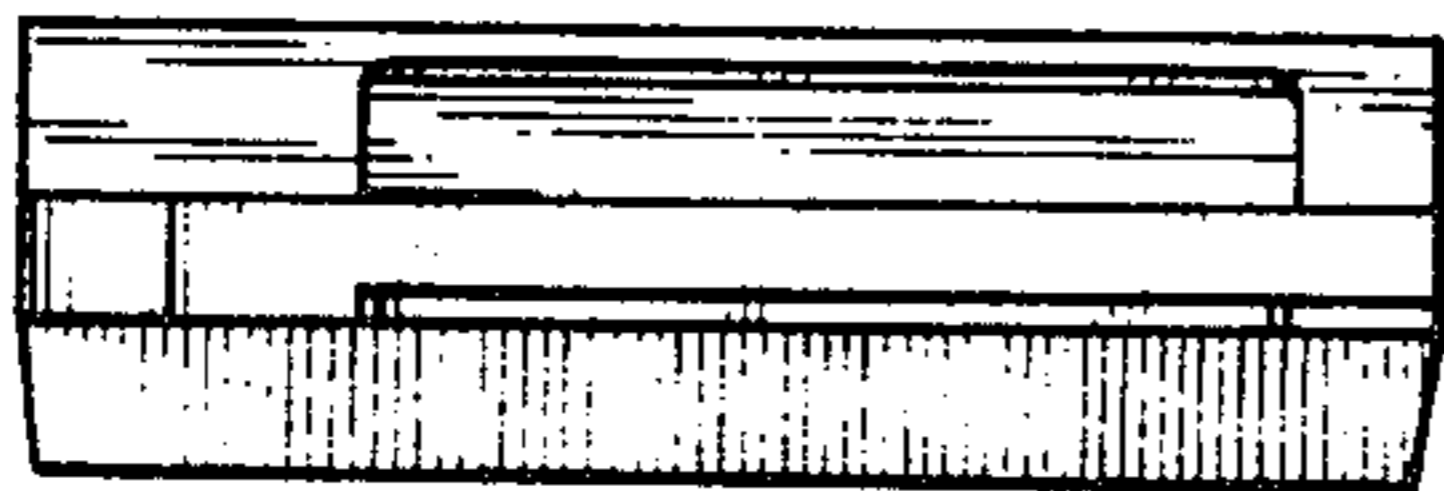

FIG. 5

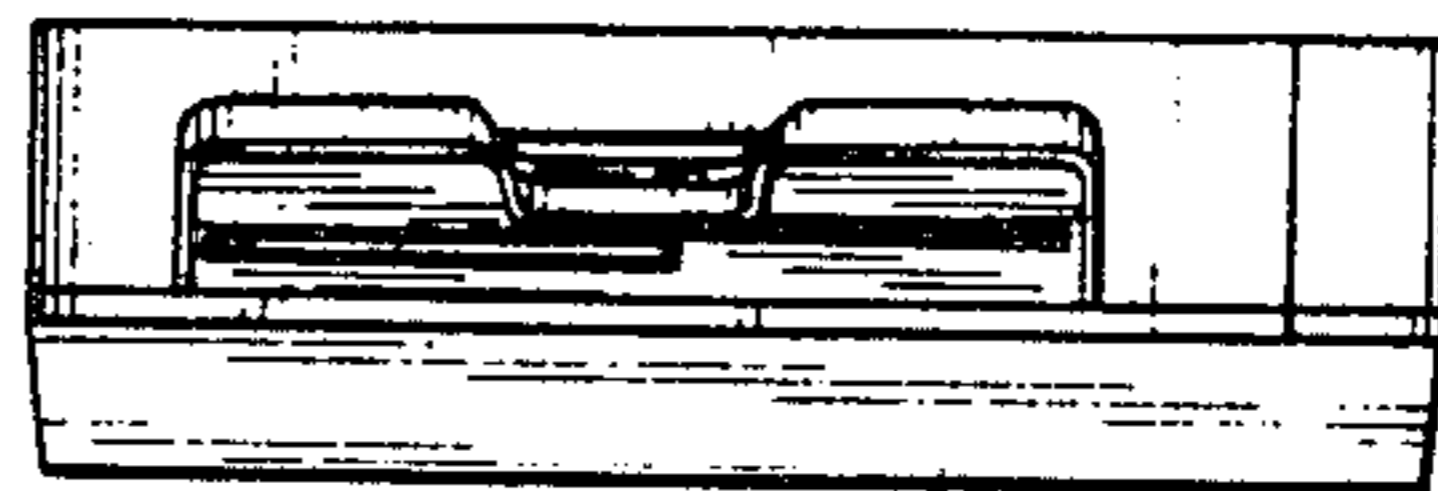

FIG. 6

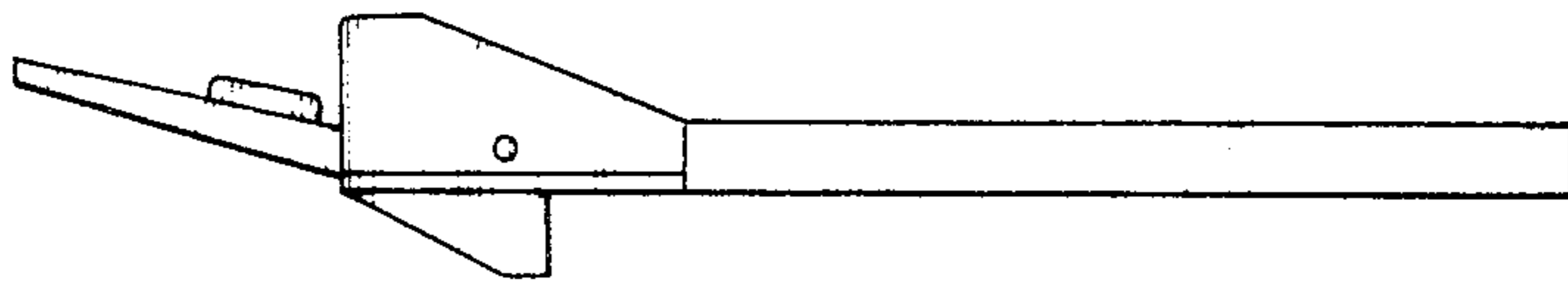

FIG. 7

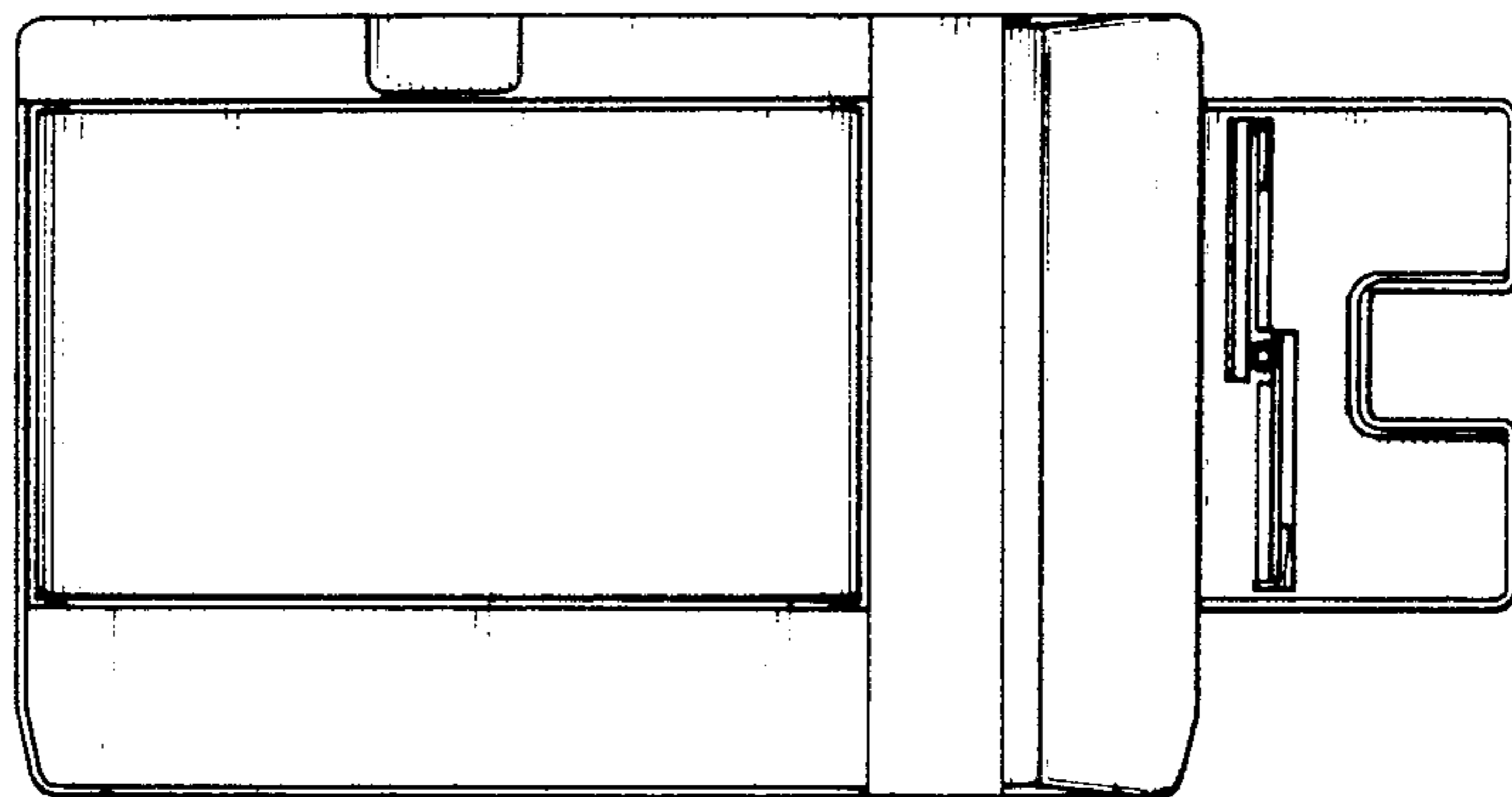

FIG. 8

