

[54] HEATED HAIR BRUSH

[75] Inventor: James M. Rittenhouse, Watchung, N.J.

[73] Assignee: Conair Corporation, Edison, N.J.

[\*\*] Term: 14 Years

[21] Appl. No.: 511,643

[22] Filed: Jul. 7, 1983

[52] U.S. Cl. .... D28/35; D4/128

[58] Field of Search ..... D28/9, 10, 12, 13, 15-18, D28/21, 24, 25, 28, 29, 35, 99; 34/98-101; 219/222, 225; 132/9, 35 R, 35 A; D4/128

[56] References Cited

U.S. PATENT DOCUMENTS

- D. 260,692 9/1981 Rakocy et al. .... D28/35
- D. 270,954 10/1983 Mizobata et al. .... D28/35

OTHER PUBLICATIONS

*HFD-Retailing Home Furnishings*, 7/9/79, Section Two-p. 62-Dazey Super Beauty Curl at lower left.  
*HFD-Retailing Home Furnishings*, 5/12/80, p. 33-Conair Power Handle at upper right.

Primary Examiner—Louis S. Zarfes  
Attorney, Agent, or Firm—Haynes N. Johnson

[57] CLAIM

The ornamental design for a heated hair brush, substantially as shown and described.

DESCRIPTION

FIG. 1 is a perspective view of a heated hair brush showing my new design, it being understood that the teeth are continuous over the span indicated by dot-dash line and the conventional power cord is broken away for ease of illustration.

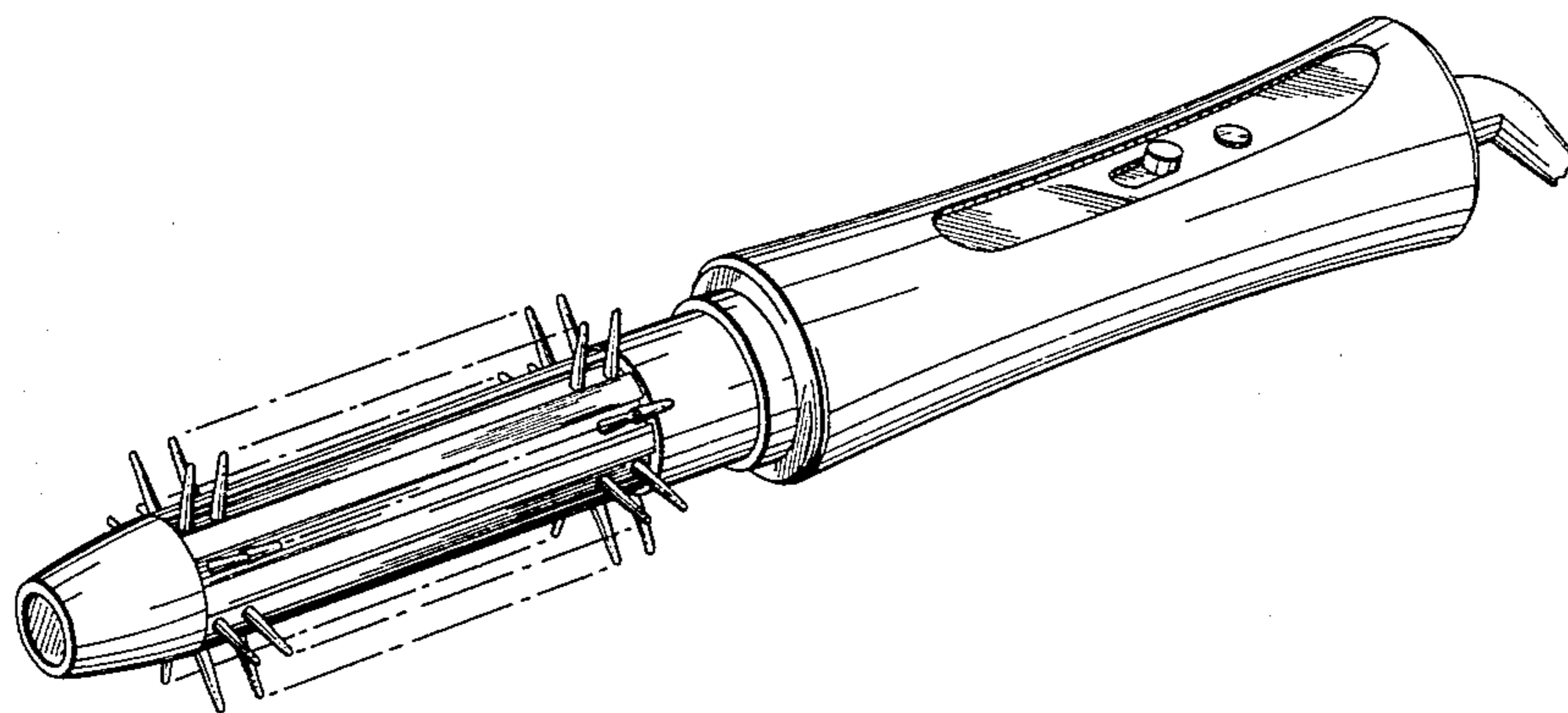
FIG. 2 is a front elevational view thereof;

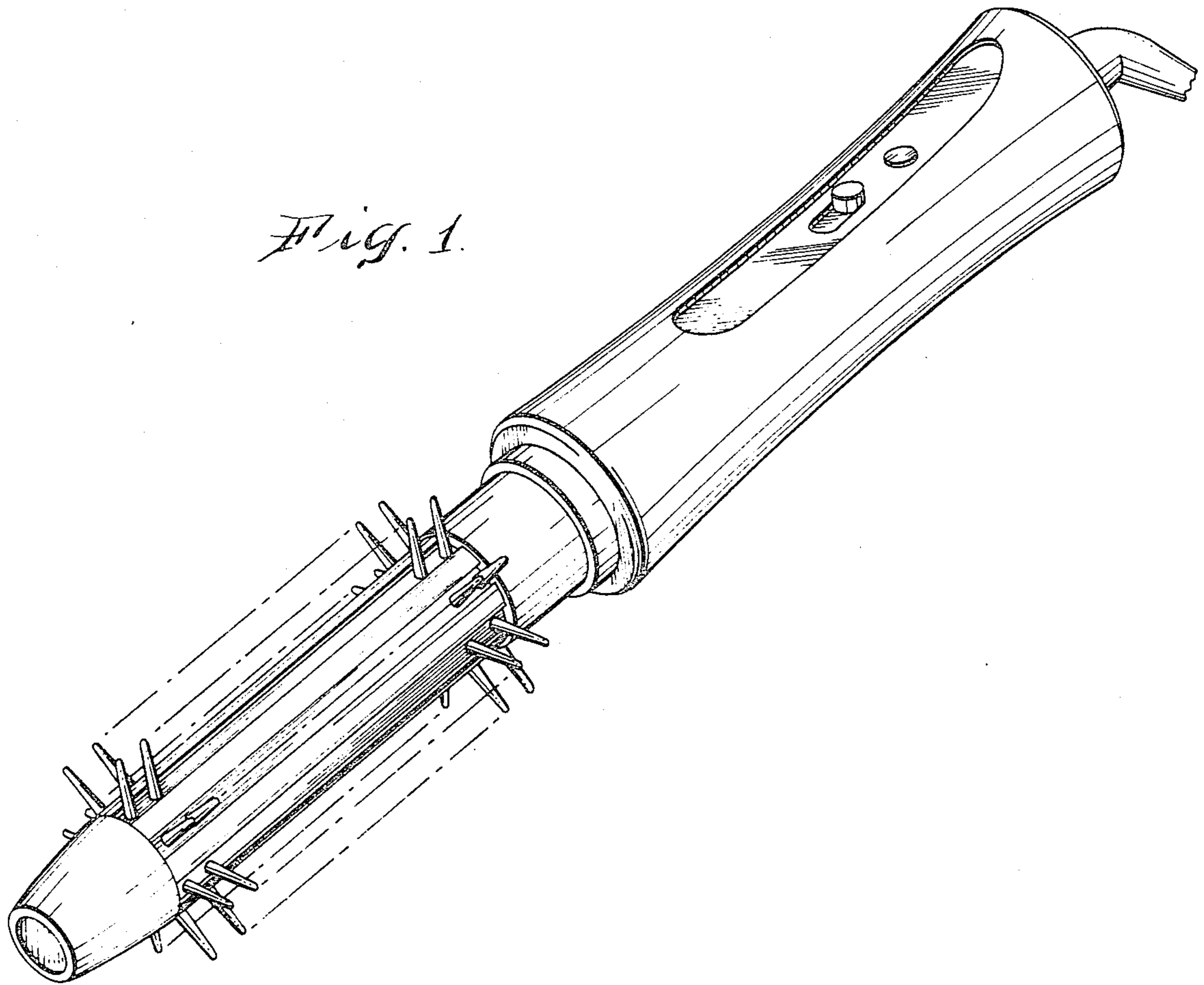
FIG. 3 is a rear elevational view thereof;

FIG. 4 is a top plan view thereof;

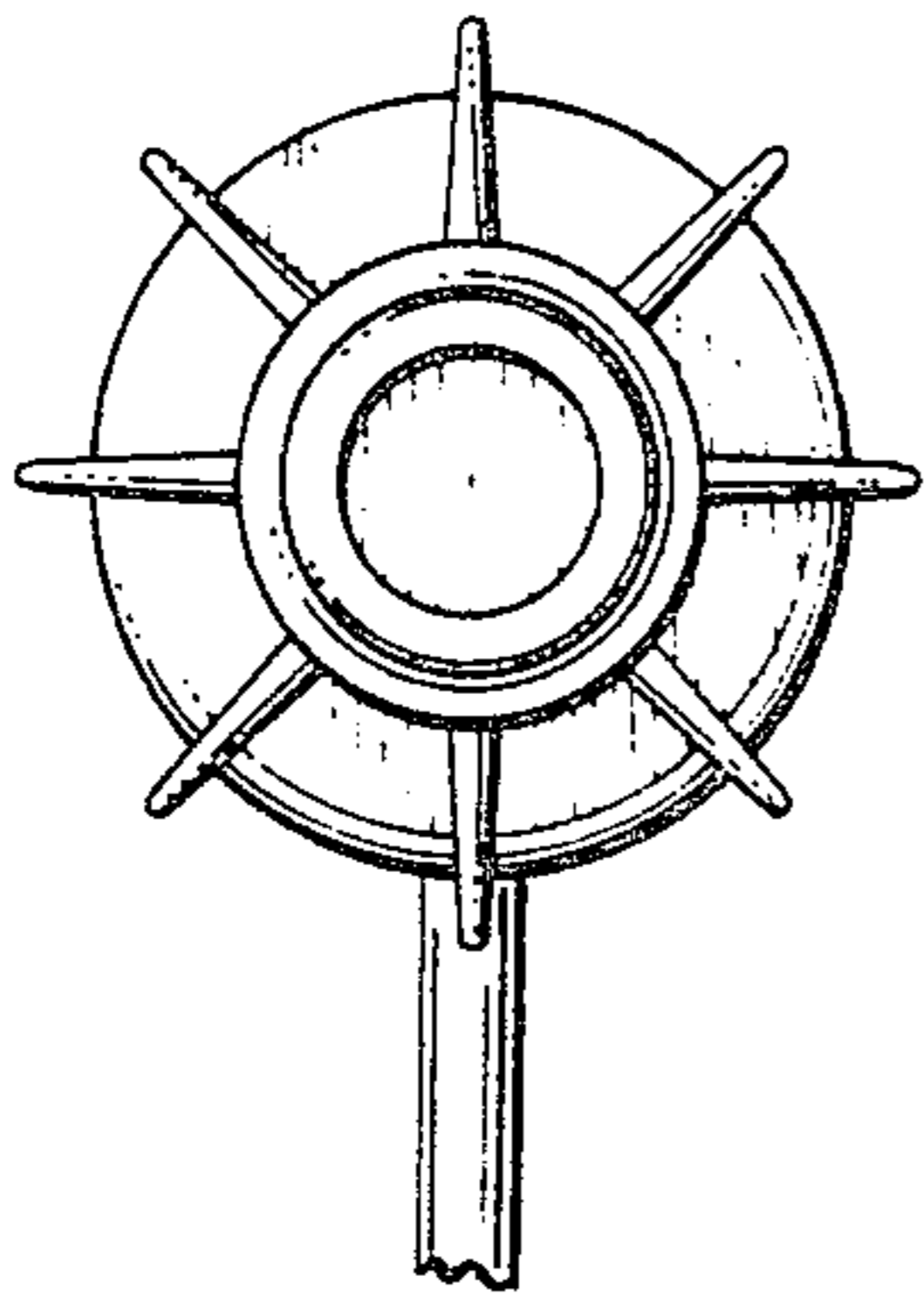
FIG. 5 is a left side elevational view; the right side is a mirror image thereof;

FIG. 6 is a bottom plan view thereof.

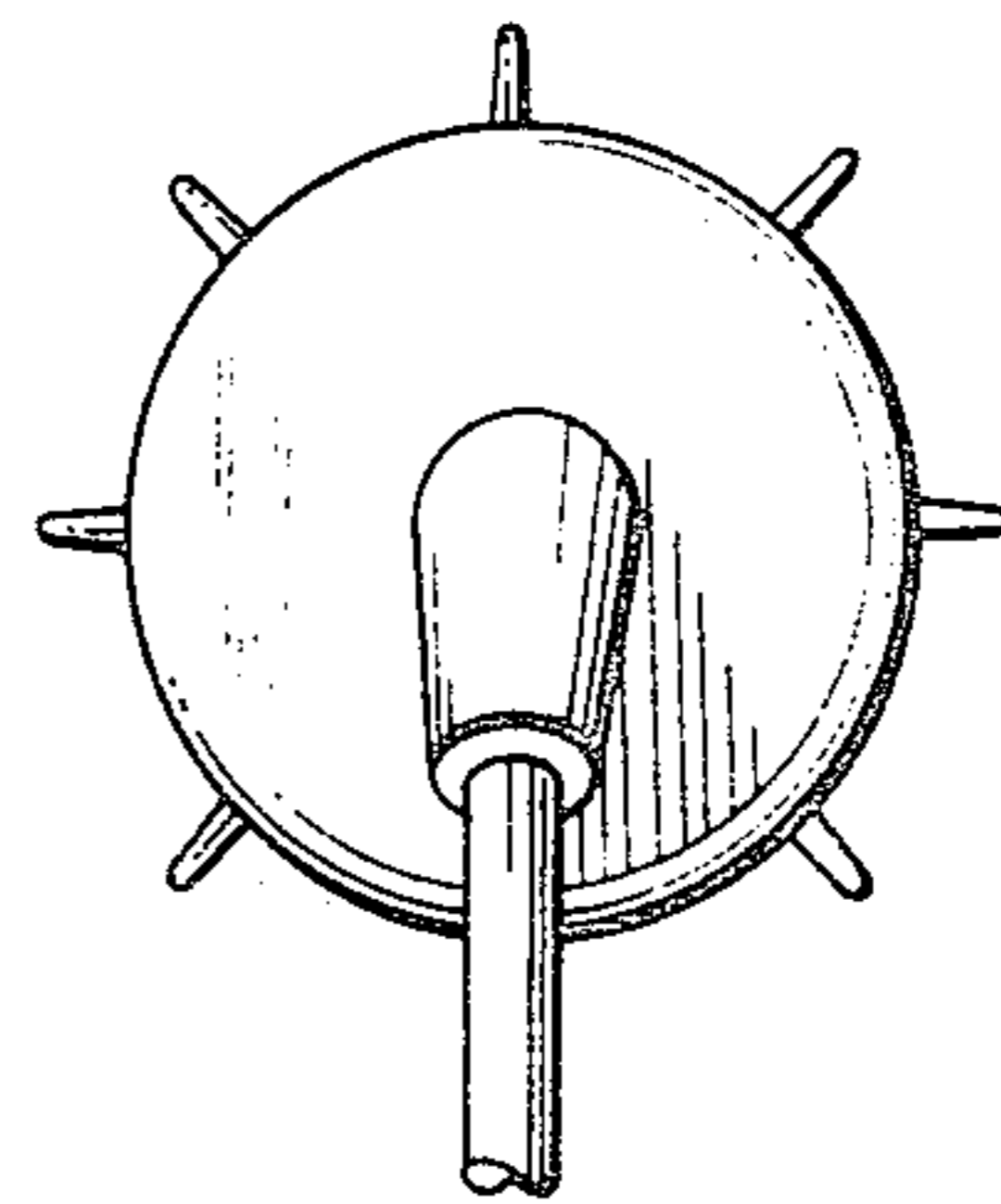




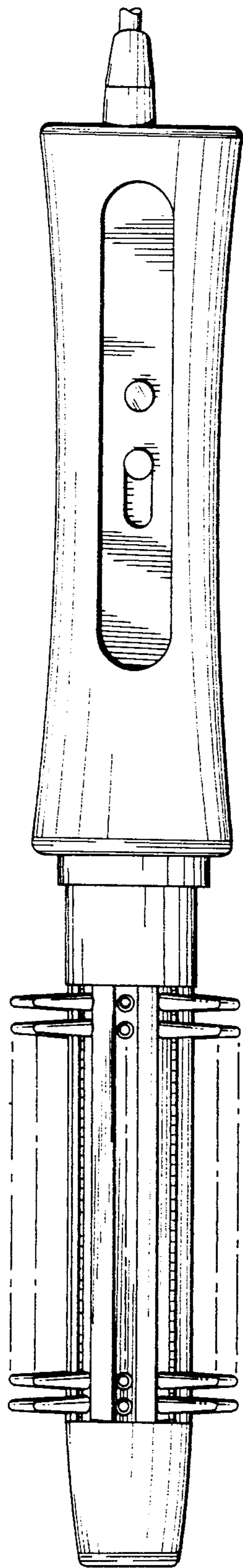
*Fig. 1.*



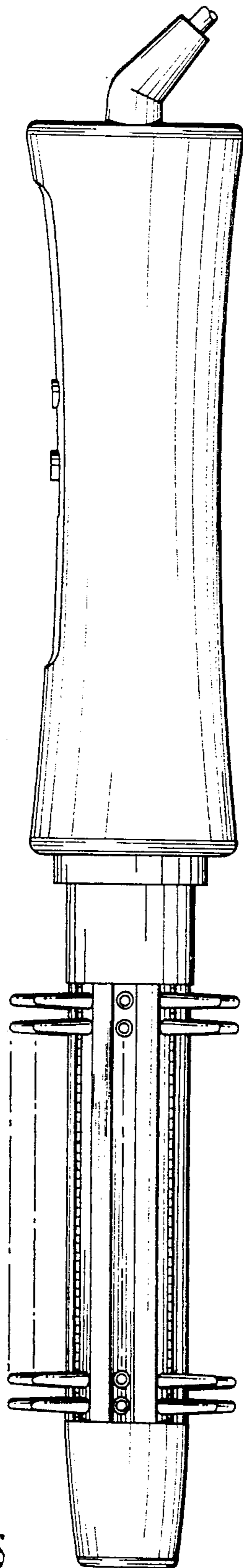
*Fig. 2.*



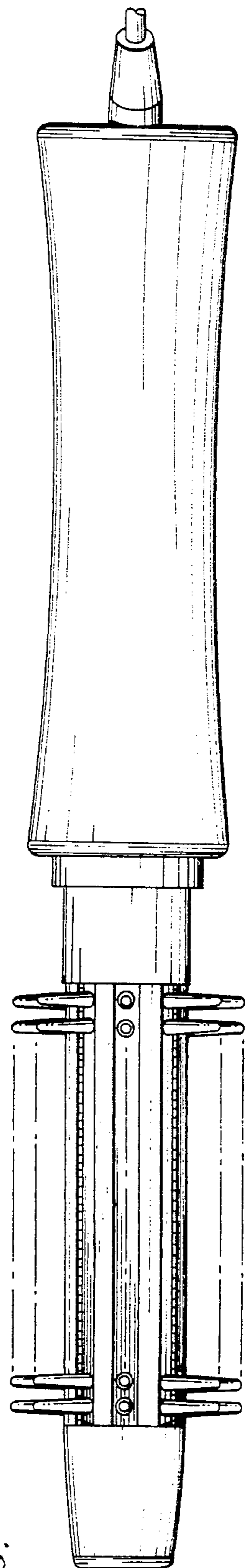
*Fig. 3.*



*Fig. 4.*



*Fig. 5.*



*Fig. 6.*