

[54] TOY ROBOT CONVERTIBLE INTO A HELICOPTER

[75] Inventor: Katsushi Murakami, Tokyo, Japan

[73] Assignee: Bandai Co., Ltd., Japan

[**] Term: 14 Years

[21] Appl. No.: 418,828

[22] Filed: Sep. 16, 1982

[52] U.S. Cl. D21/150; D21/85

[58] Field of Search D21/150, 148, 166, 85; 46/22, 17, 115, 116, 201, 202

[56] References Cited

U.S. PATENT DOCUMENTS

4,095,367	6/1978	Ogawa	46/120
4,170,840	10/1979	Ogawa	46/22
4,183,173	1/1980	Ogawa	46/22
4,206,564	6/1980	Ogawa	46/22

4,391,060 7/1983 Nakane 46/17

Primary Examiner—Melvin B. Feifer
Attorney, Agent, or Firm—R. Gale Rhodes, Jr.

[57] CLAIM

The ornamental design for toy robot convertible into a helicopter, as shown and described.

DESCRIPTION

FIG. 1 is a front elevation view of a toy robot convertible into a helicopter according to the design; FIG. 2 is a rear elevation view of the toy robot; FIG. 3 is a right side elevation view of the toy robot, a left side elevation view being omitted which is symmetrical thereto; FIG. 4 is a plan view of the toy robot; FIG. 5 is a bottom view of the toy robot; and FIG. 6 is a modified form of the toy robot when converted to a helicopter; FIG. 7 is a top plan view of FIG. 6.

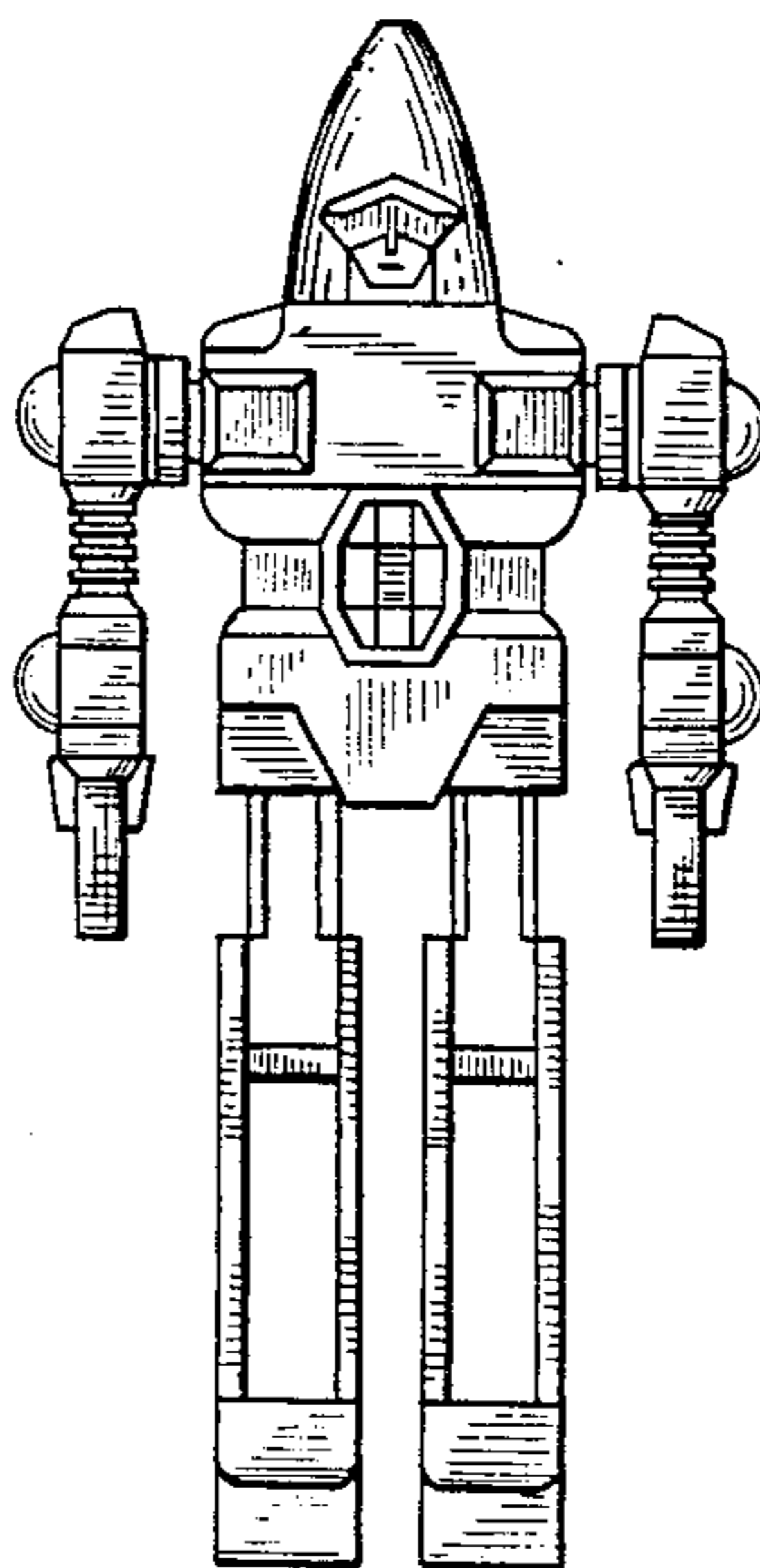

FIG. 2

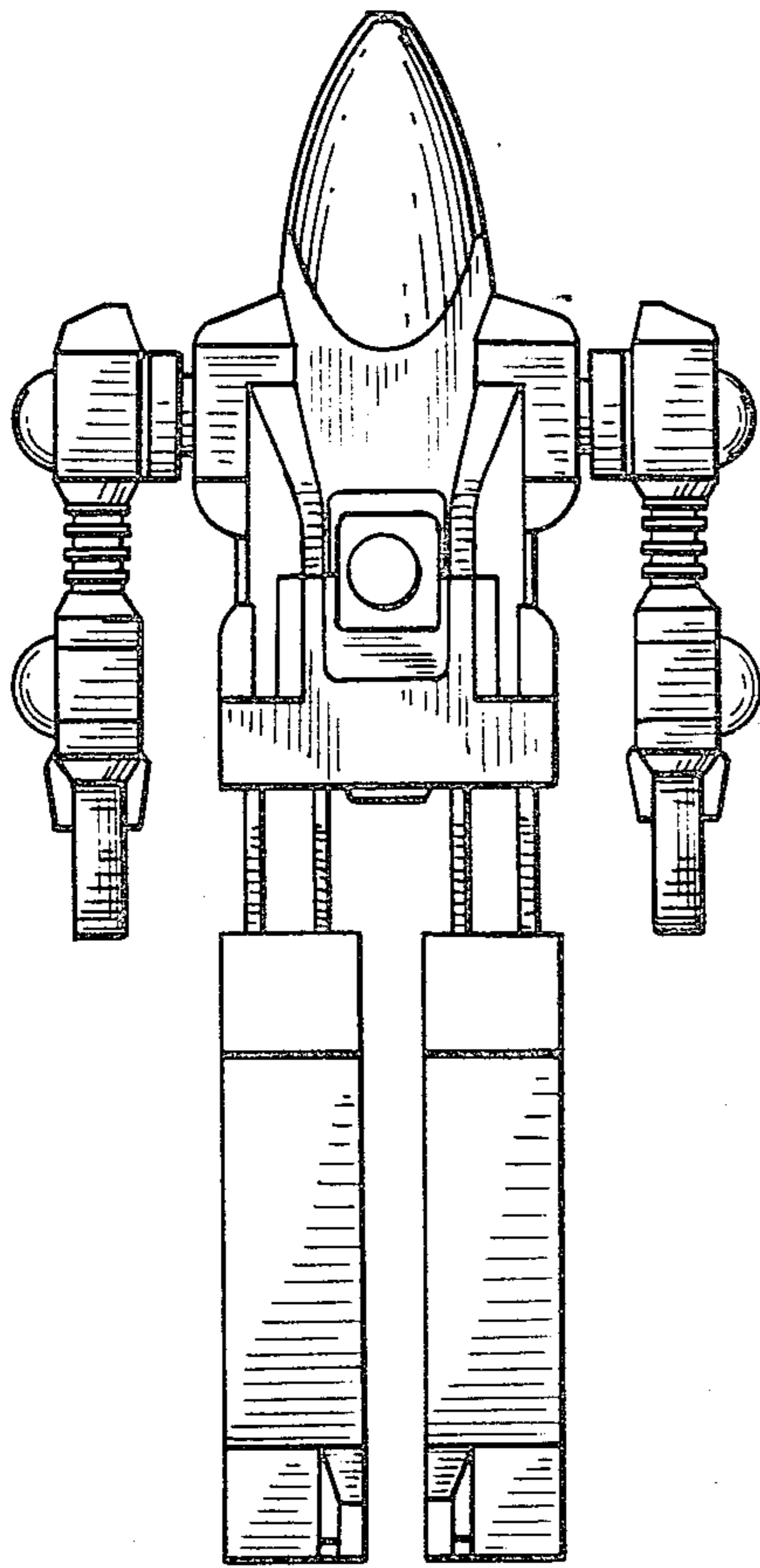

FIG. 1

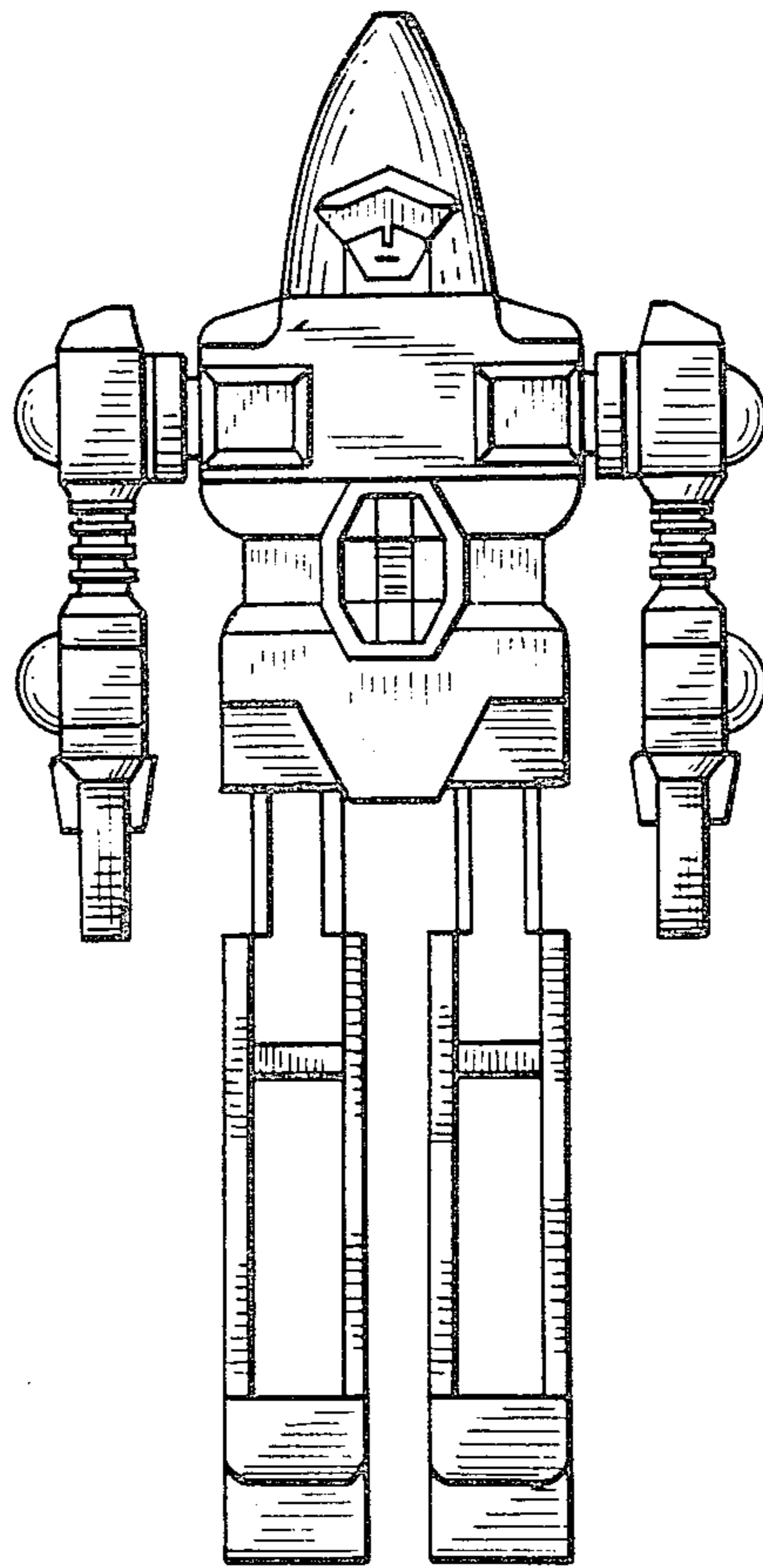

FIG. 4

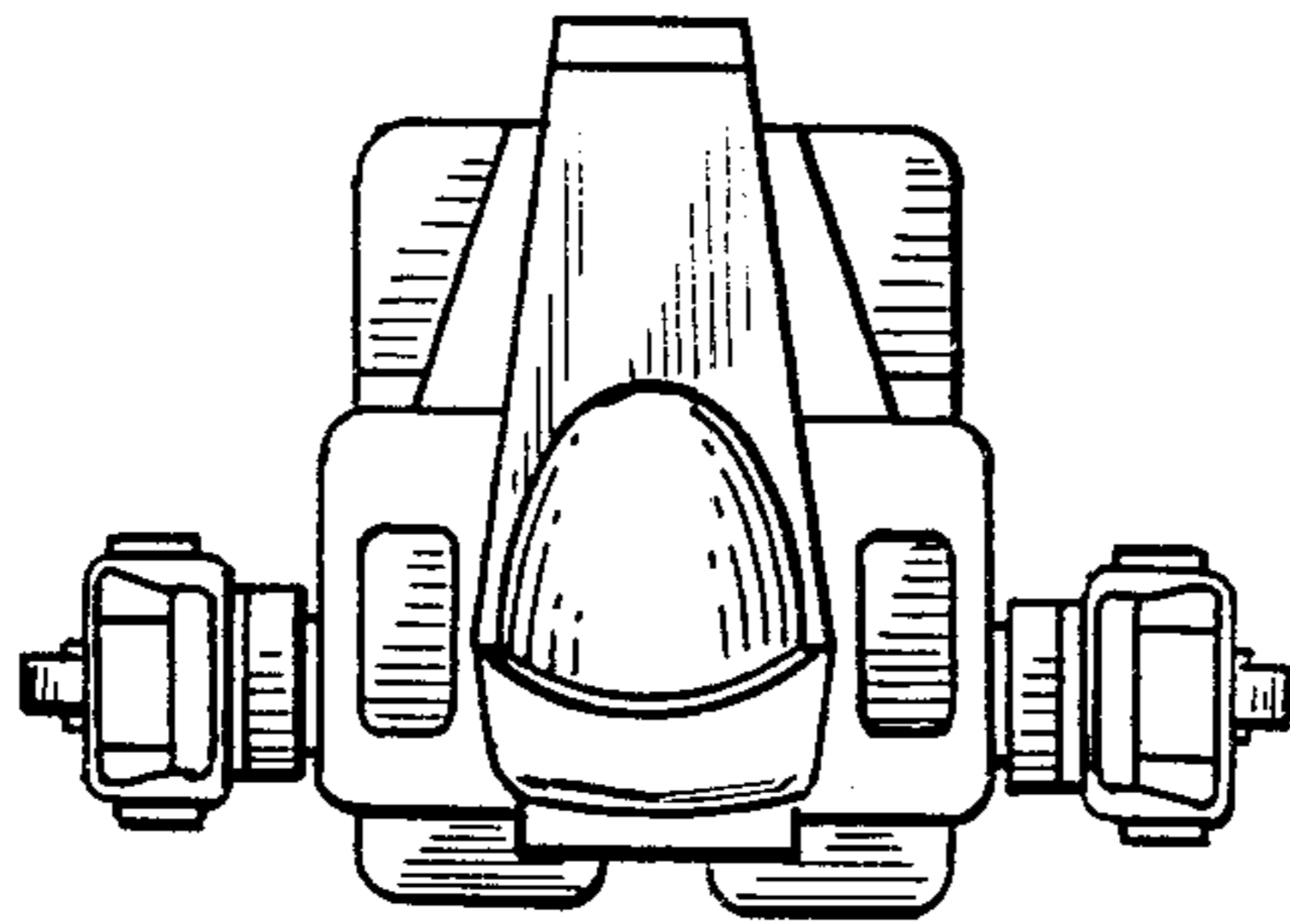

FIG. 3

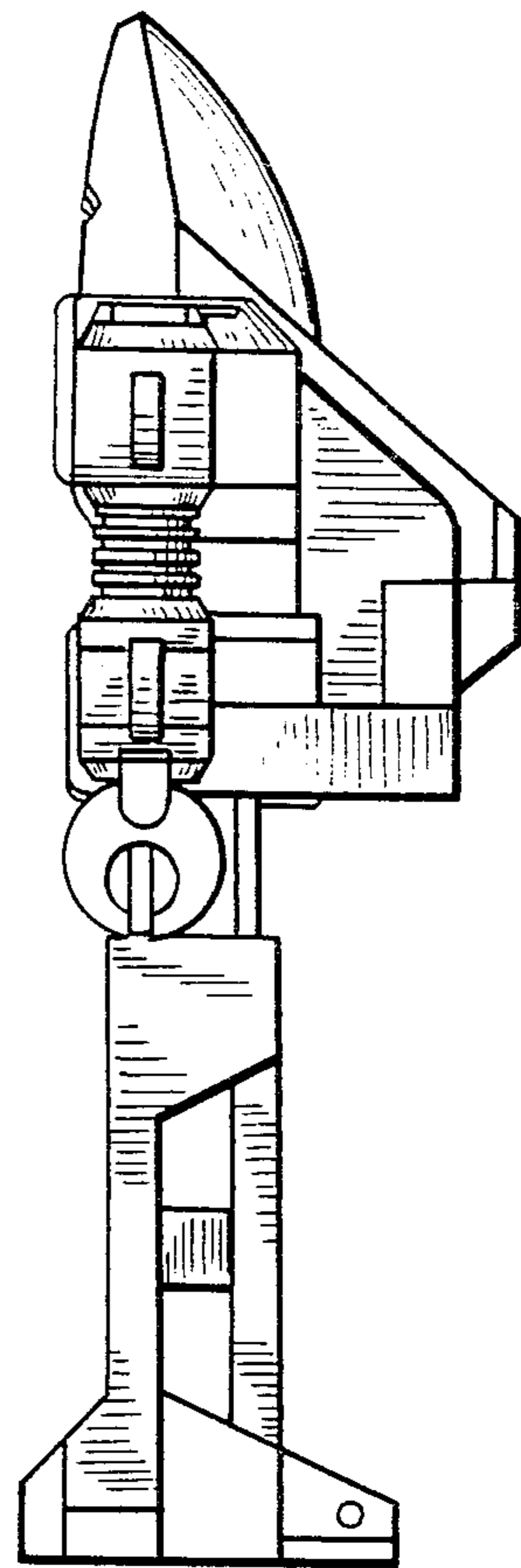

FIG. 5

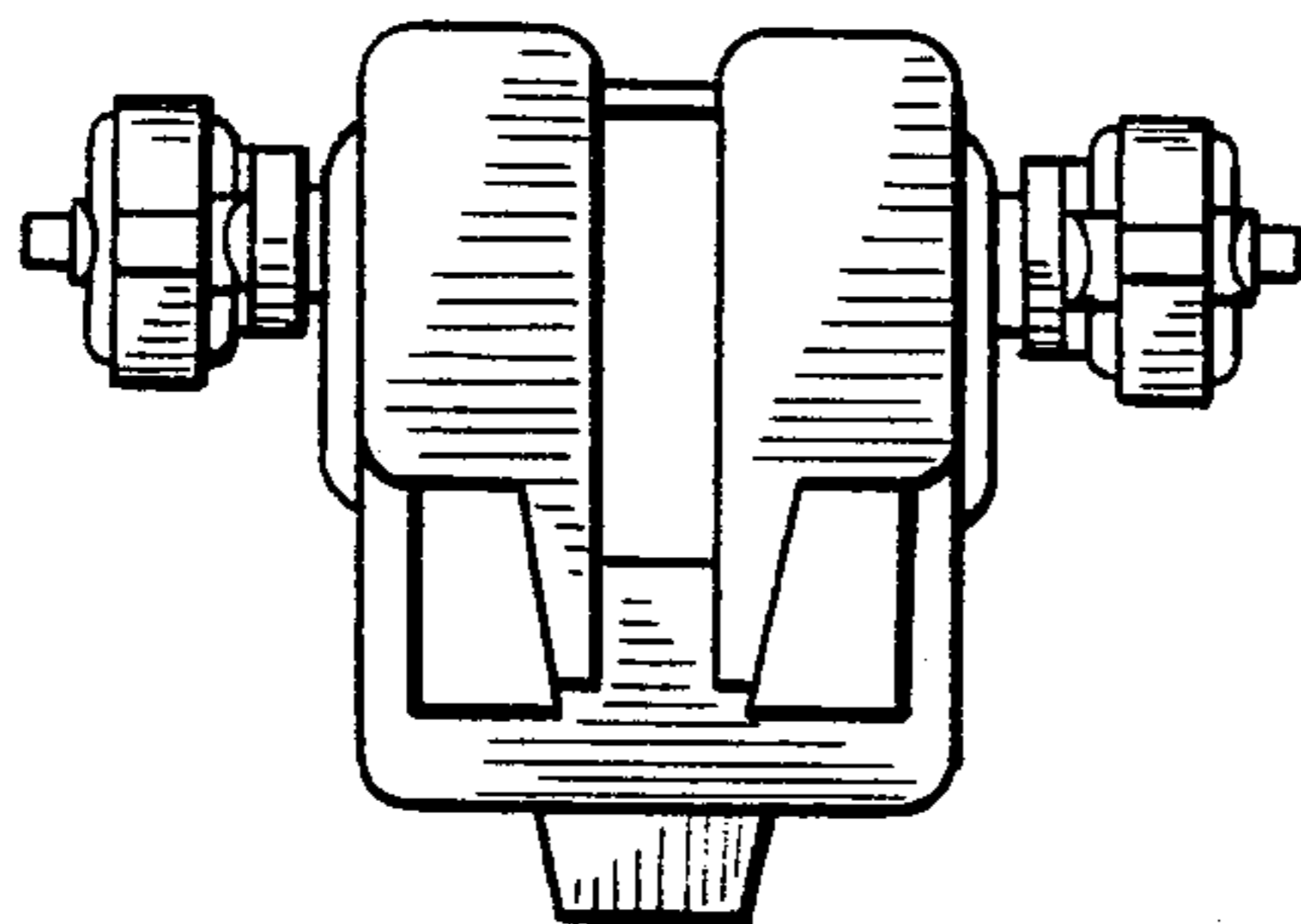

FIG. 6

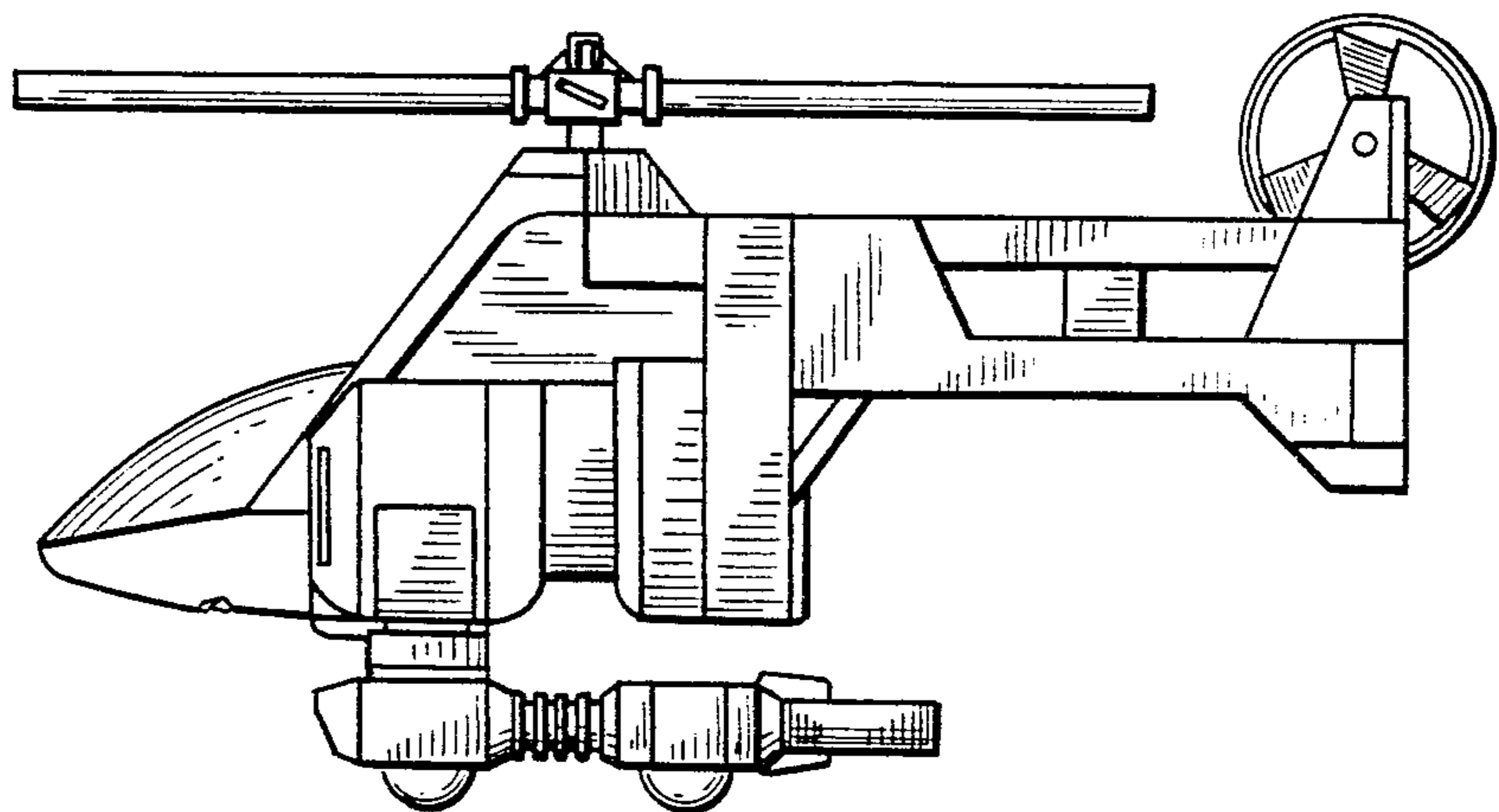

FIG. 7

