

[54] NOVELTY BEANIE

[76] Inventor: Dee A. Smith, Rte. 1, Box 91E, Palmer, Tex. 75152

[**] Term: 14 Years

[21] Appl. No.: 520,505

[22] Filed: Aug. 4, 1983

[52] U.S. Cl. D2/248; D2/256

[58] Field of Search D2/230, 231, 239, 240, D2/244, 246, 248, 250, 251, 385, 256; 2/175 R, 185 R, 195, 199; 273/DIG. 17; 272/8 N; 446/27

[56] References Cited

U.S. PATENT DOCUMENTS

2,907,138 10/1959 Kolwicz 446/27

OTHER PUBLICATIONS

Premium Practice, Mar. 1958, p. 64; "Mickey Mouse" Beanie, left, center on page.

Playthings, Mar. 1959, p. 86; "Horn Head" Novelty Head Wear on page.

"Astro Hats" by Metal Impressions Inc., ©1979; Hat with Sky Wings, top right on page.

Primary Examiner—Carmen H. Vales

Attorney, Agent, or Firm—Richards, Harris, Medlock & Andrews

[57] CLAIM

The ornamental design for a novelty beanie, as shown and described.

DESCRIPTION

FIG. 1 is a perspective view of a novelty beanie showing my new design;

FIG. 2 is a front elevational view thereof;

FIG. 3 is a rear elevational view thereof;

FIG. 4 is a left side elevational view thereof;

FIG. 5 is a right side elevational view thereof;

FIG. 6 is a top plan view thereof; and

FIG. 7 is a bottom plan view of my new design.

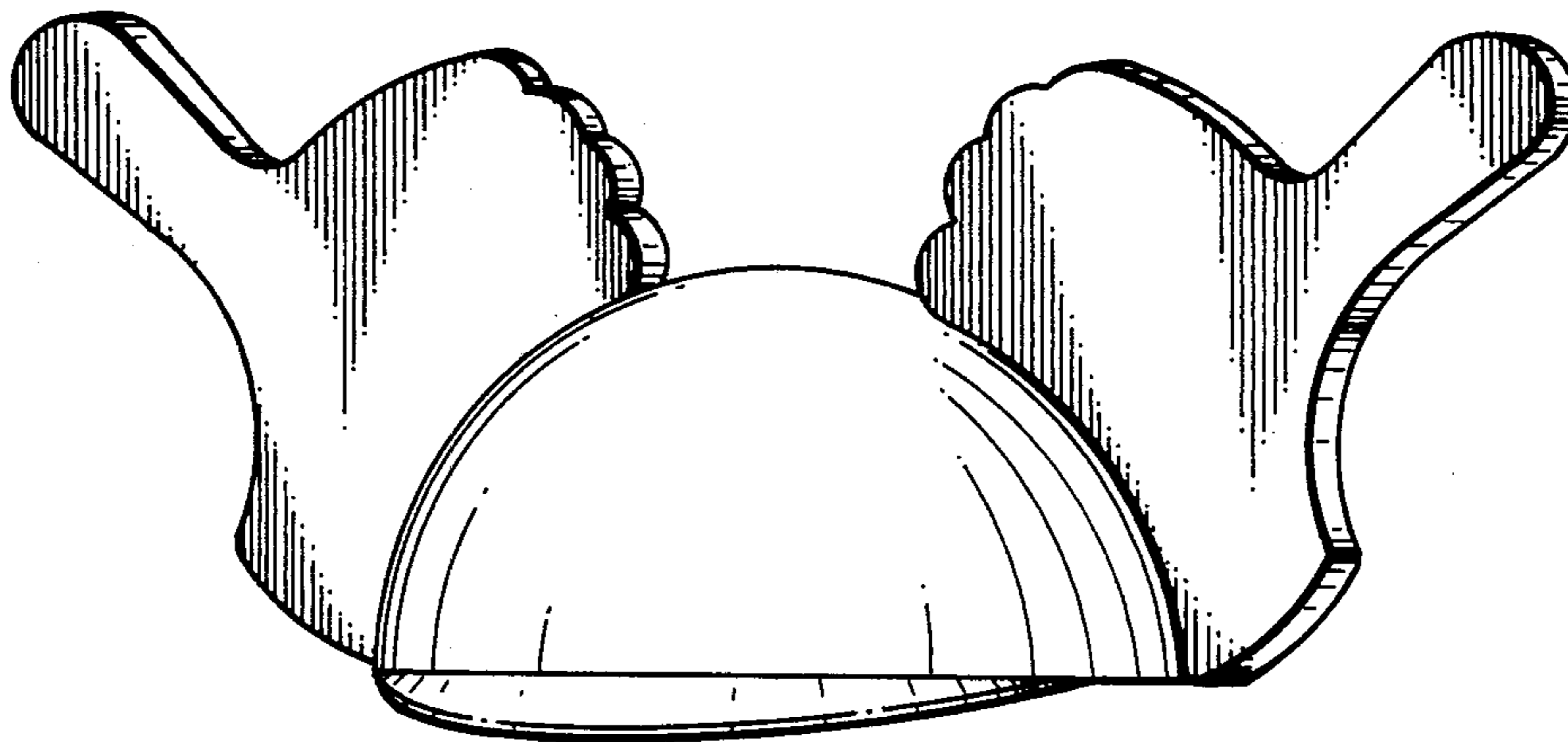

FIG. 1

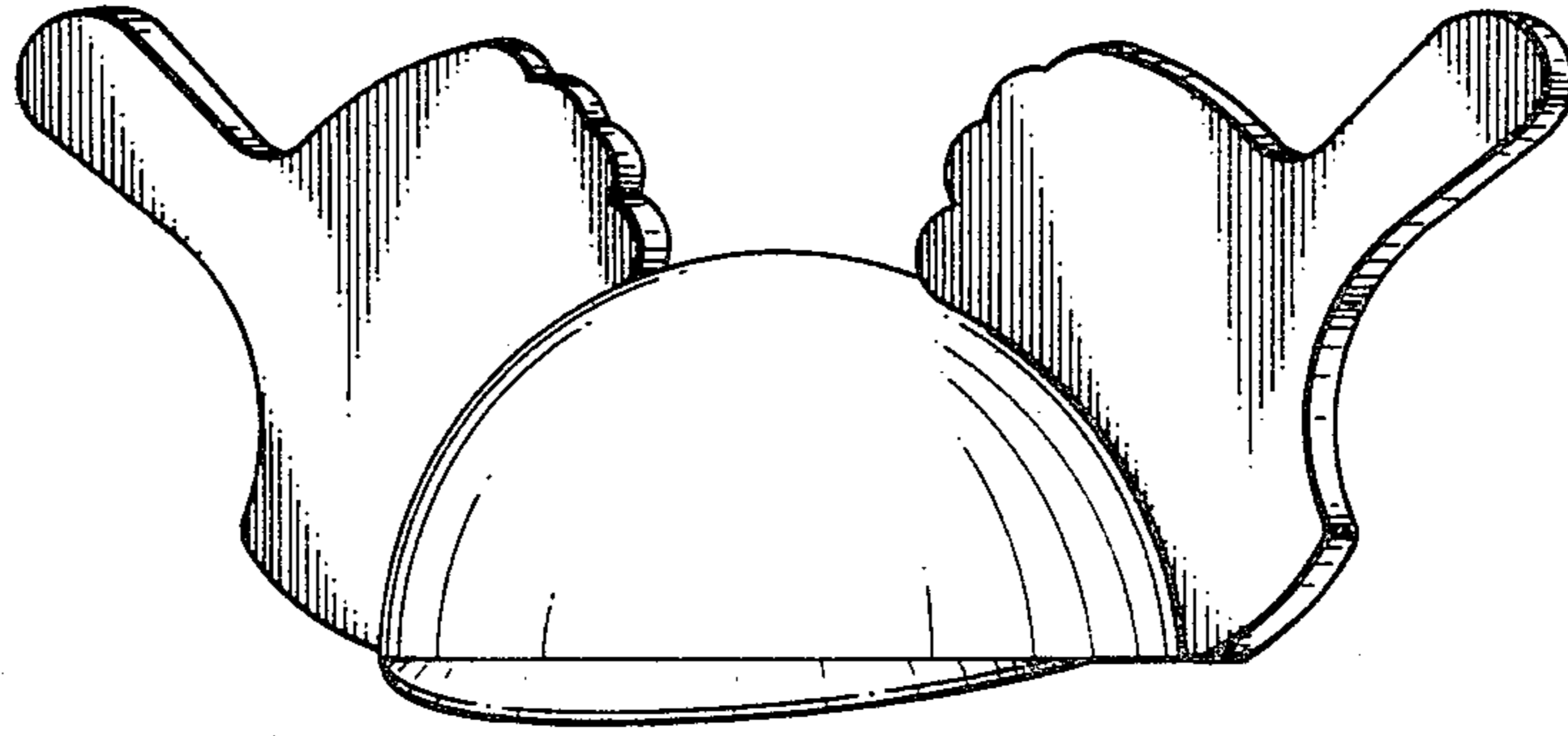

FIG. 2

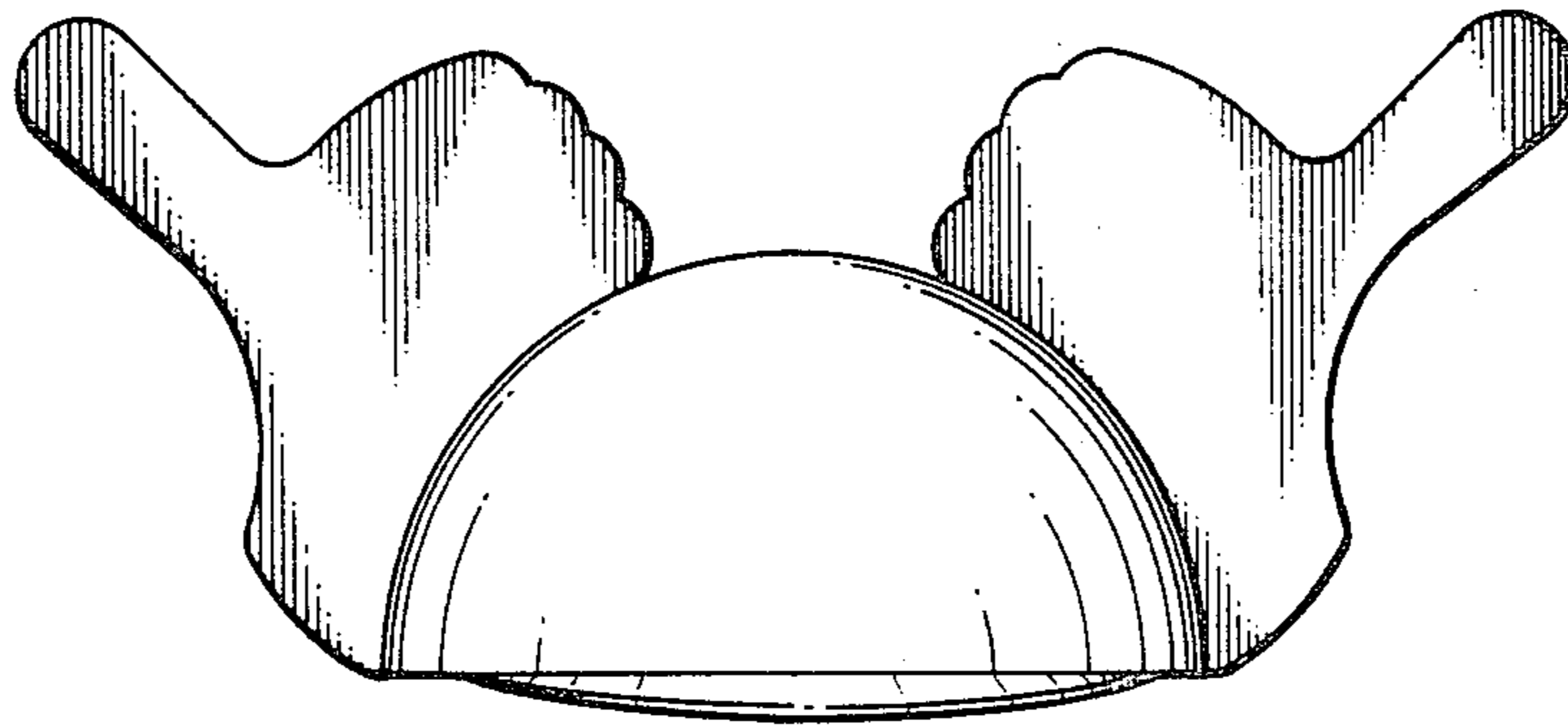

FIG. 3

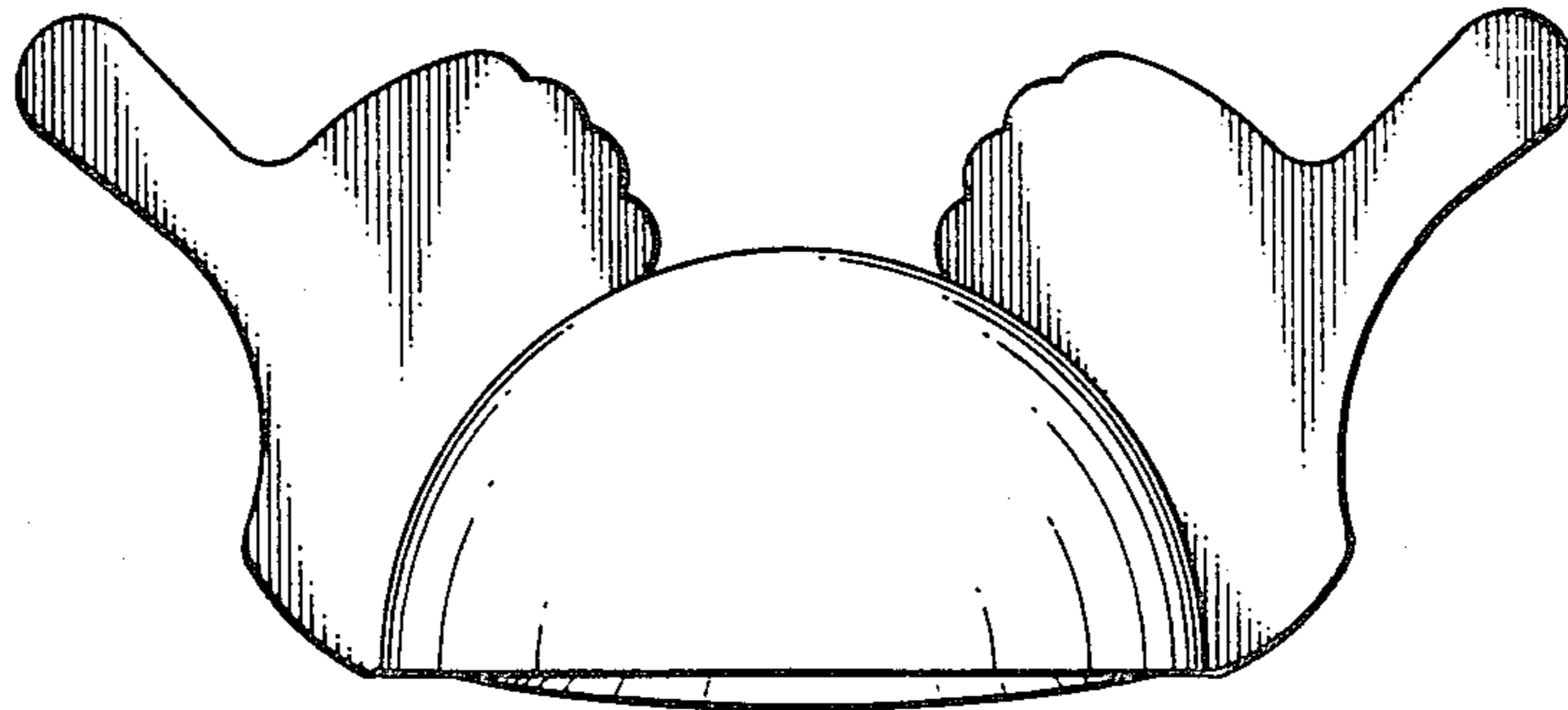

FIG. 4

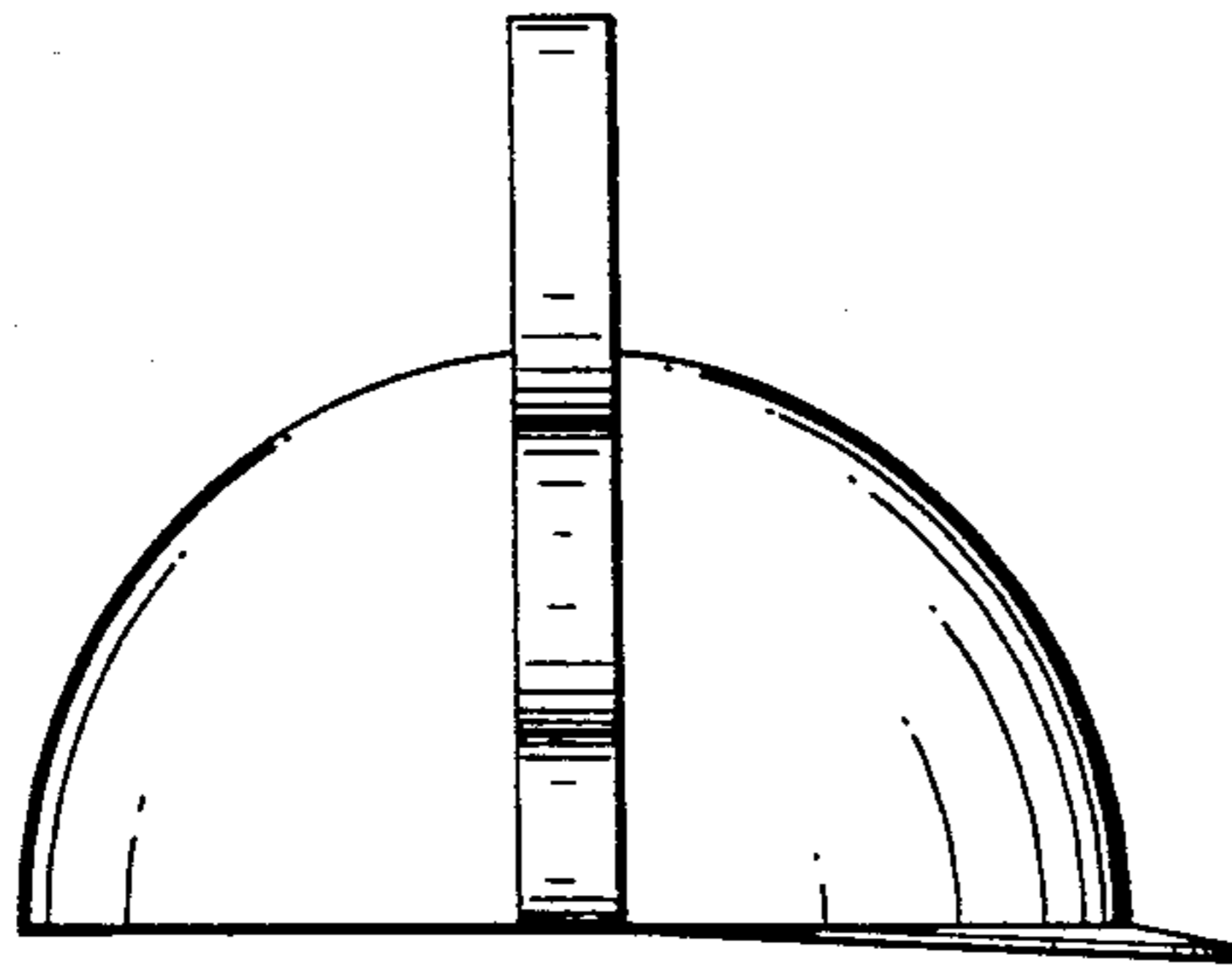

FIG. 5

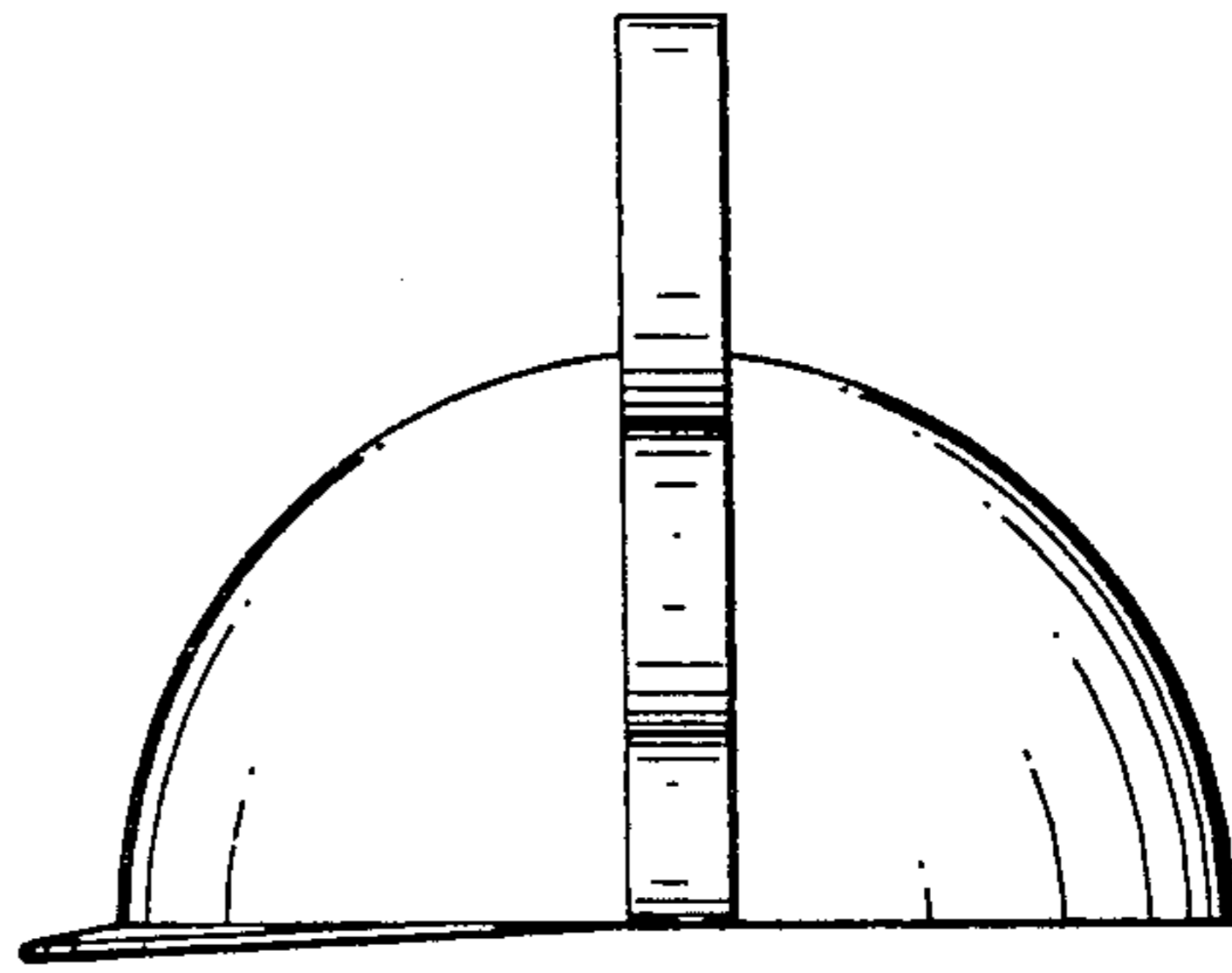

FIG. 6

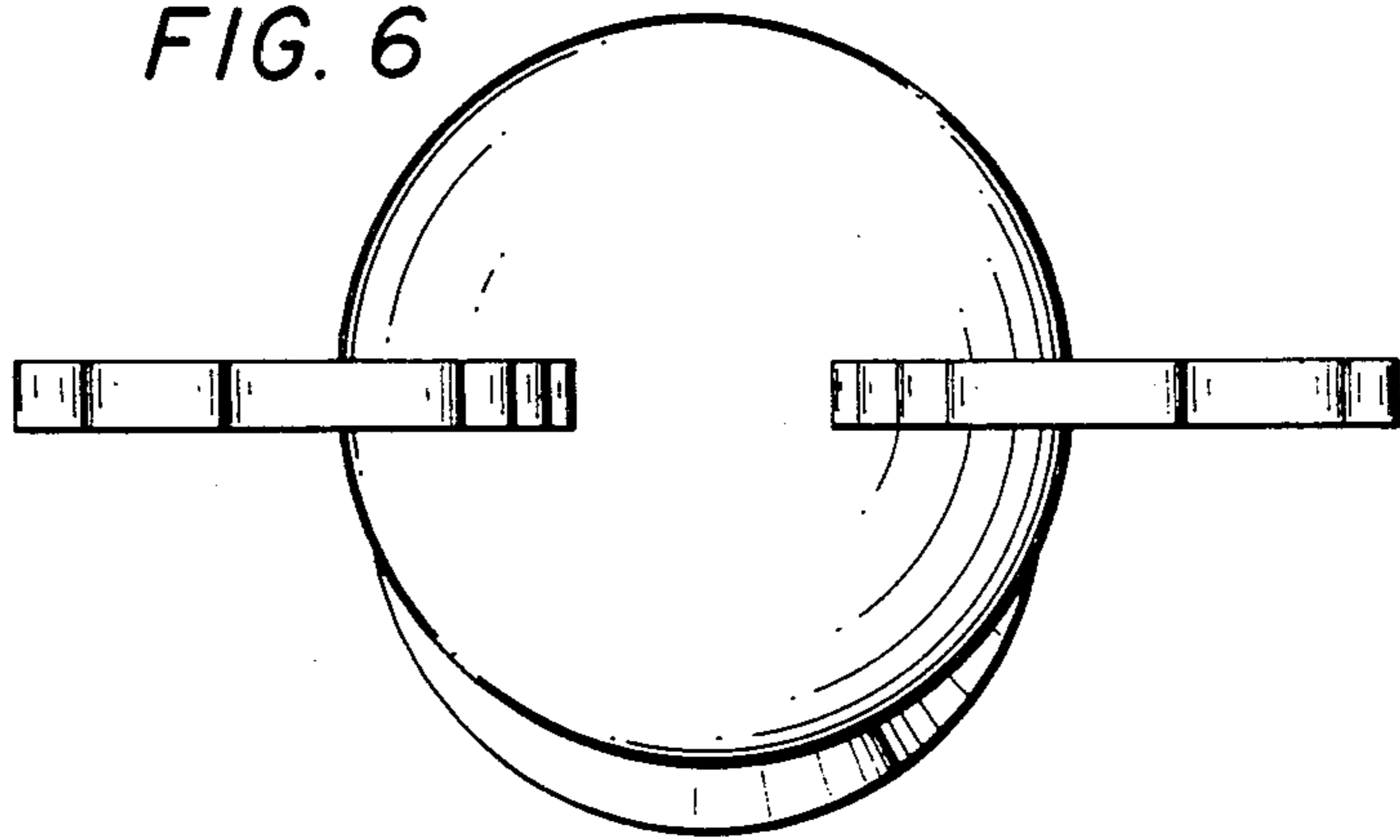

FIG. 7

