

[54] TABLE TOP ELECTRONIC GAME HOUSING

[75] Inventor: Gunpei Yokoi, Kyoto, Japan  
[73] Assignee: Nintendo Co., Ltd., Kyoto, Japan  
[\*\*] Term: 14 Years  
[21] Appl. No.: 511,954  
[22] Filed: Jul. 8, 1983

[30] Foreign Application Priority Data

Feb. 2, 1983 [JP] Japan ..... 58-4010  
[52] U.S. Cl. .... D21/13  
[58] Field of Search ..... D21/13-48;  
273/DIG. 28, 85 G, 148 B, 1 E

[56] References Cited

U.S. PATENT DOCUMENTS

D. 232,951 9/1974 Halliburton ..... D21/13  
3,838,909 10/1974 Fitzgibbons ..... 350/160

OTHER PUBLICATIONS

Playthings, Apr., 1981, p. 49, Galaxy II.  
Playthings, May, 1980, p. 76, Computermatician.  
Playthings, Apr. 1982, p. 17, Coleco Game Housing.

Primary Examiner—Melvin B. Feifer  
Attorney, Agent, or Firm—Christensen, O'Connor,  
Johnson & Kindness

[57] CLAIM

The ornamental design for a table top electronic game housing, as shown.

DESCRIPTION

FIG. 1 is a front elevational view of a table top electronic game housing showing my new design;  
FIG. 2 is a rear elevational view thereof;  
FIG. 3 is a top plan view thereof;  
FIG. 4 is a bottom plan view thereof;  
FIG. 5 is a right side elevational view thereof;  
FIG. 6 is a left side elevational view thereof; and  
FIG. 7 is a cross sectional view thereof taken on line A—A of FIG. 1.

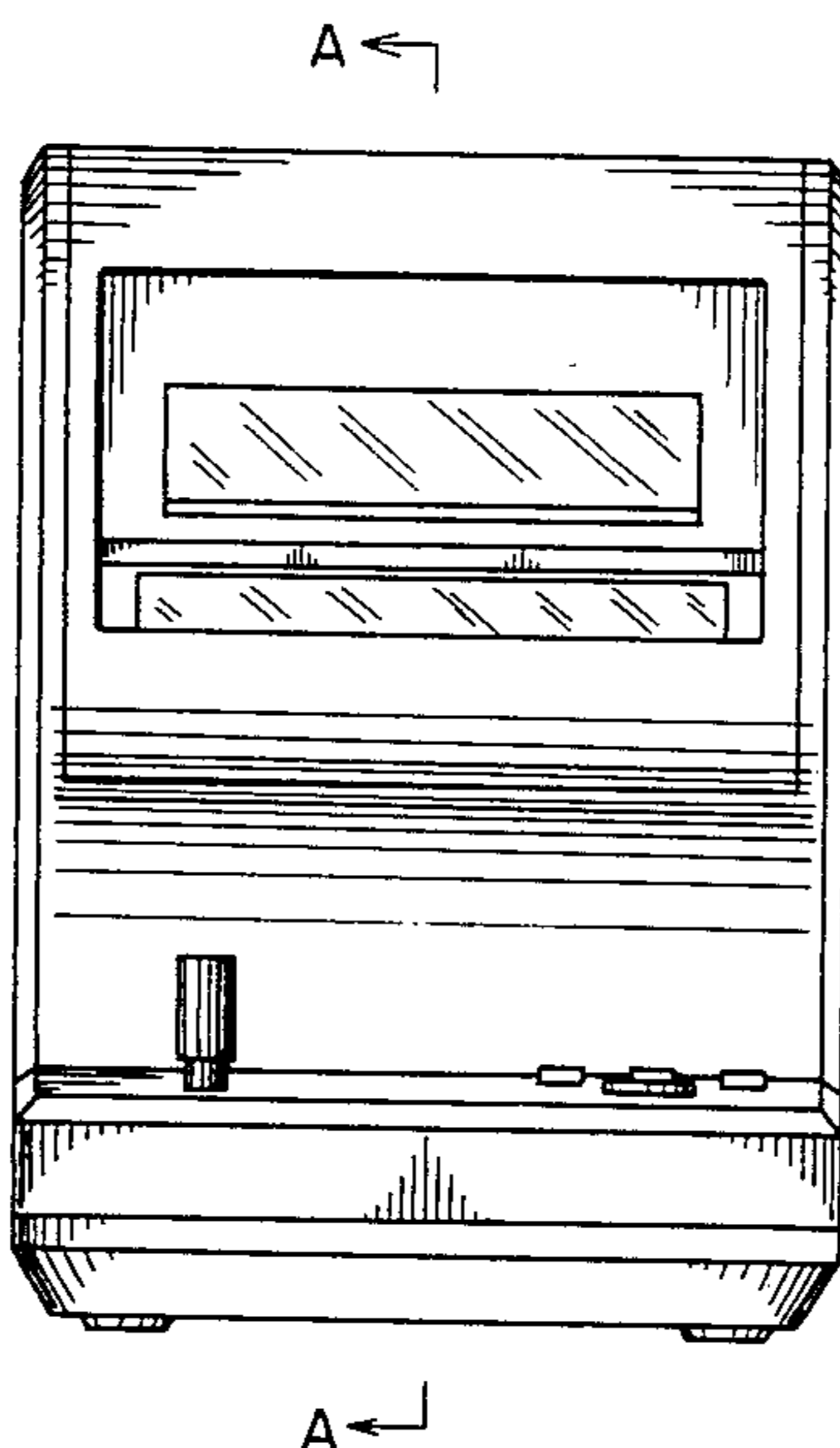

FIG. 1

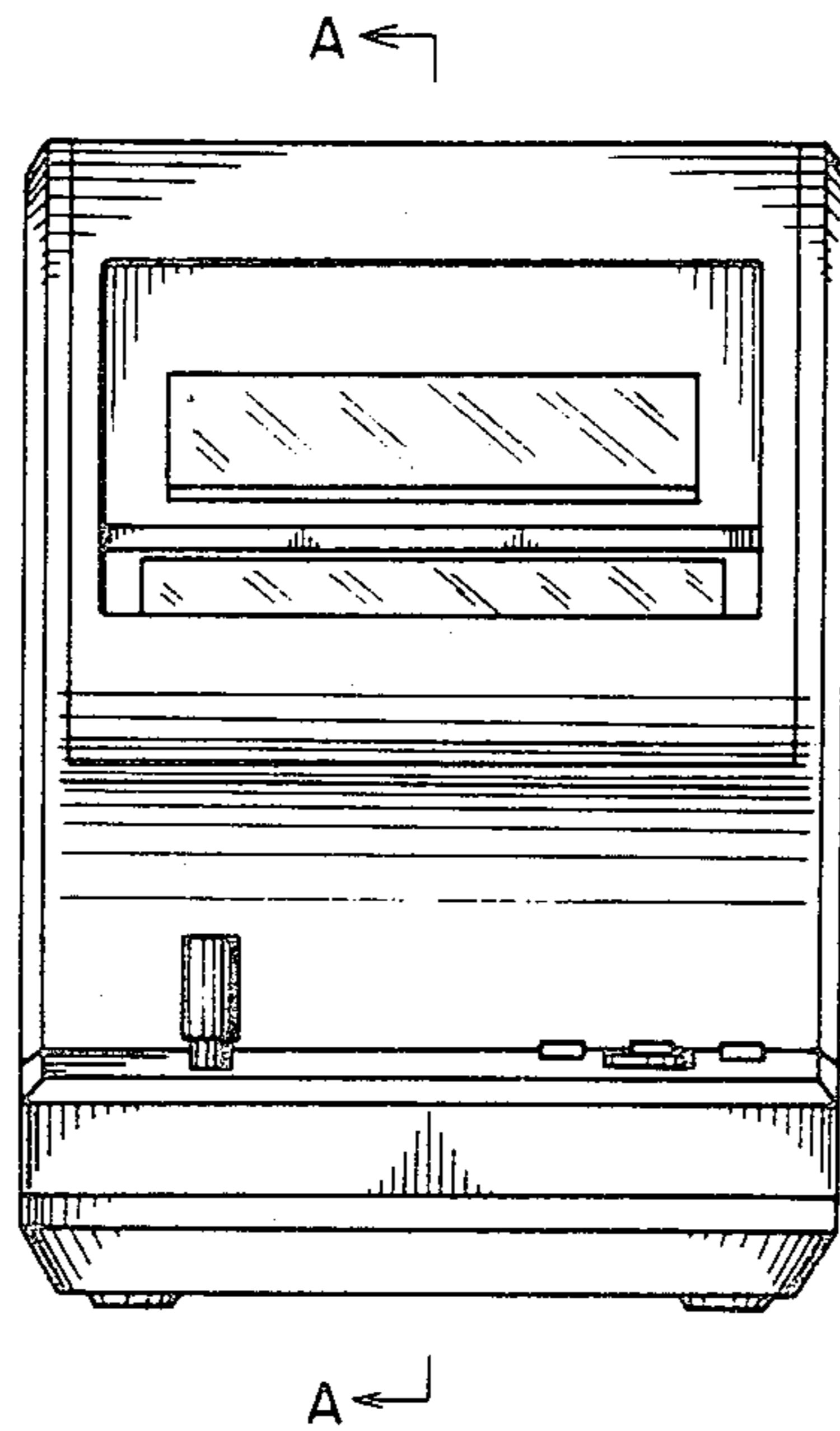

FIG. 2

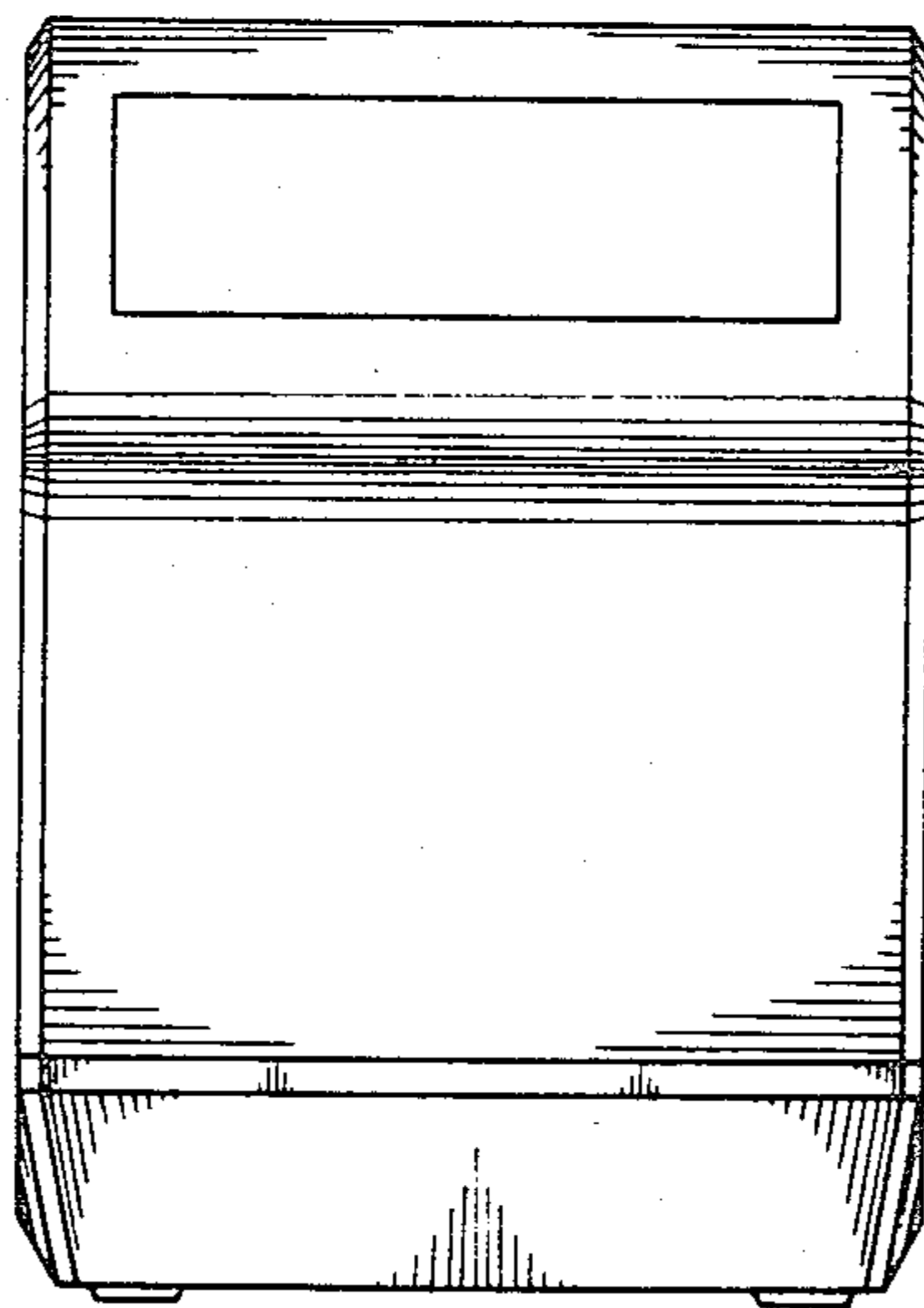

FIG. 3

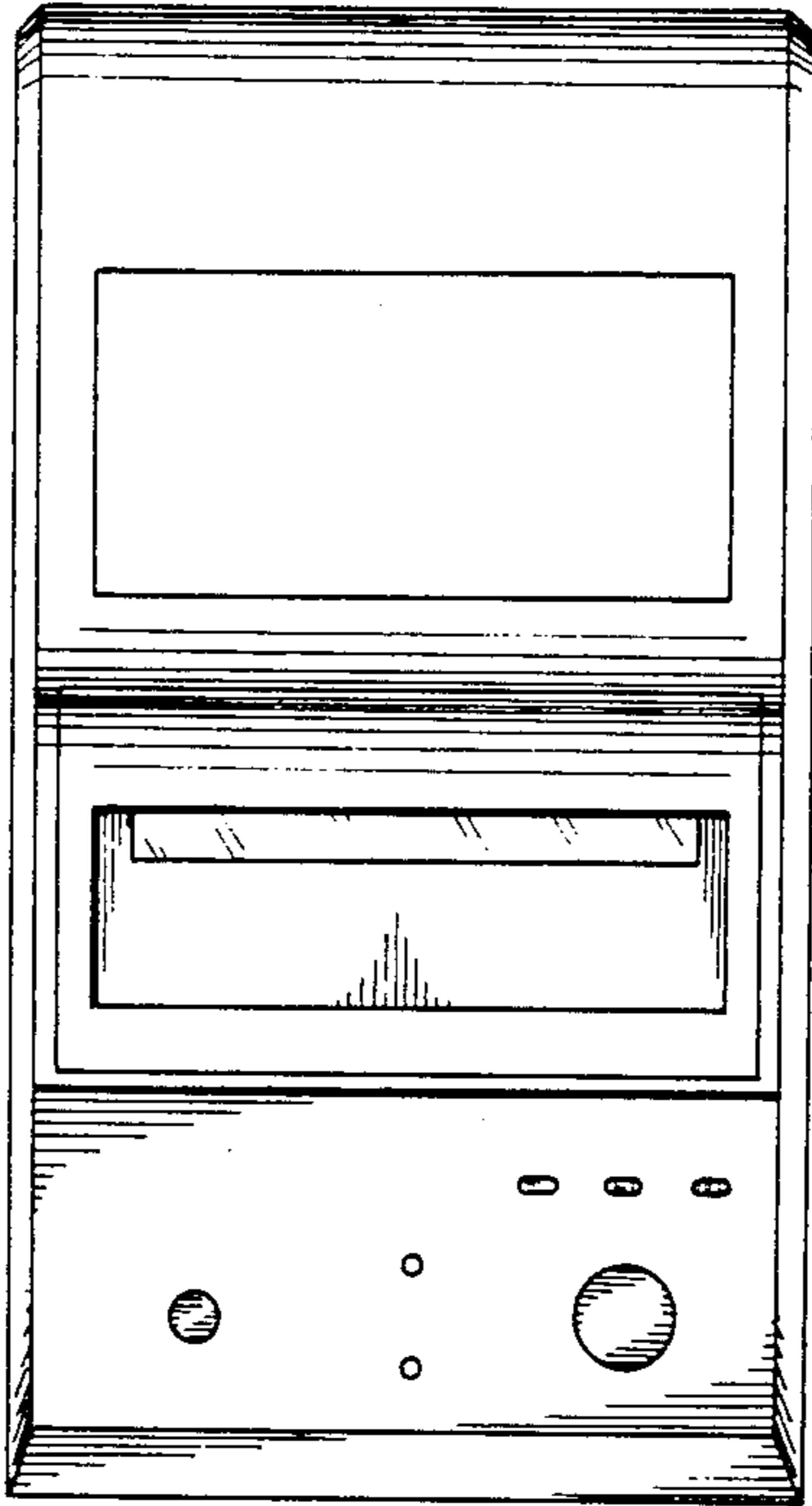

FIG. 4

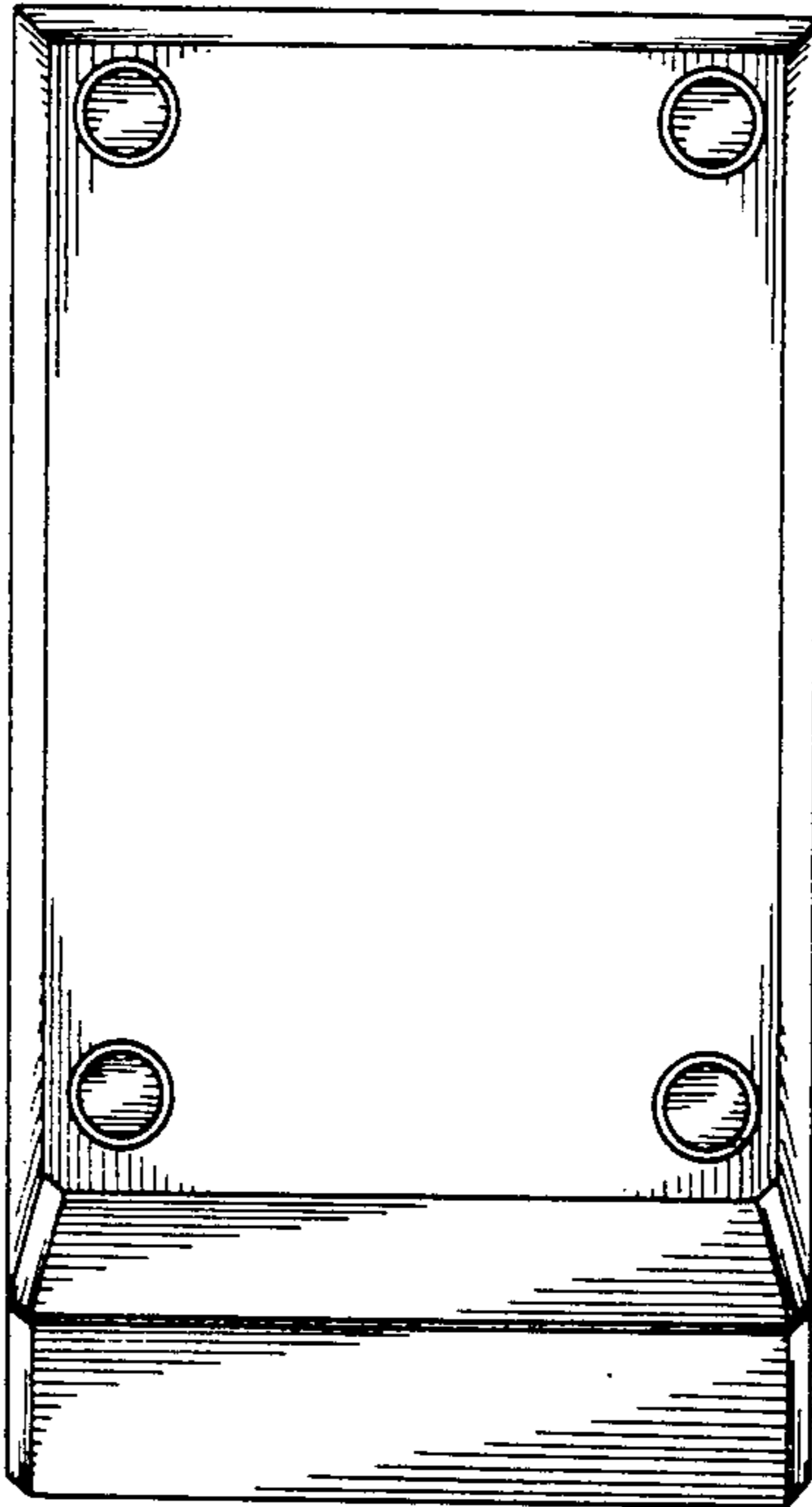

FIG. 5

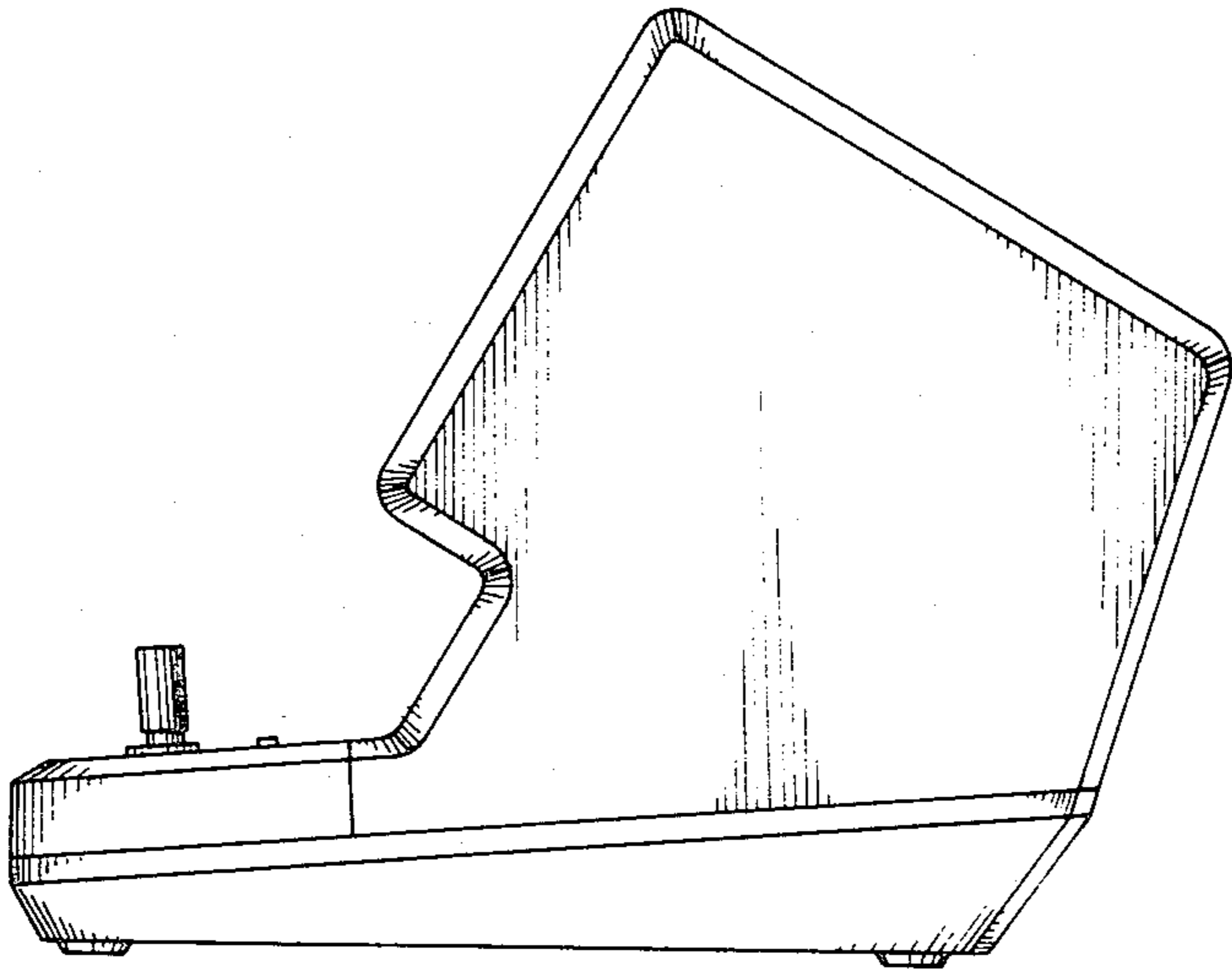

FIG. 6

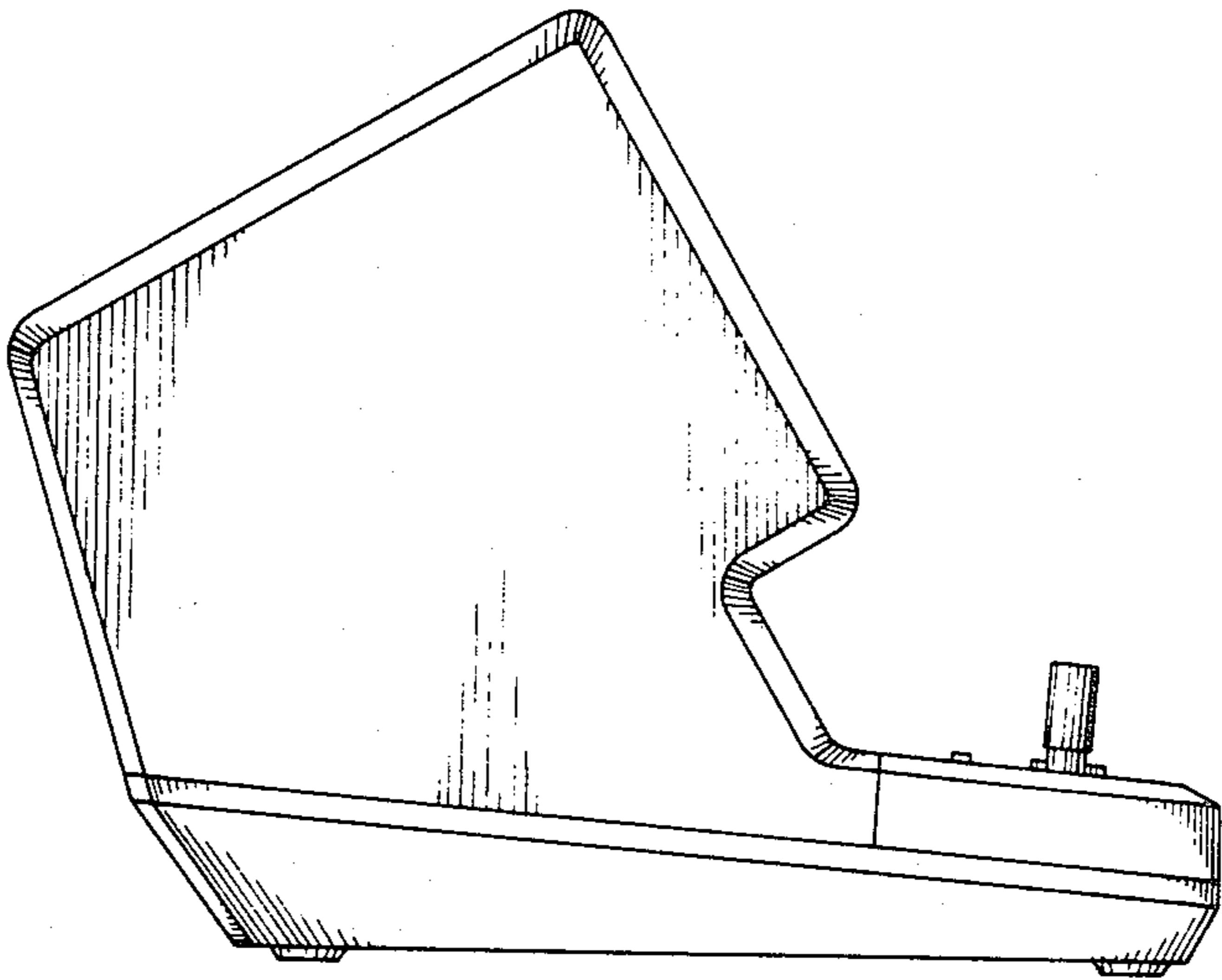

FIG. 7

