

[54] REFRIGERATED DISPLAY CASE FOR FLOWERS OR THE LIKE

[76] Inventor: Hermen Kooy, Stommeerkade 46, 1431 EW Aalsmeer, Netherlands

[\*\*] Term: 14 Years

[21] Appl. No.: 400,412

[22] Filed: Jul. 21, 1982

[52] U.S. Cl. .... D6/471; D34/21

[58] Field of Search ..... D6/182, 181, 186, 187, D6/188, 189, 147, 172, 173, 171; D34/21; 280/47.35, 79.1 A, 79.3; 312/114, 116

[56] References Cited

U.S. PATENT DOCUMENTS

D. 164,779	10/1951	Koenig	.....	D34/21
D. 185,457	6/1959	Molitor	.....	D34/21
D. 197,449	2/1964	Travis	.....	D6/189
D. 202,081	8/1965	Zaslowsky et al.	.....	D6/173
D. 212,568	10/1968	Emery et al.	.....	D6/171
D. 239,677	4/1976	Shaw	.....	D6/182
3,730,603	5/1973	Looms	.....	312/116

Primary Examiner—Carmen H. Vales  
Attorney, Agent, or Firm—Diller, Ramik & Wight

[57] CLAIM

The ornamental design for a refrigerated display case for flowers or the like, substantially as shown and described.

DESCRIPTION

FIG. 1 is a perspective view of the refrigerated display case for flowers or the like showing my new design; FIG. 2 is a left side elevational view thereof, the opposite side being a mirror image thereof; FIG. 3 is a top plan view thereof; FIG. 4 is a front elevational view thereof; FIG. 5 is a rear elevational view thereof; FIG. 6 is a perspective view of the refrigerated display case for flowers or the like showing another embodiment of my new design; FIG. 7 is a left side elevational view thereof, the opposite side being a mirror image thereof; FIG. 8 is a top plan view thereof; FIG. 9 is a front elevational view thereof; and FIG. 10 is a rear elevational view thereof.

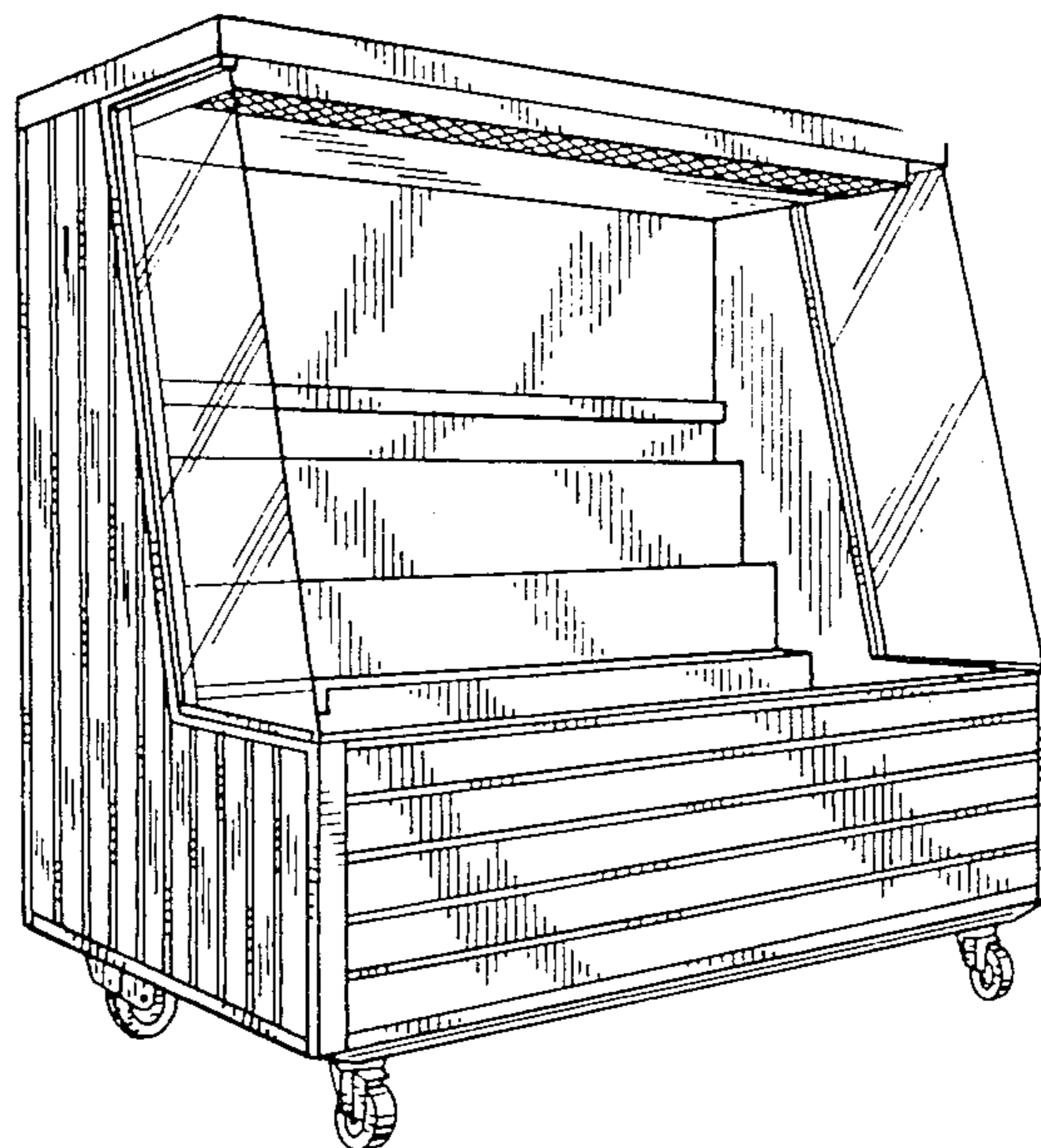
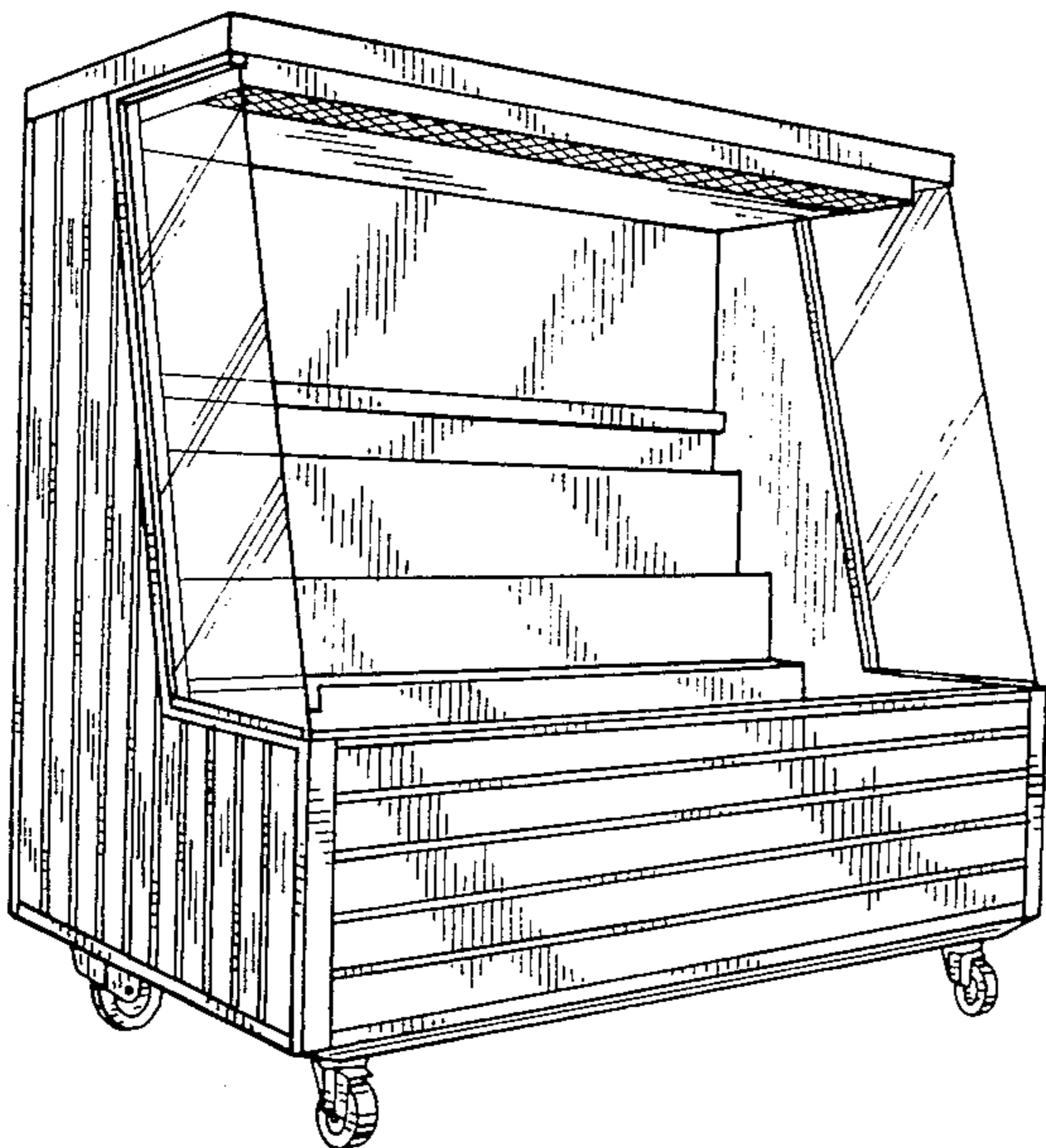

FIG. 3

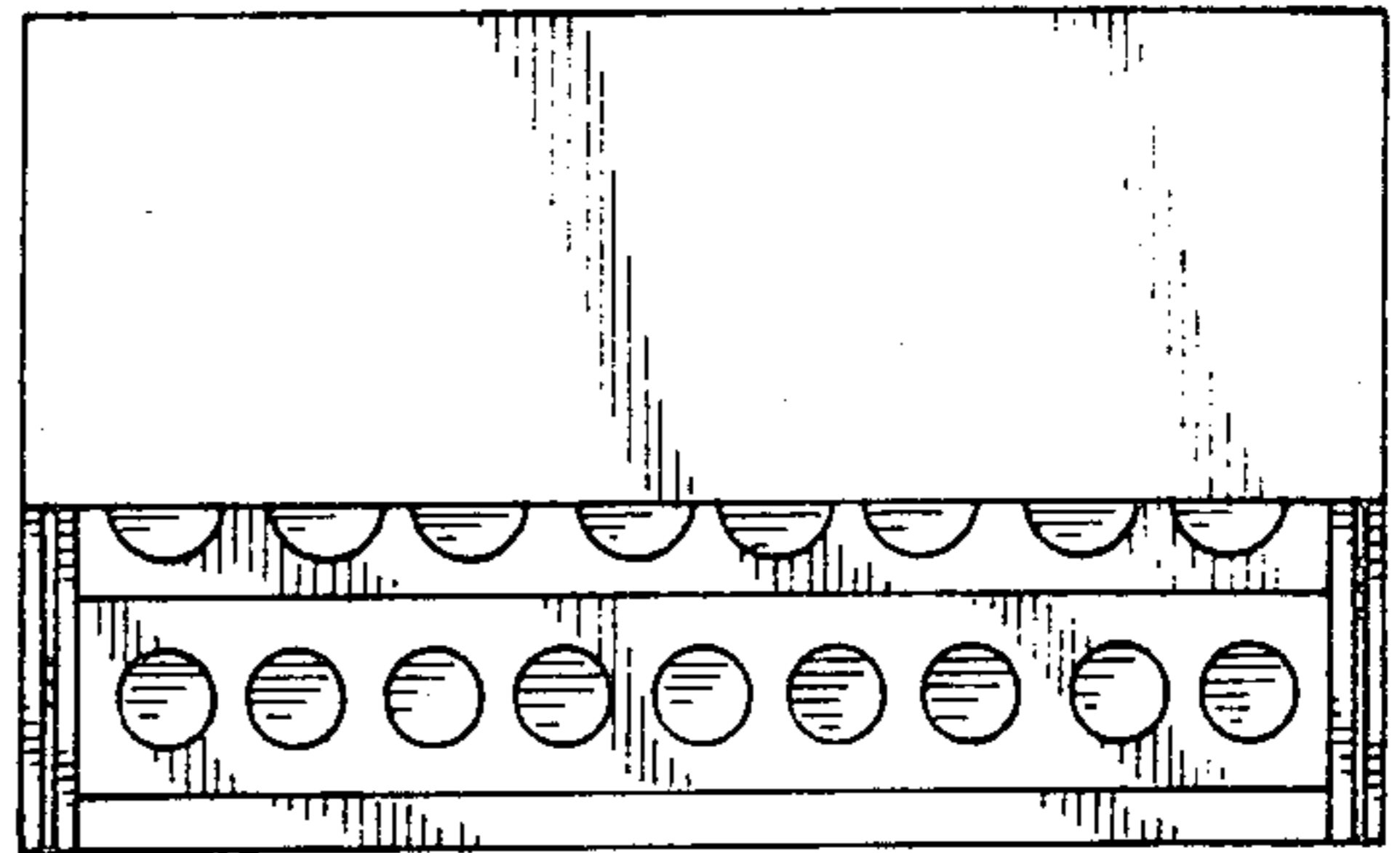

FIG. 2

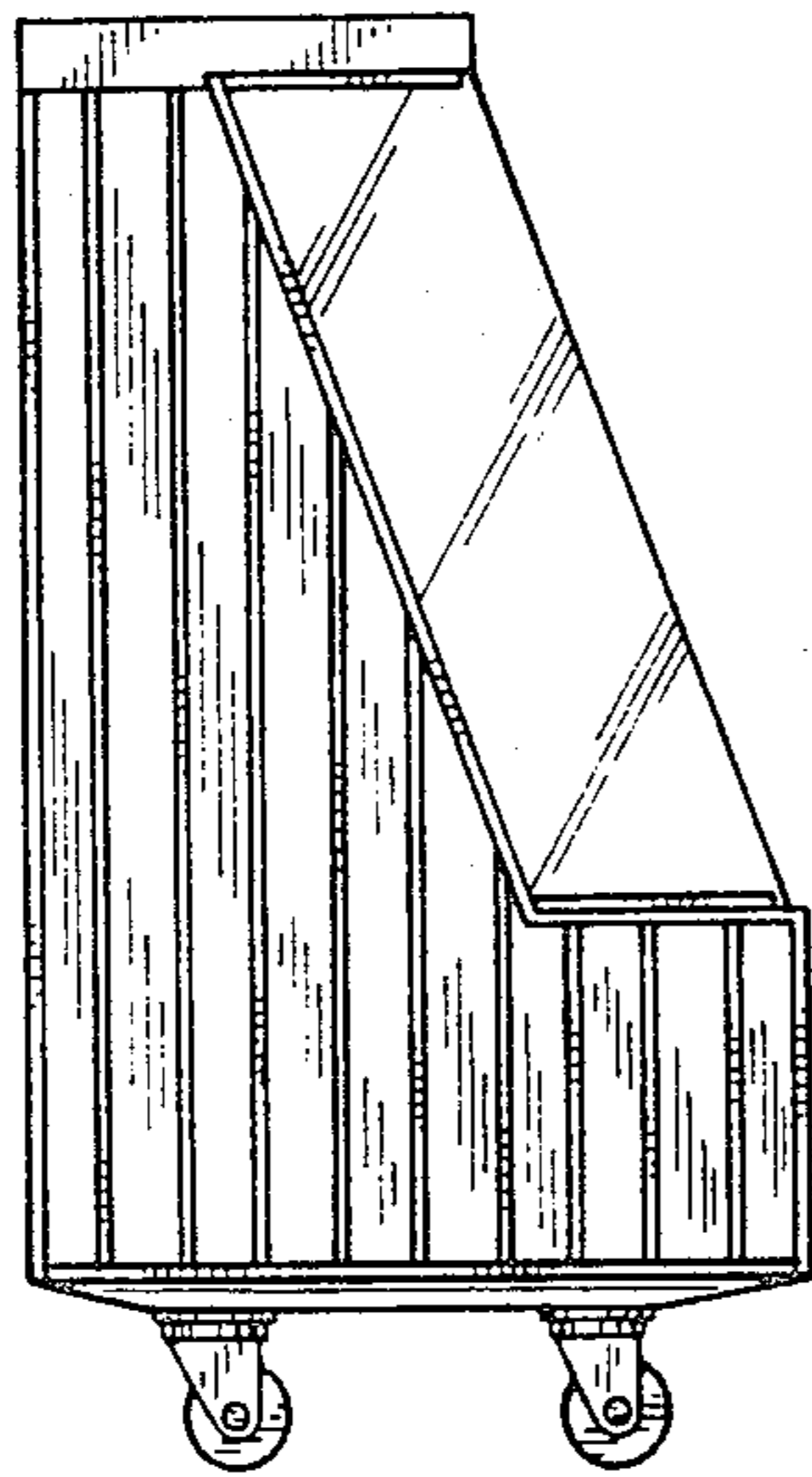

FIG. 4

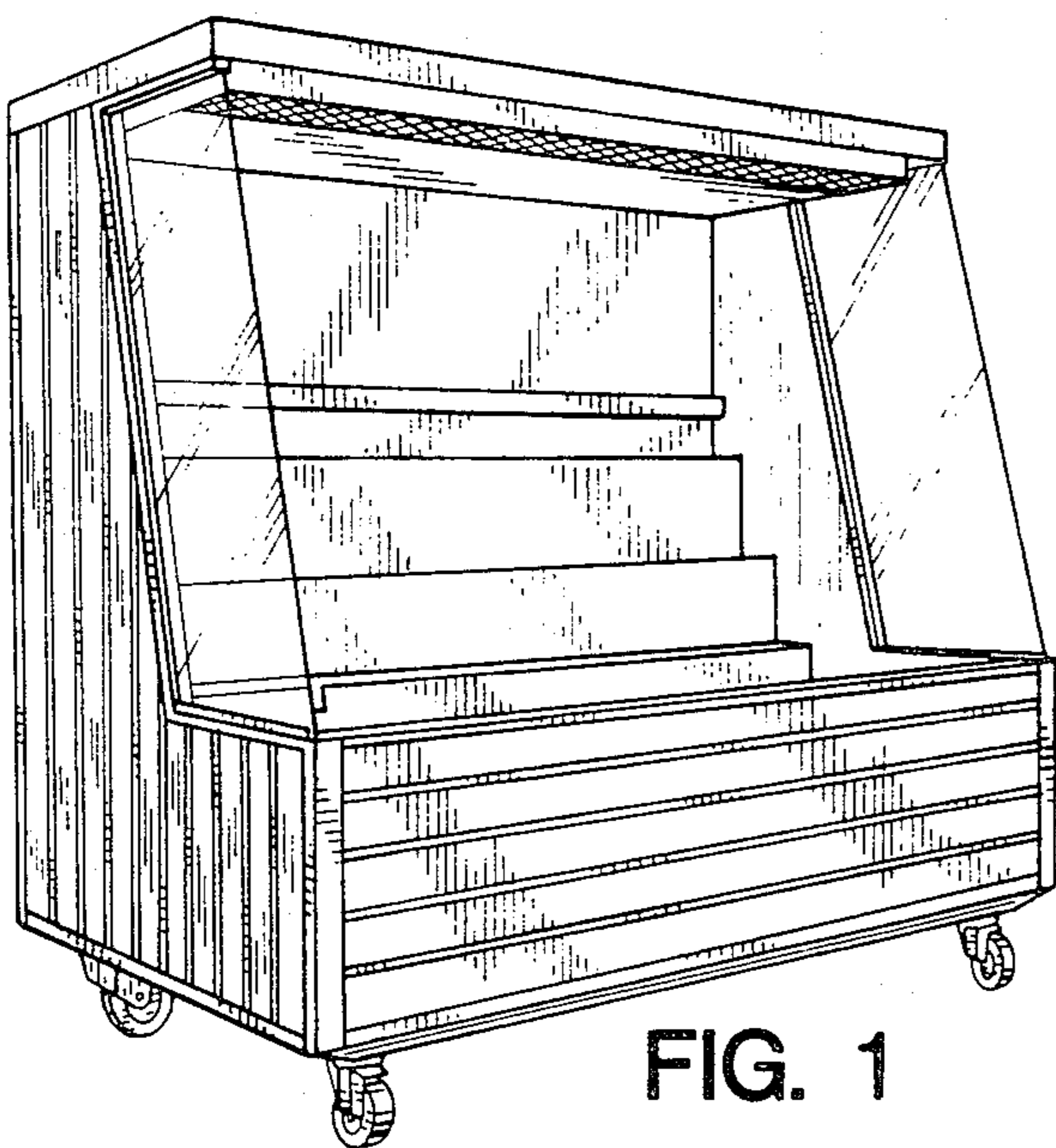
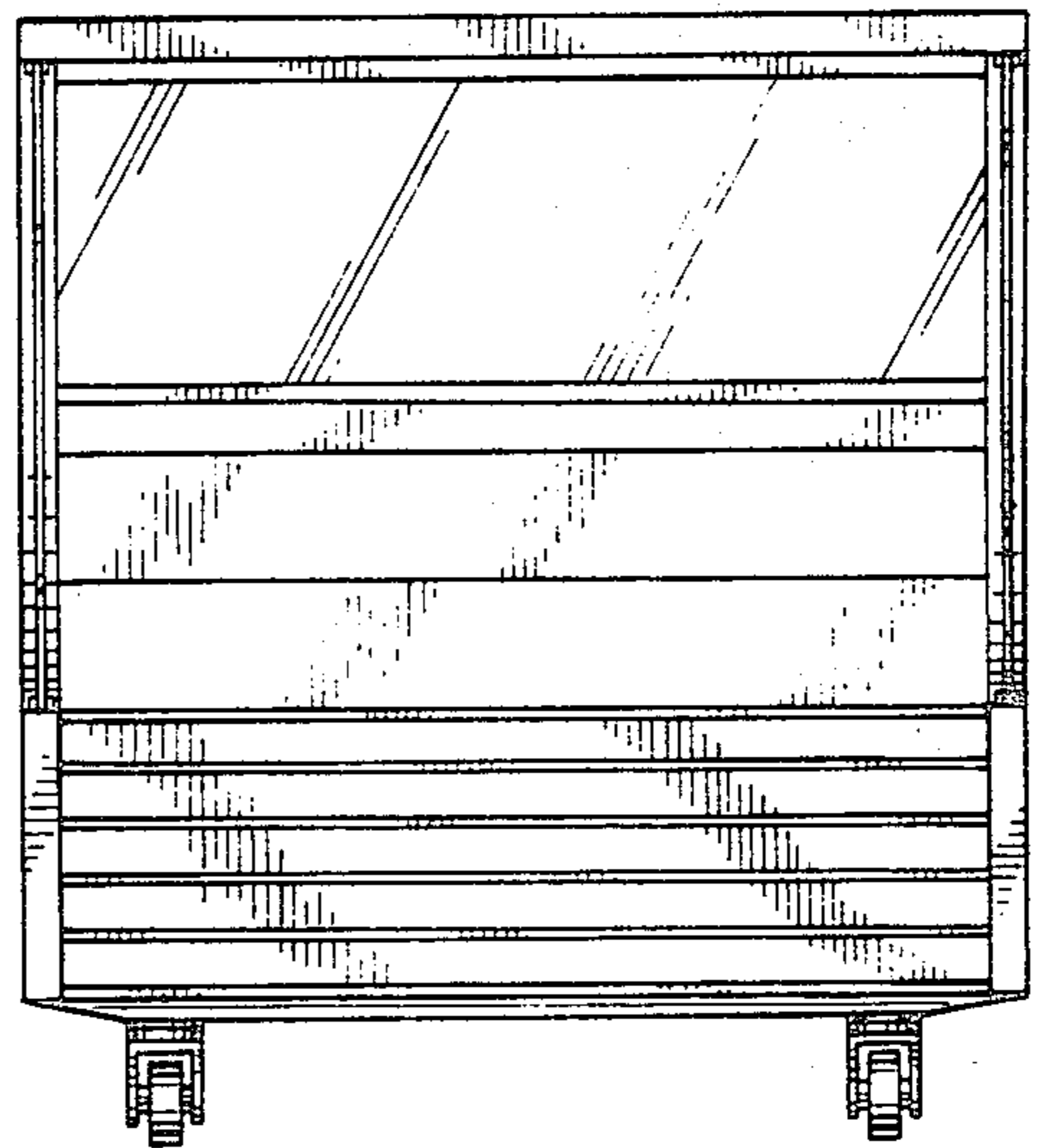

FIG. 1

FIG. 5

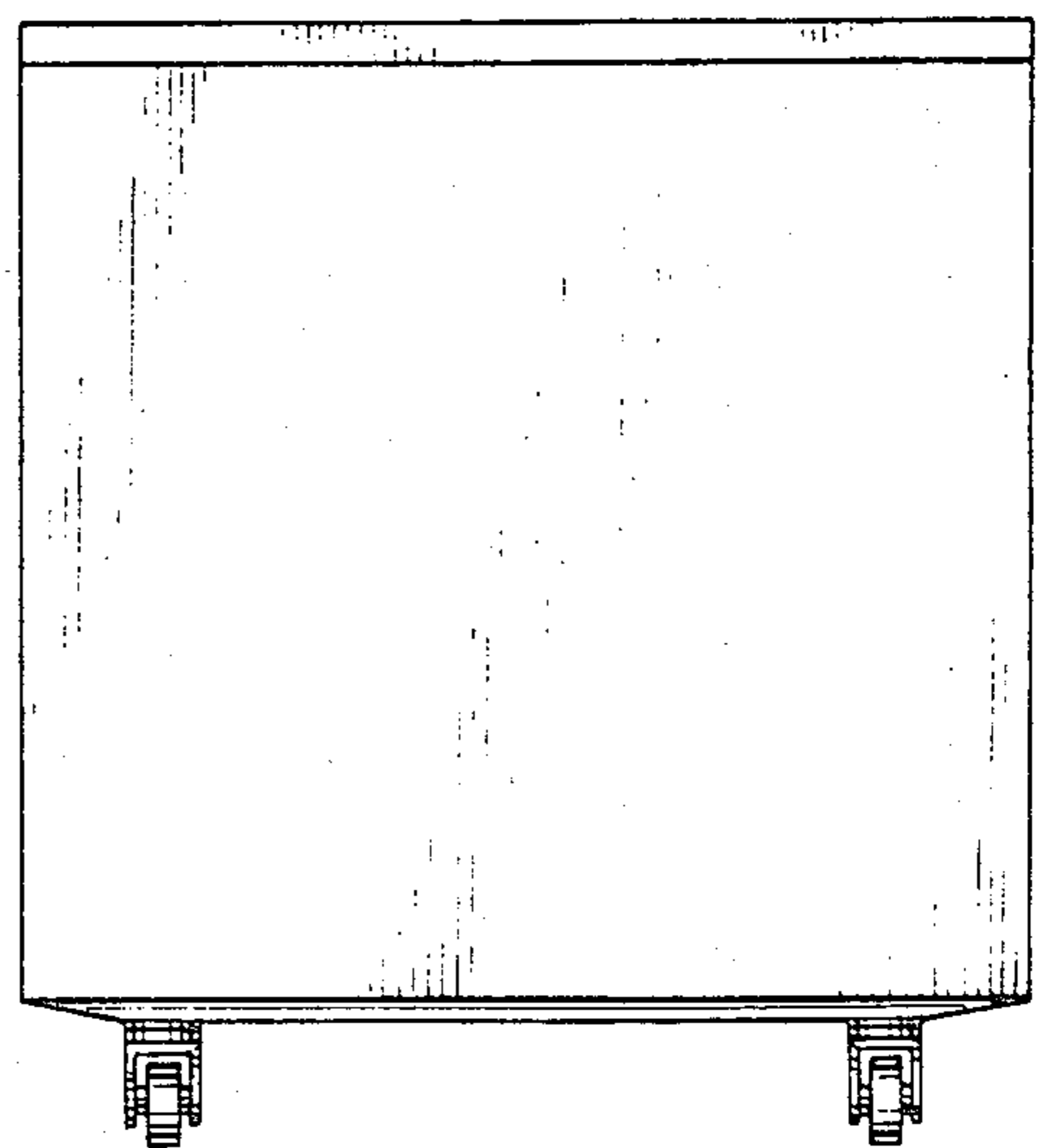

FIG. 8

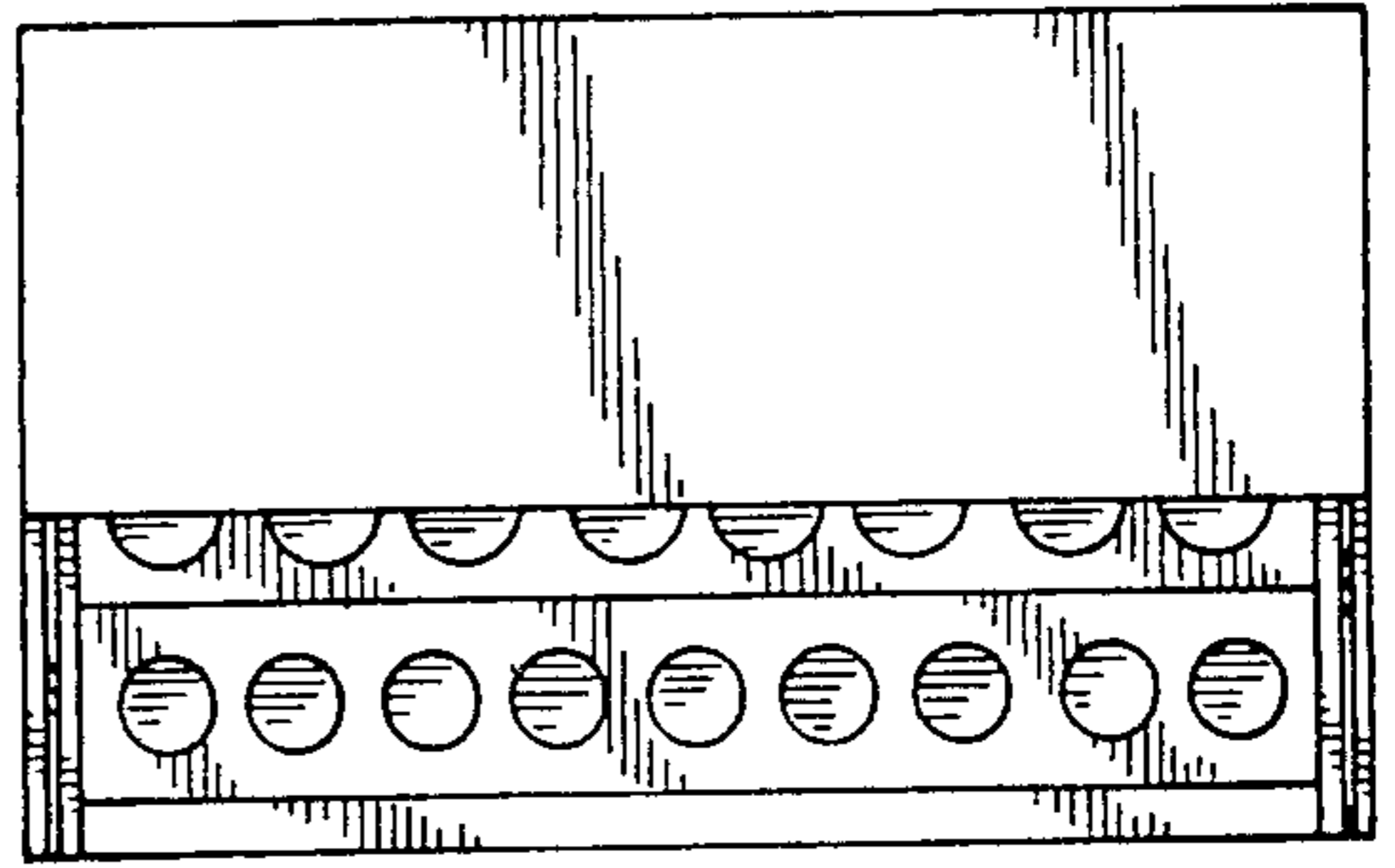

FIG. 7

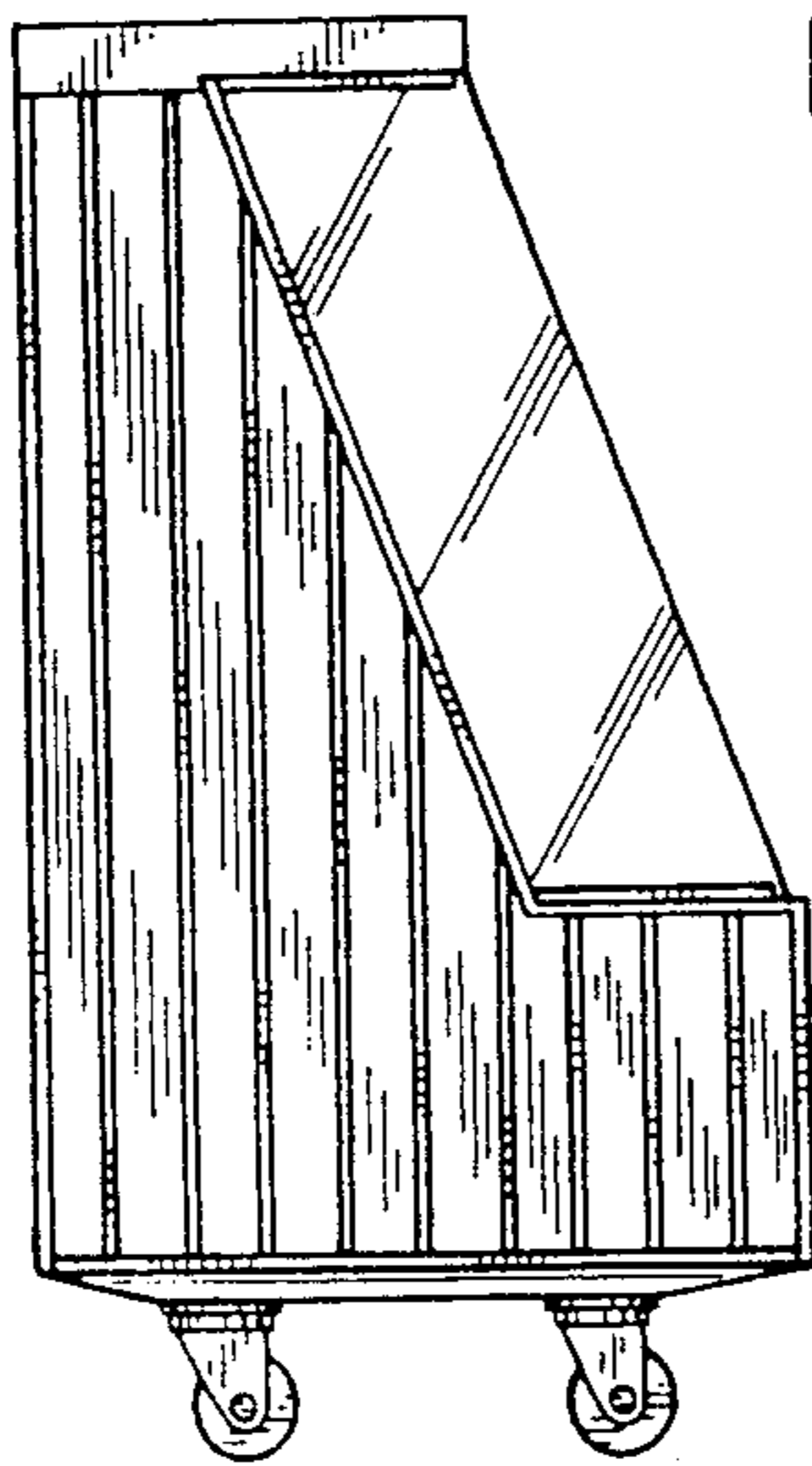

FIG. 9

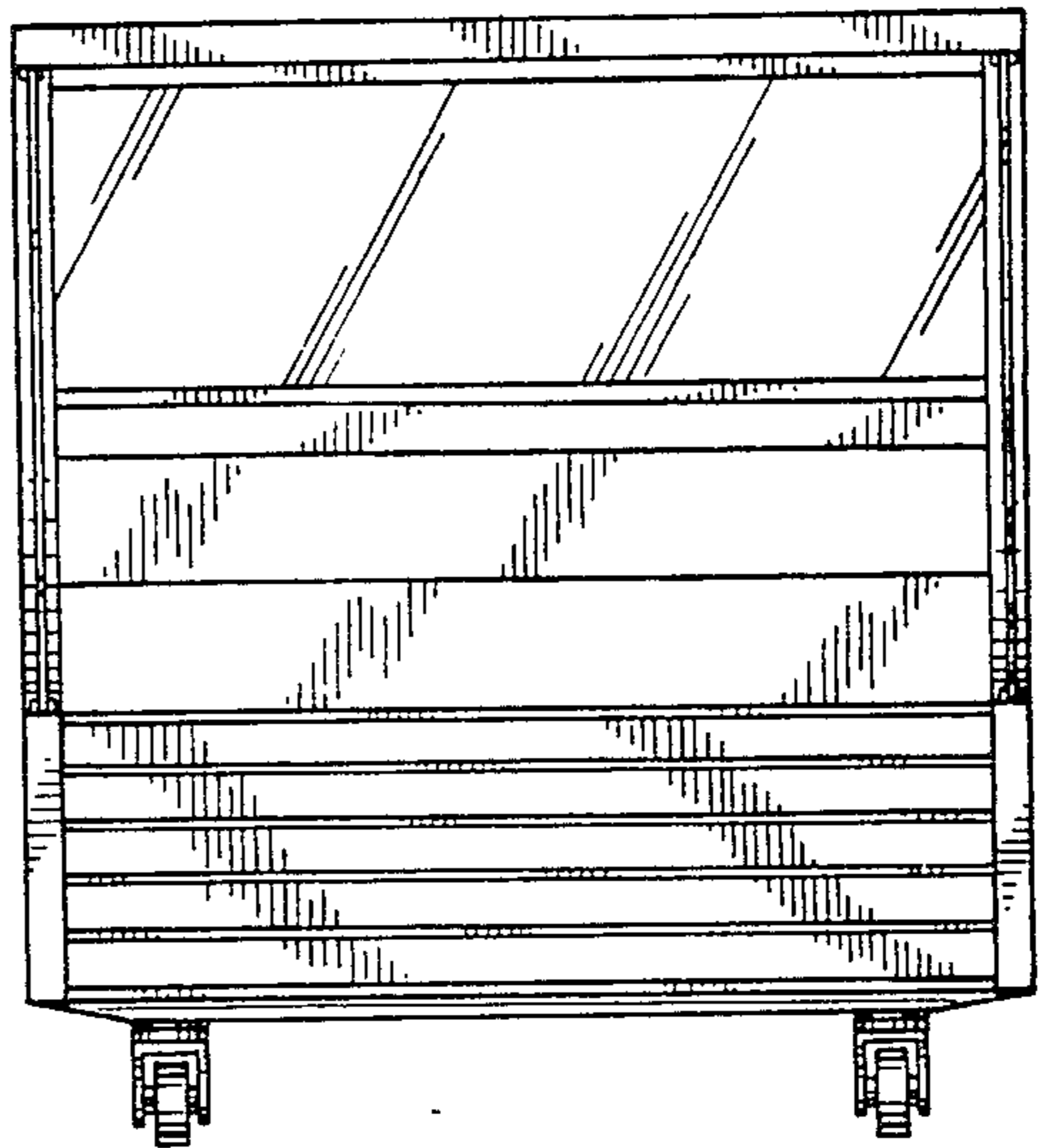

FIG. 6

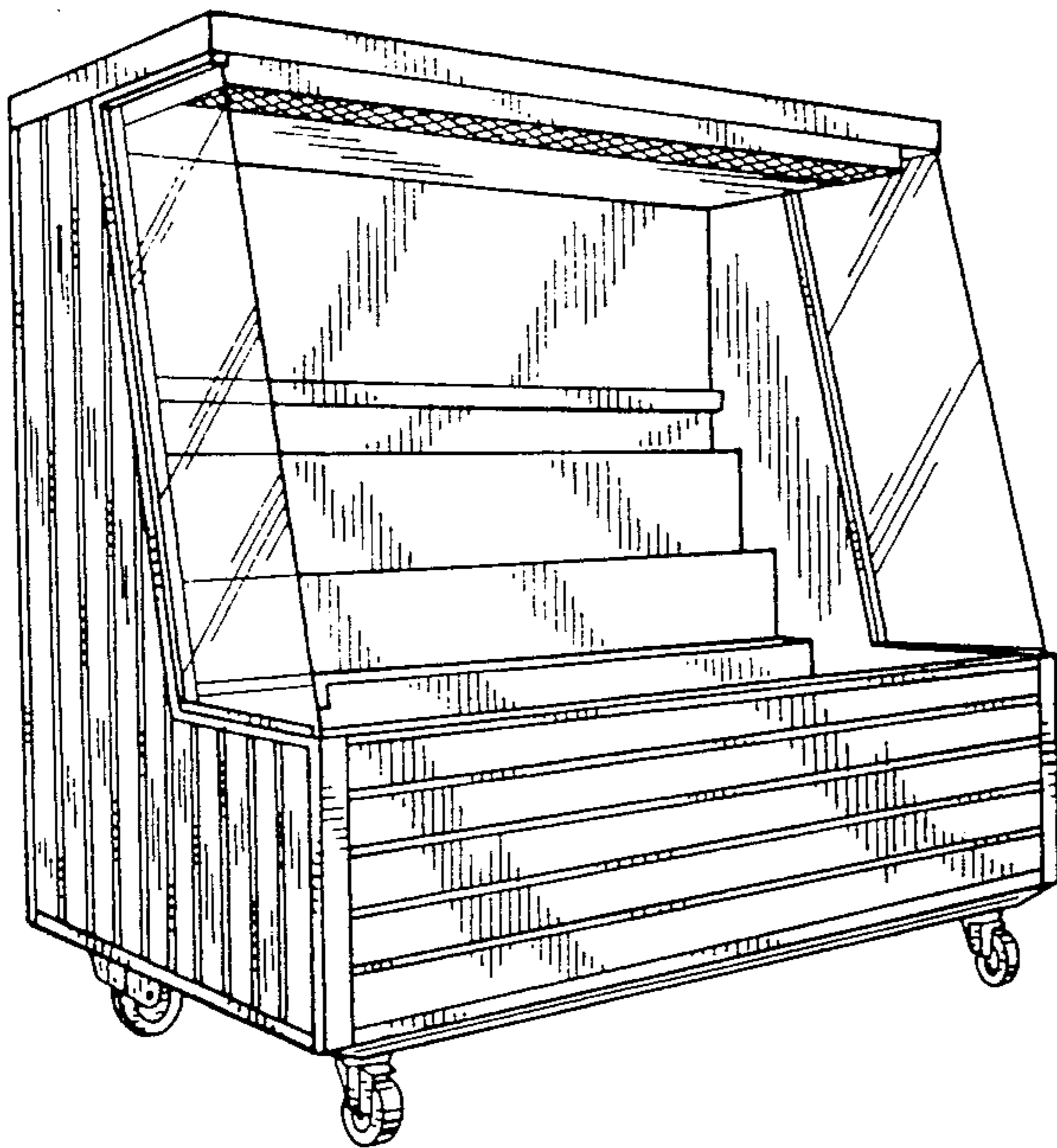
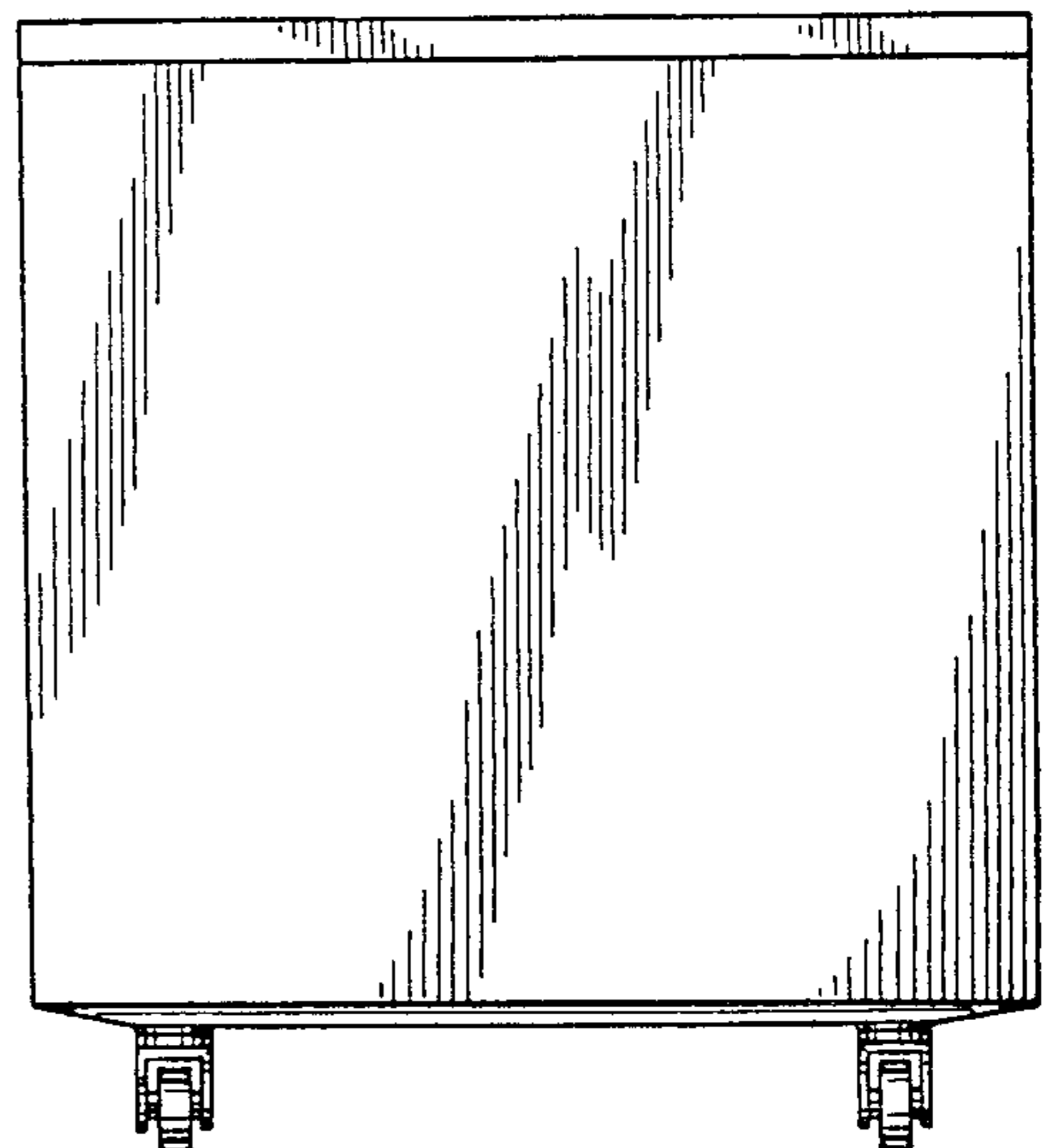

FIG. 10



UNITED STATES PATENT AND TRADEMARK OFFICE  
**CERTIFICATE OF CORRECTION**

PATENT NO. : Des. 280,790

Page 1 of 3

DATED : Oct. 1, 1985

INVENTOR(S) : Hermen Kooy

It is certified that error appears in the above-identified patent and that said Letters Patent is hereby corrected as shown below:

The title page should be deleted to appear as per attached title page.

The sheet of Drawing consisting of Figures 1-5 should be deleted to appear as per attached sheet.

**Signed and Sealed this**  
*Fourteenth Day of January 1986*

[SEAL]

*Attest:*

*Attesting Officer*

**DONALD J. QUIGG**

*Commissioner of Patents and Trademarks*

**United States Patent** [19]  
**Kooy**

[11] **Patent Number: Des. 280,790** .  
[45] **Date of Patent: \*\* Oct. 1, 1985**

- [54] **REFRIGERATED DISPLAY CASE FOR FLOWERS OR THE LIKE**
- [76] **Inventor: Hermen Kooy, Stommeerkade 46, 1431 EW Aalsmeer, Netherlands**
- [\*\*] **Term: 14 Years**
- [21] **Appl. No.: 400,412**
- [22] **Filed: Jul. 21, 1982**
- [52] **U.S. Cl. .... D6/471; D34/21**
- [58] **Field of Search .... D6/182, 181, 186, 187, D6/188, 189, 147, 172, 173, 171; D34/21; 280/47.35, 79.1 A, 79.3; 312/114, 116**

[56] **References Cited**

**U.S. PATENT DOCUMENTS**

D. 164,779	10/1951	Koenig	.....	D34/21
D. 185,457	6/1959	Molitor	.....	D34/21
D. 197,449	2/1964	Travis	.....	D6/189
D. 202,081	8/1965	Zaslowsky et al.	.....	D6/173
D. 212,568	10/1968	Emery et al.	.....	D6/171
D. 239,677	4/1976	Shaw	.....	D6/182
3,730,603	5/1973	Looms	.....	312/116

*Primary Examiner*—Carmen H. Vales  
*Attorney, Agent, or Firm*—Diller, Ramik & Wight

[57] **CLAIM**  
The ornamental design for a refrigerated display case for flowers or the like, substantially as shown and described.

**DESCRIPTION**

FIG. 1 is a perspective view of the refrigerated display case for flowers or the like showing my new design; FIG. 2 is a left side elevational view thereof, the opposite side being a mirror image thereof; FIG. 3 is a top plan view thereof; FIG. 4 is a front elevational view thereof; FIG. 5 is a rear elevational view thereof; FIG. 6 is a perspective view of the refrigerated display case for flowers or the like showing another embodiment of my new design; FIG. 7 is a left side elevational view thereof, the opposite side being a mirror image thereof; FIG. 8 is a top plan view thereof; FIG. 9 is a front elevational view thereof; and FIG. 10 is a rear elevational view thereof.

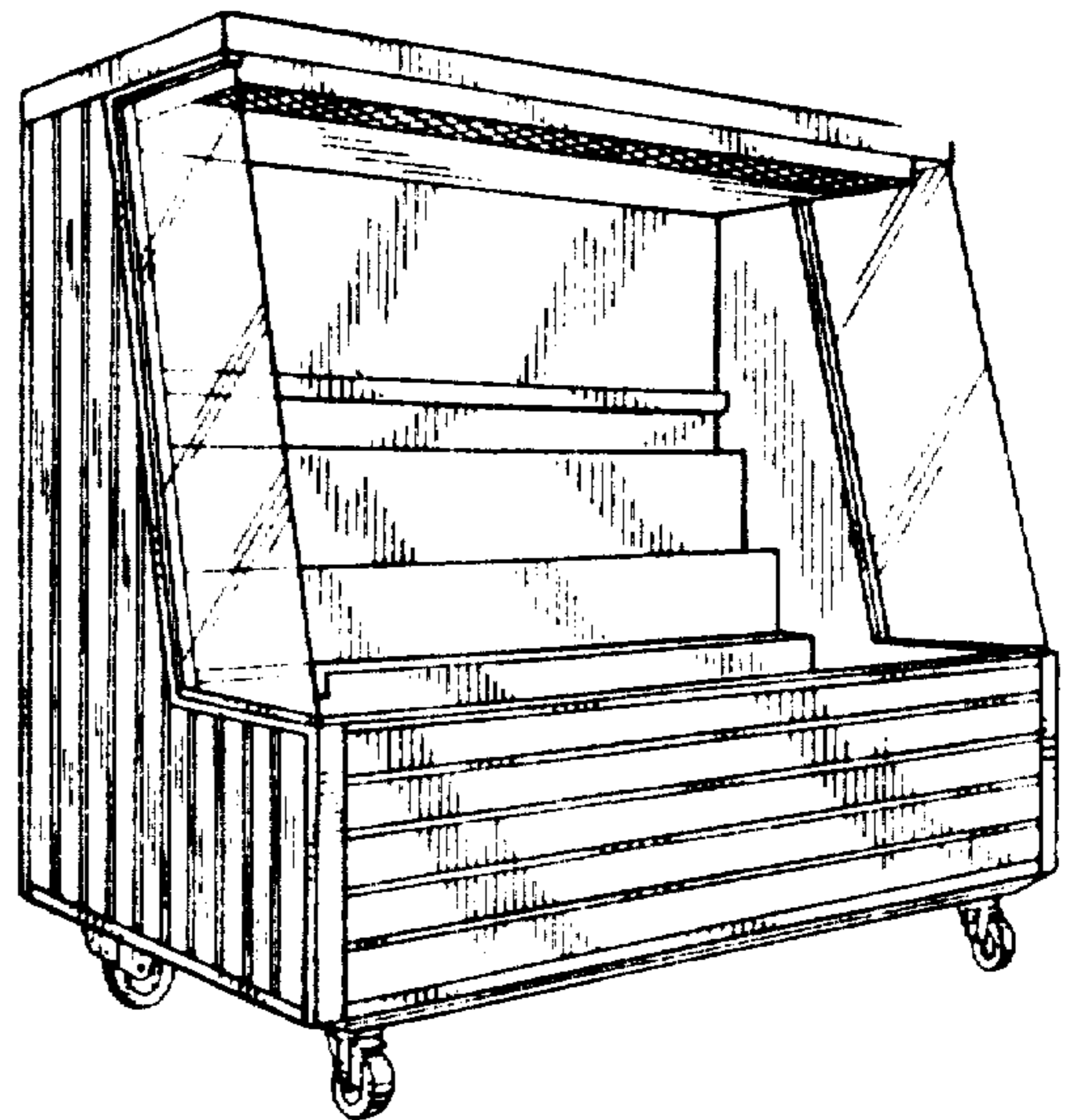
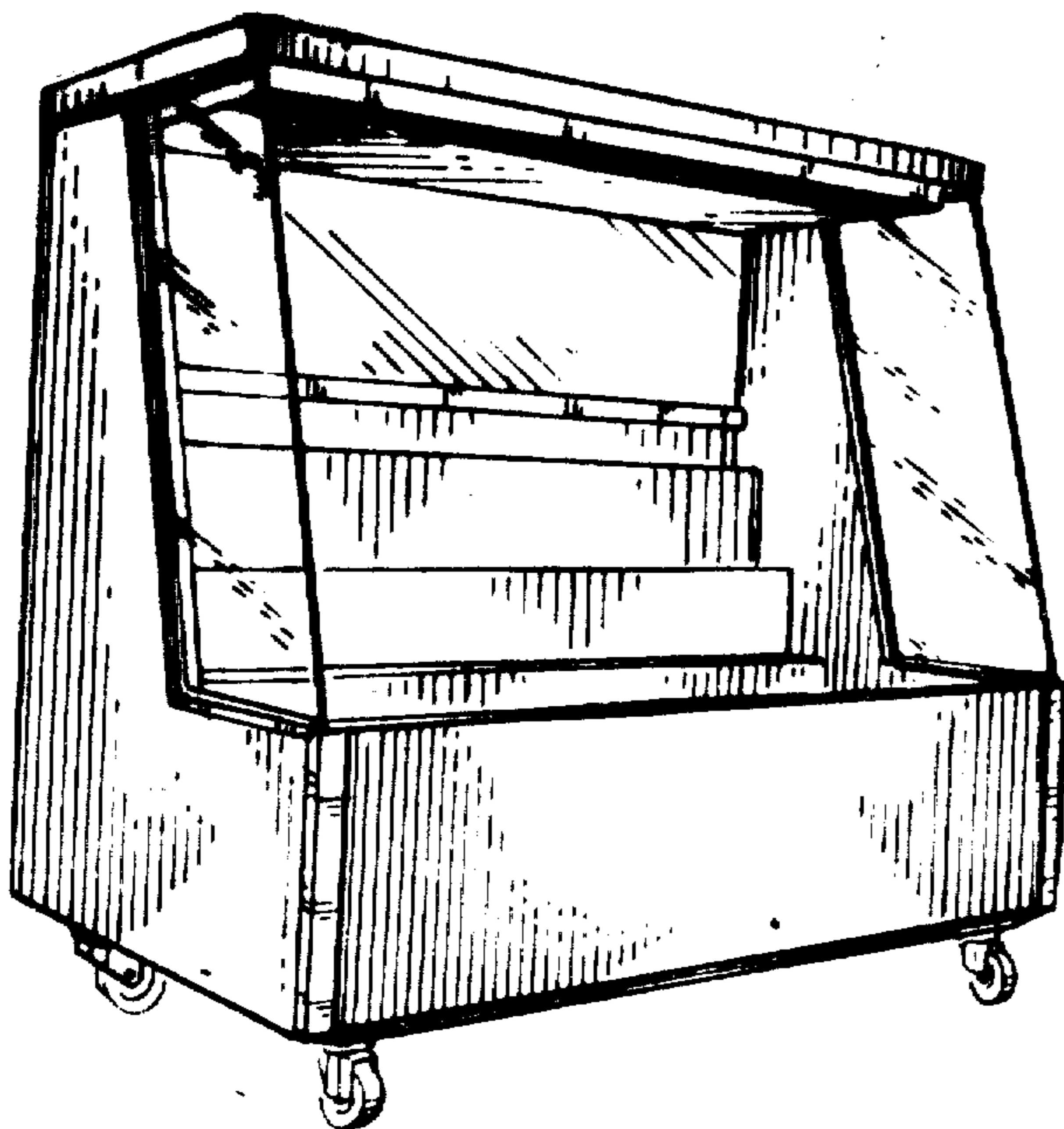

FIG.3

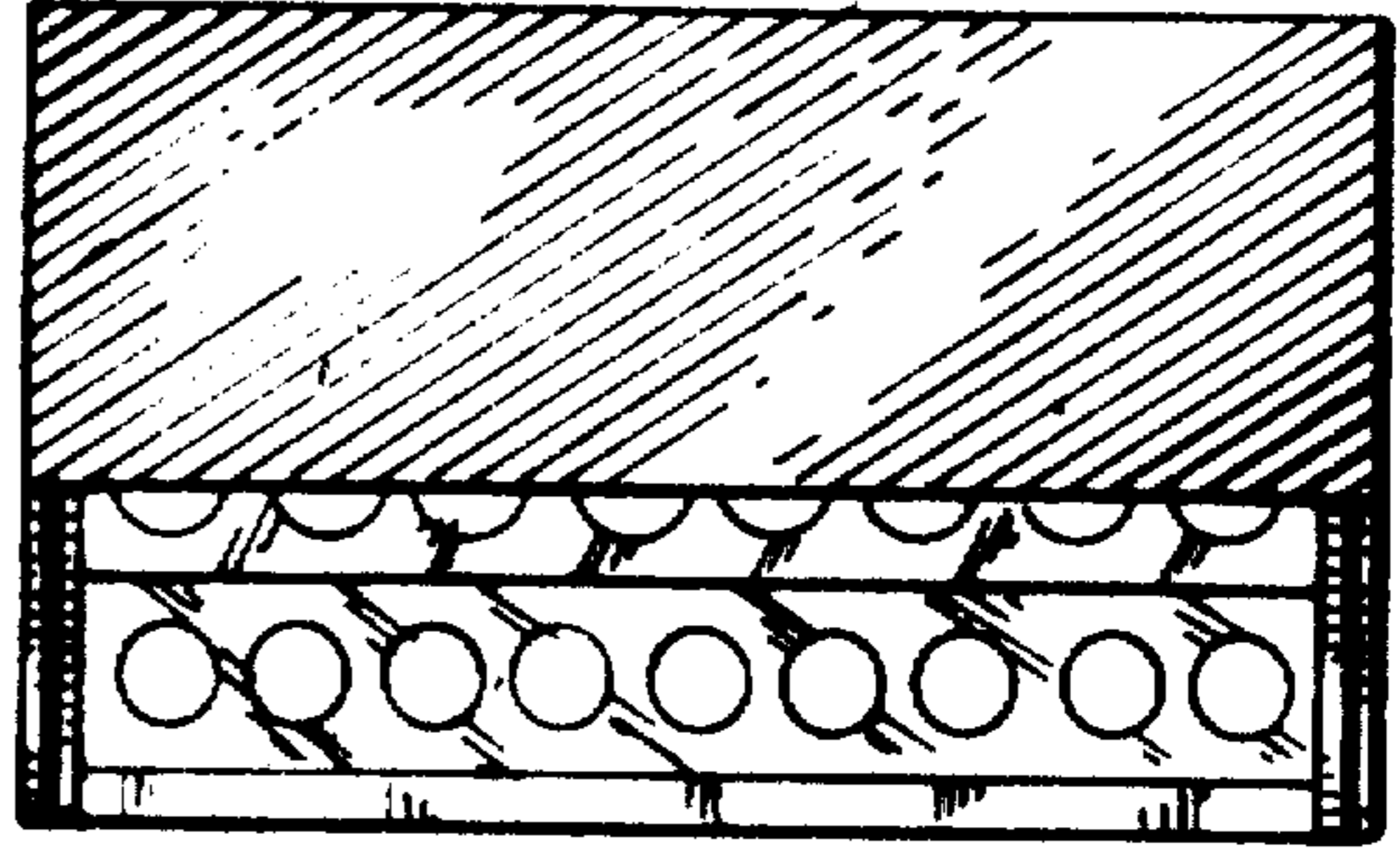

FIG.2

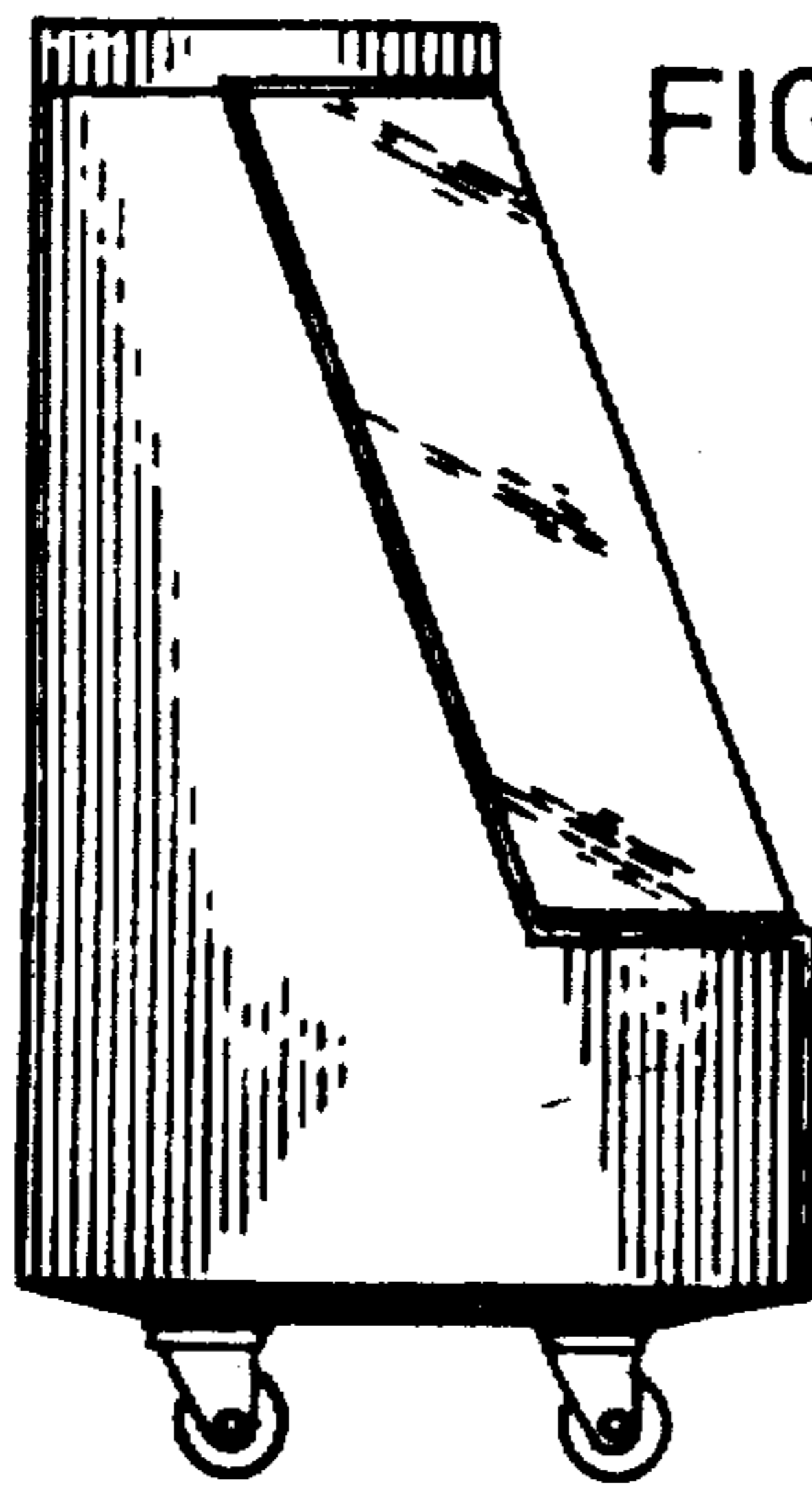

FIG.4

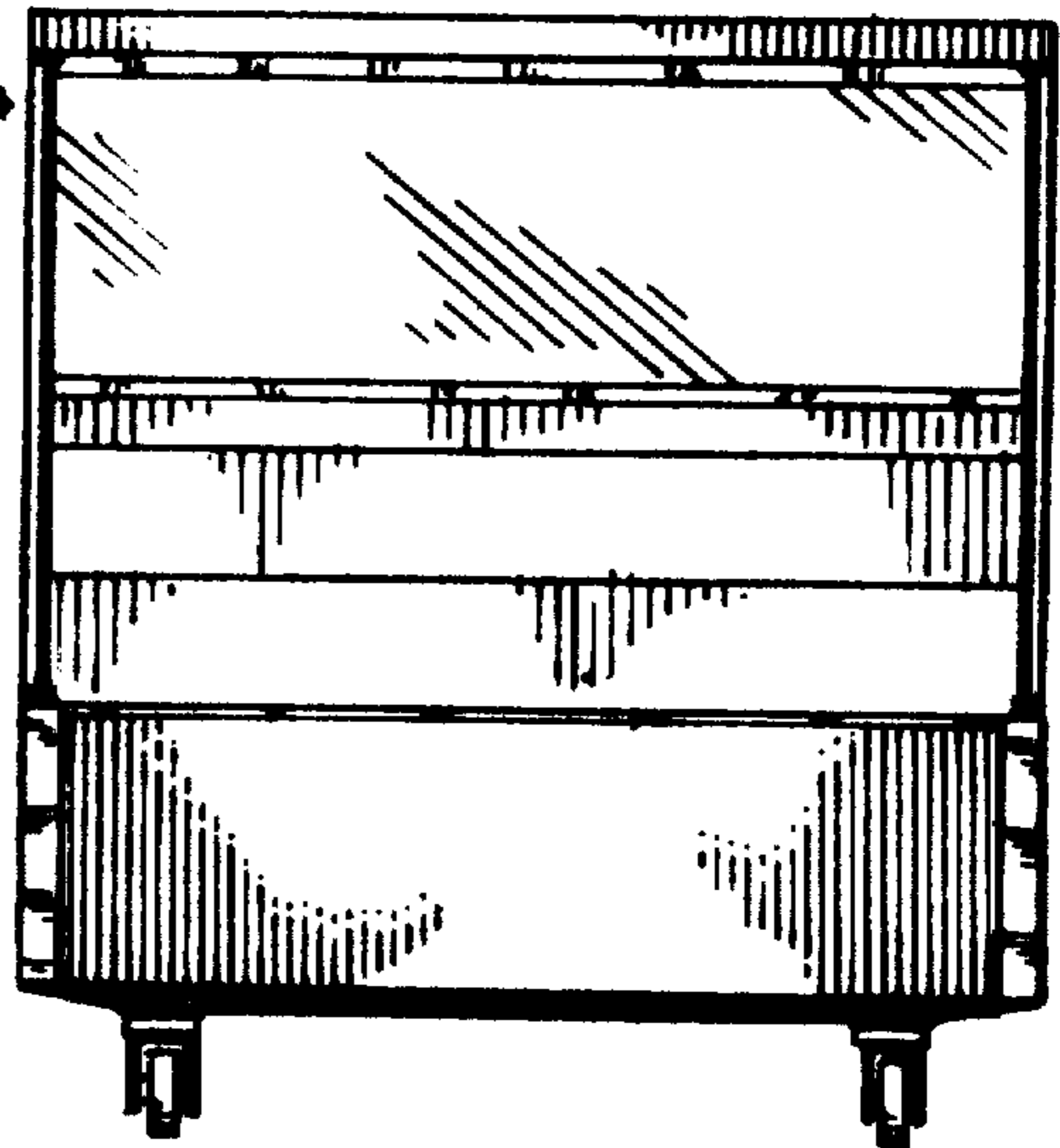

FIG.1

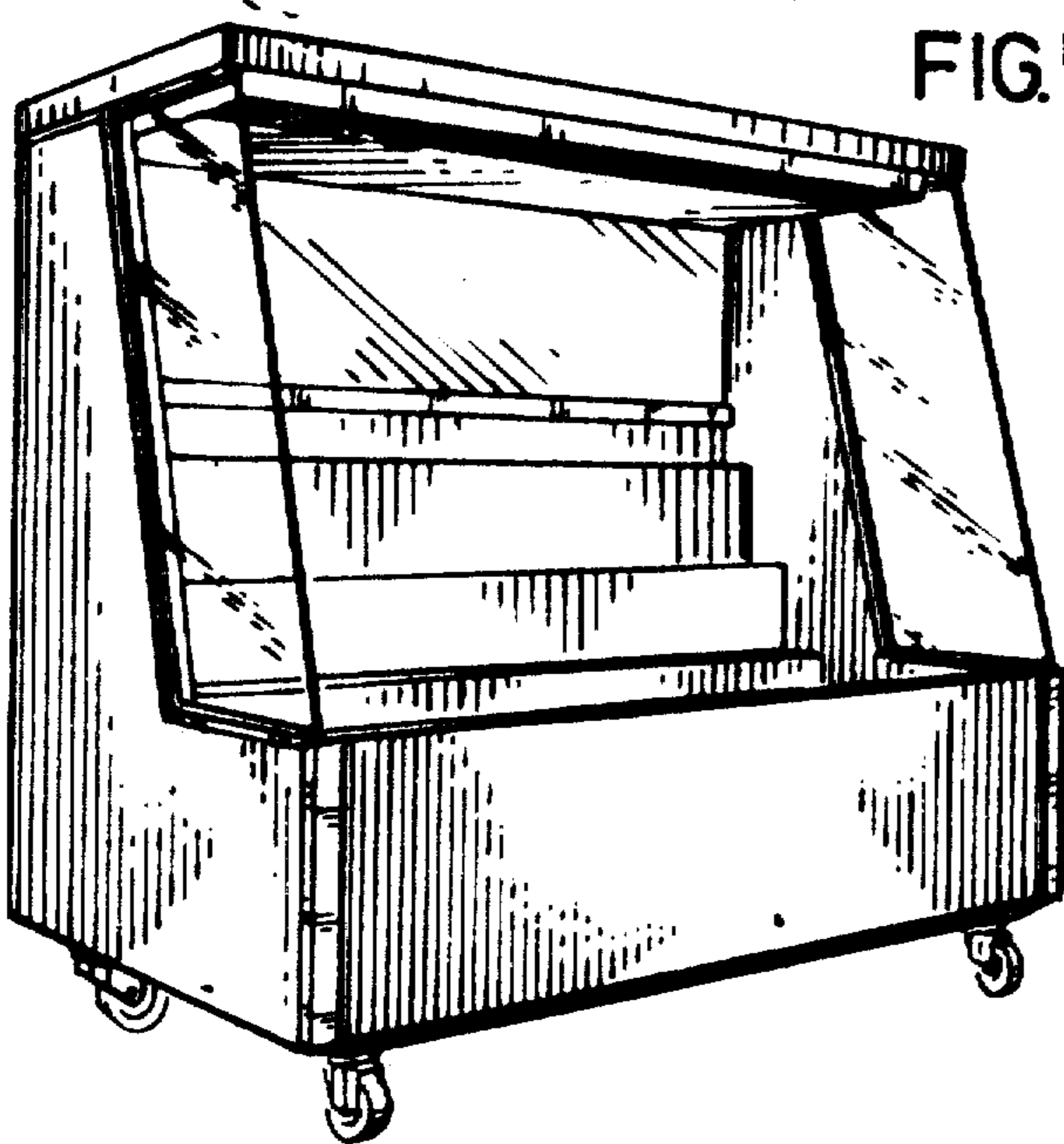

FIG.5

