

[54] STORAGE CASE FOR BABY TEETH

[76] Inventor: Charles J. Zarganis, 916 Evergreen Way, Millbrae, Calif. 94030

[\*\*] Term: 14 Years

[21] Appl. No.: 482,632

[22] Filed: Apr. 6, 1983

[52] U.S. Cl. .... D3/66; D3/46; D21/155; D21/168; D21/178

[58] Field of Search ..... D3/30.1, 44-47, D3/66; D19/59-62; D21/64, 59, 168, 169, 177, 178, 155; D6/528

[56] References Cited

U.S. PATENT DOCUMENTS

D. 78,999	7/1929	Knorer	.....	D3/66
D. 165,469	12/1951	Katz	.....	D21/169
D. 184,739	3/1959	Kanter	.....	D6/528
D. 262,979	2/1982	Saitoh	.....	D21/64
D. 262,982	2/1982	Abe et al.	.....	D21/177
D. 276,537	11/1984	Tabachnik	.....	D21/178

OTHER PUBLICATIONS

Tooth Fairy Helper, Zarland Books ©1980.

Primary Examiner—George P. Word  
Attorney, Agent, or Firm—Fliesler, Dubb, Meyer & Lovejoy

[57] CLAIM

The ornamental design of a storage case for baby teeth, as shown and described.

DESCRIPTION

FIG. 1 is a perspective view of a storage case for baby teeth showing my new design;  
FIG. 2 is a perspective view thereof in the open position and showing the interior of the storage case;  
FIG. 3 is a front elevational view of FIG. 1;  
FIG. 4 is a left side elevational view thereof;  
FIG. 5 is a right side elevational view thereof;  
FIG. 6 is a top plan view thereof;  
FIG. 7 is a bottom plan view thereof; and  
FIG. 8 is a rear elevational view thereof.

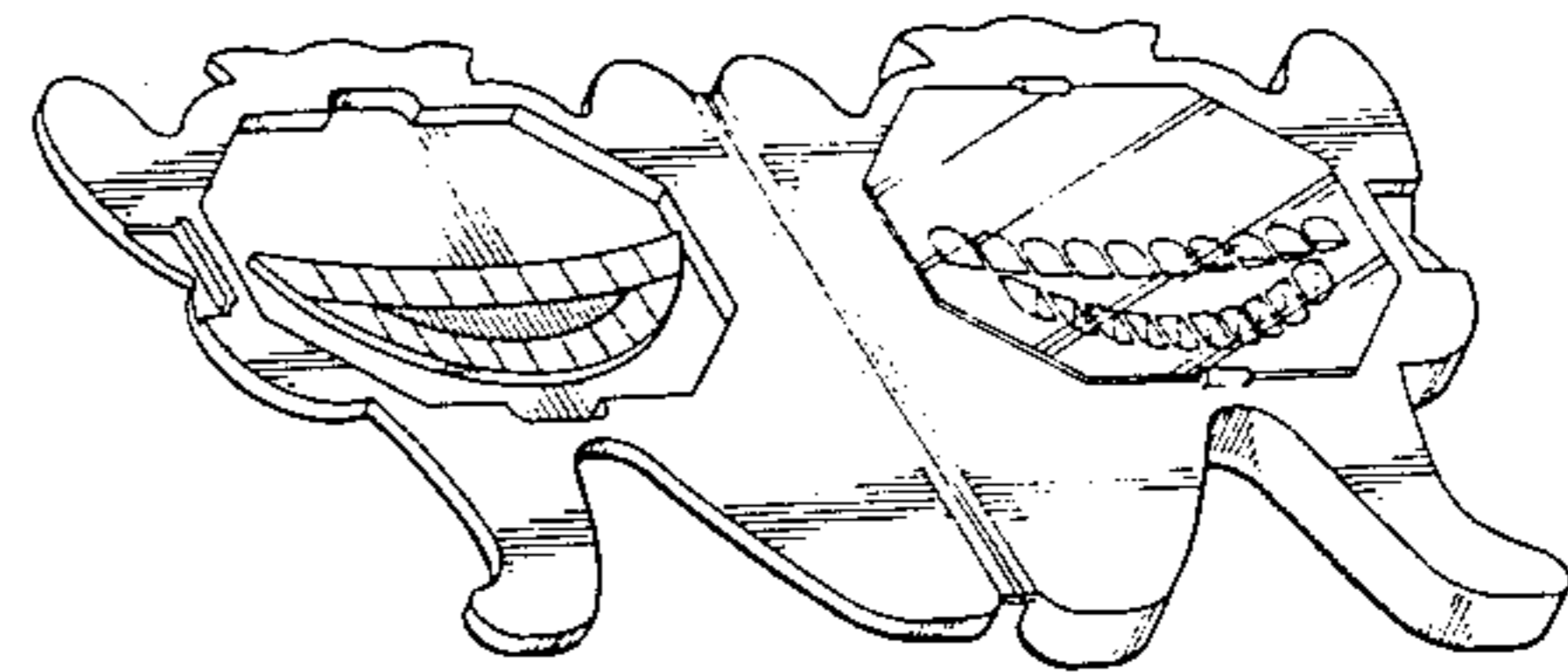
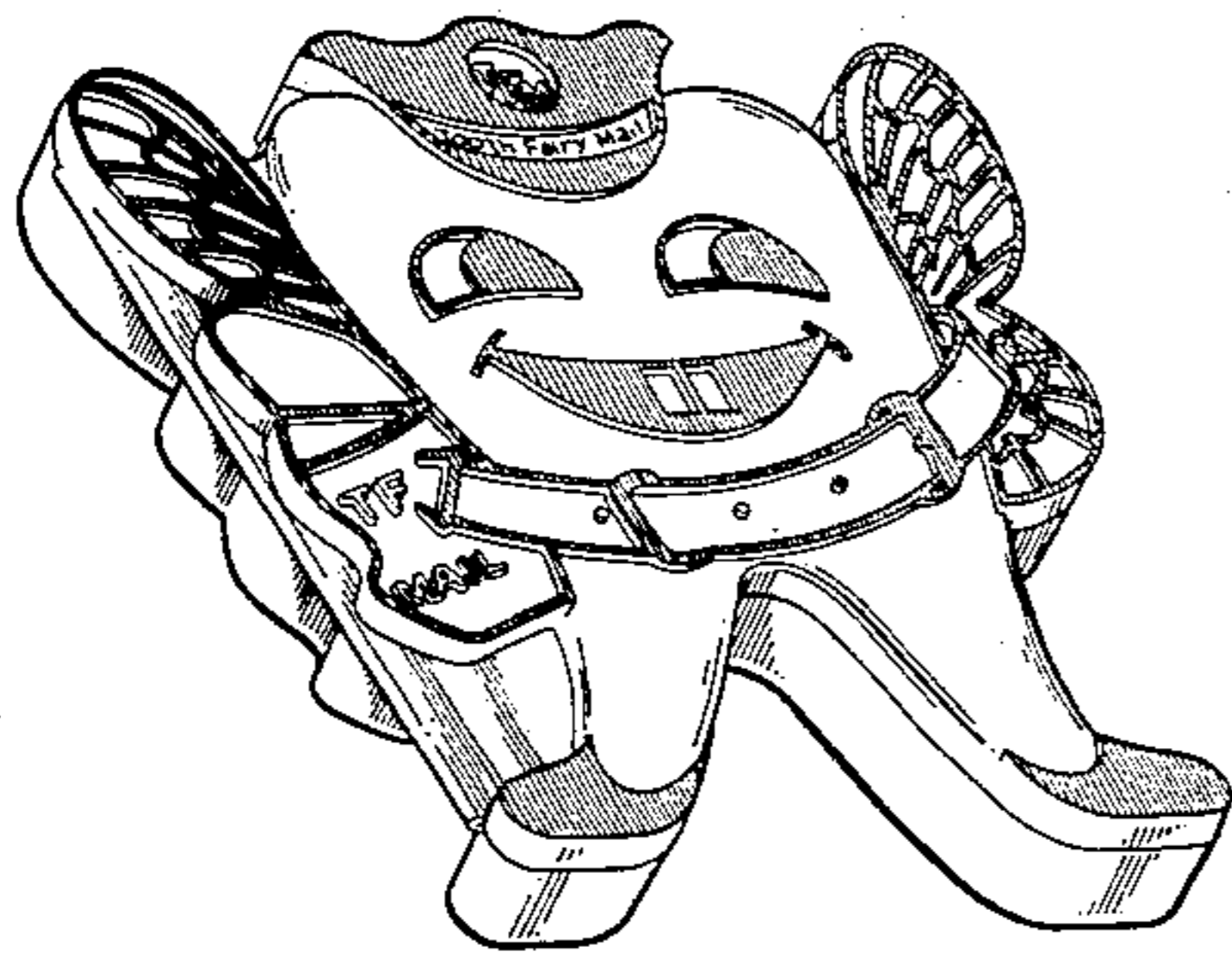

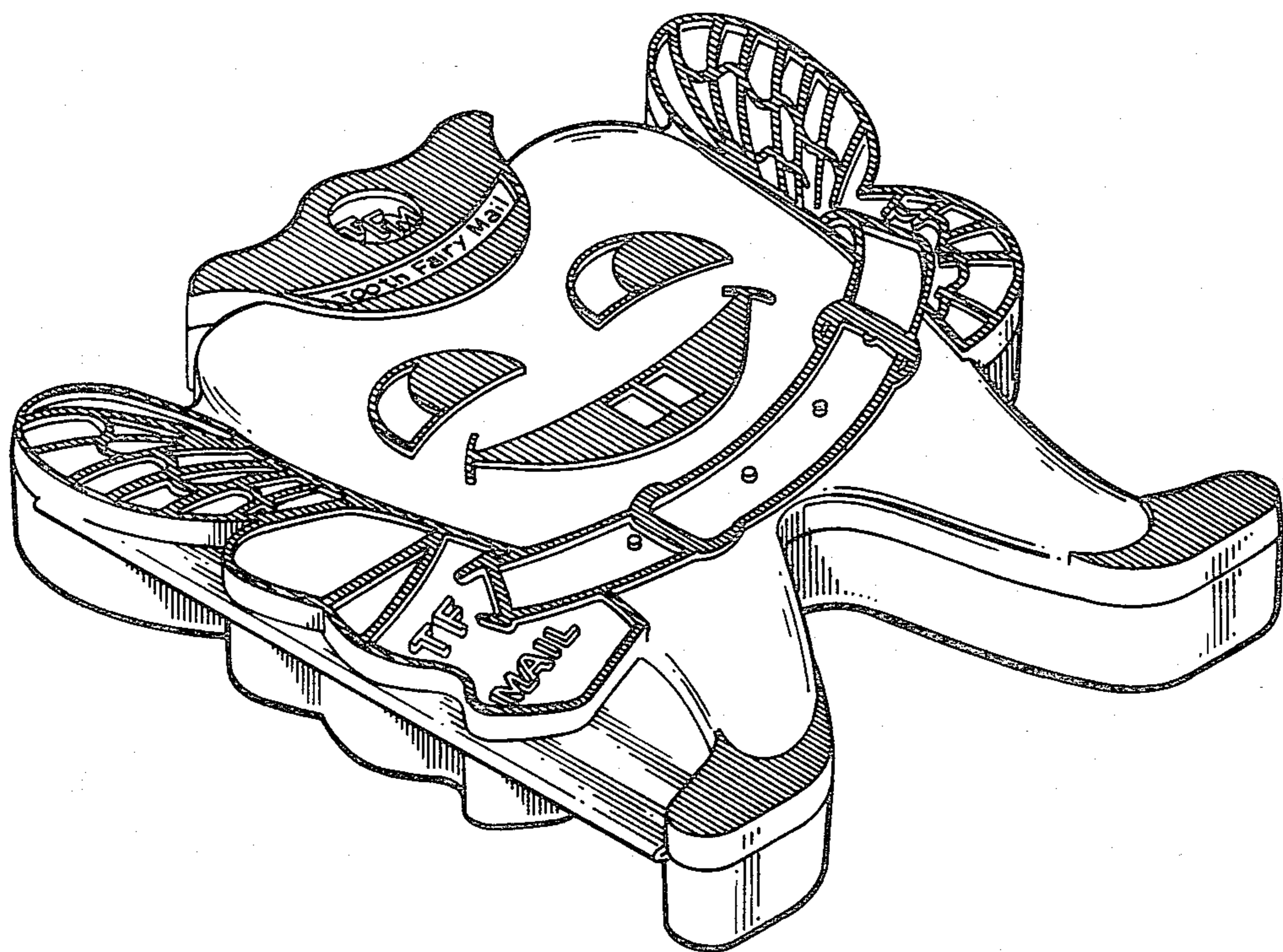

FIGURE 1

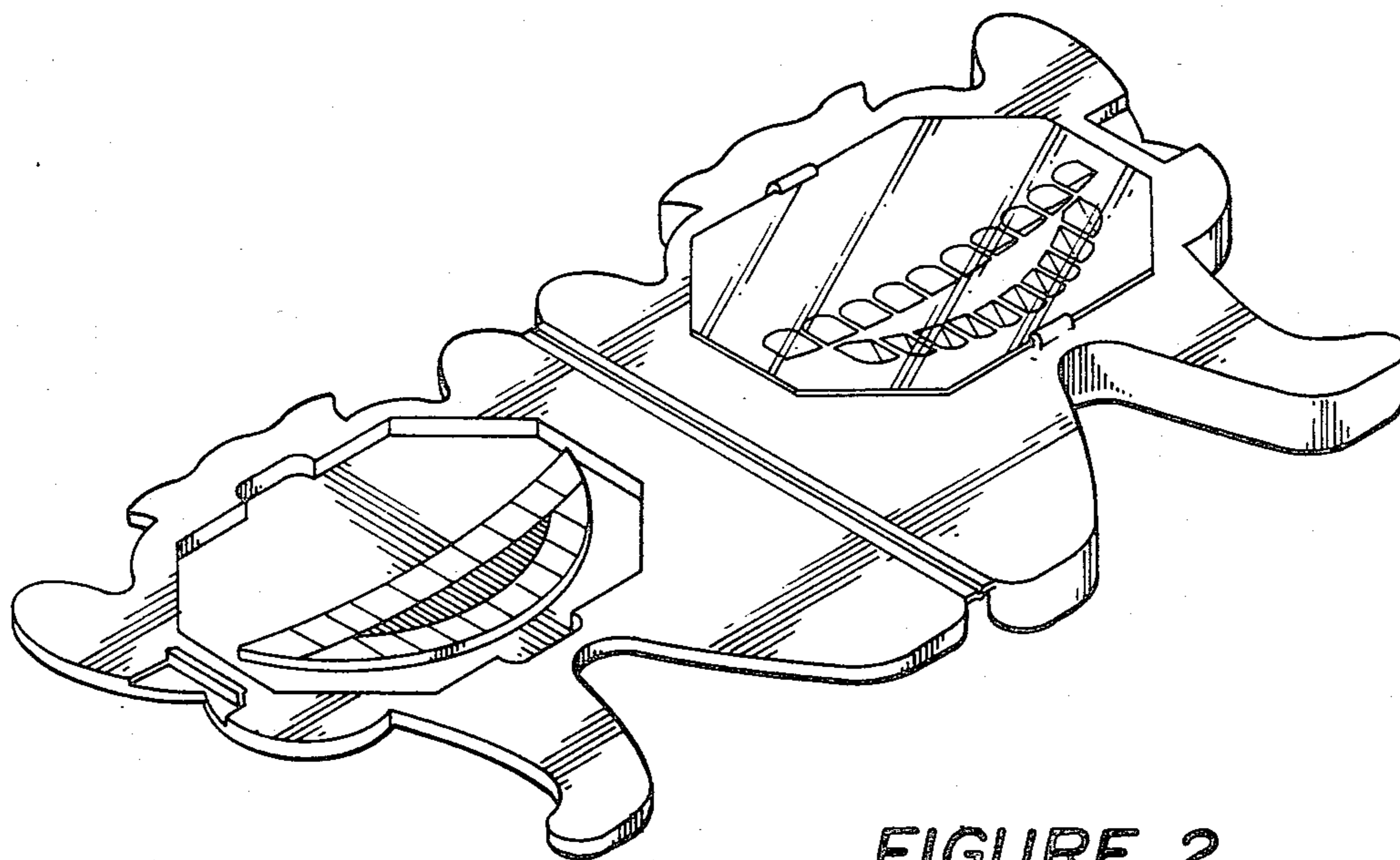

FIGURE 2

FIGURE 6

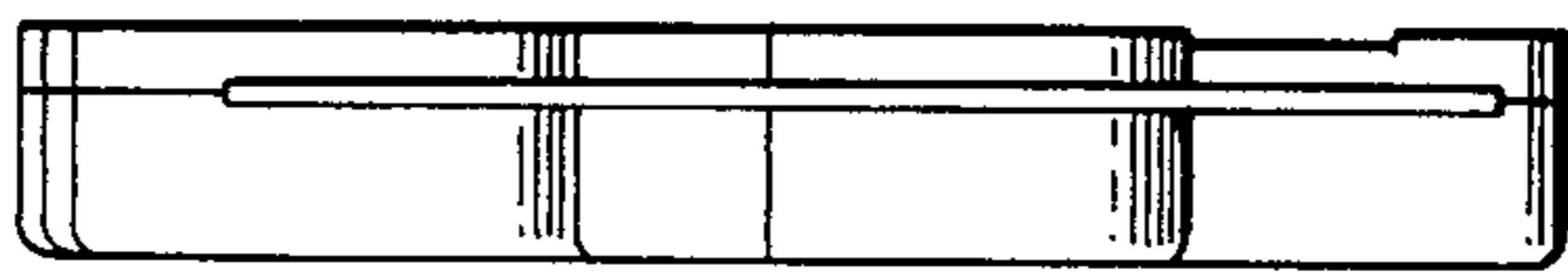
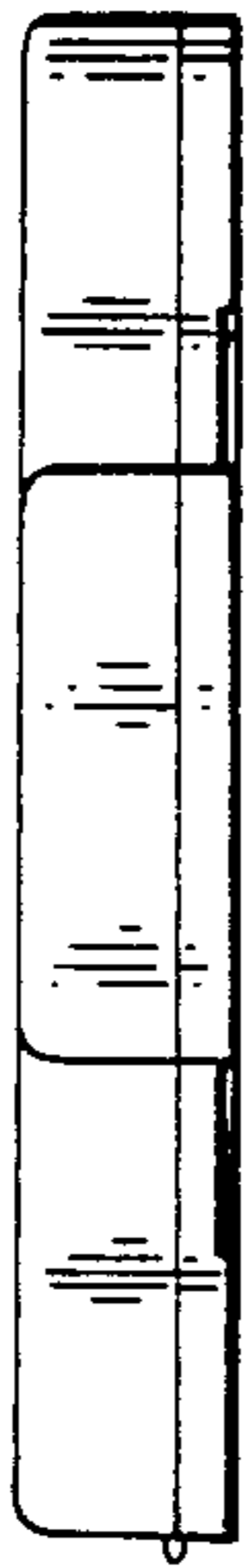

FIGURE 4

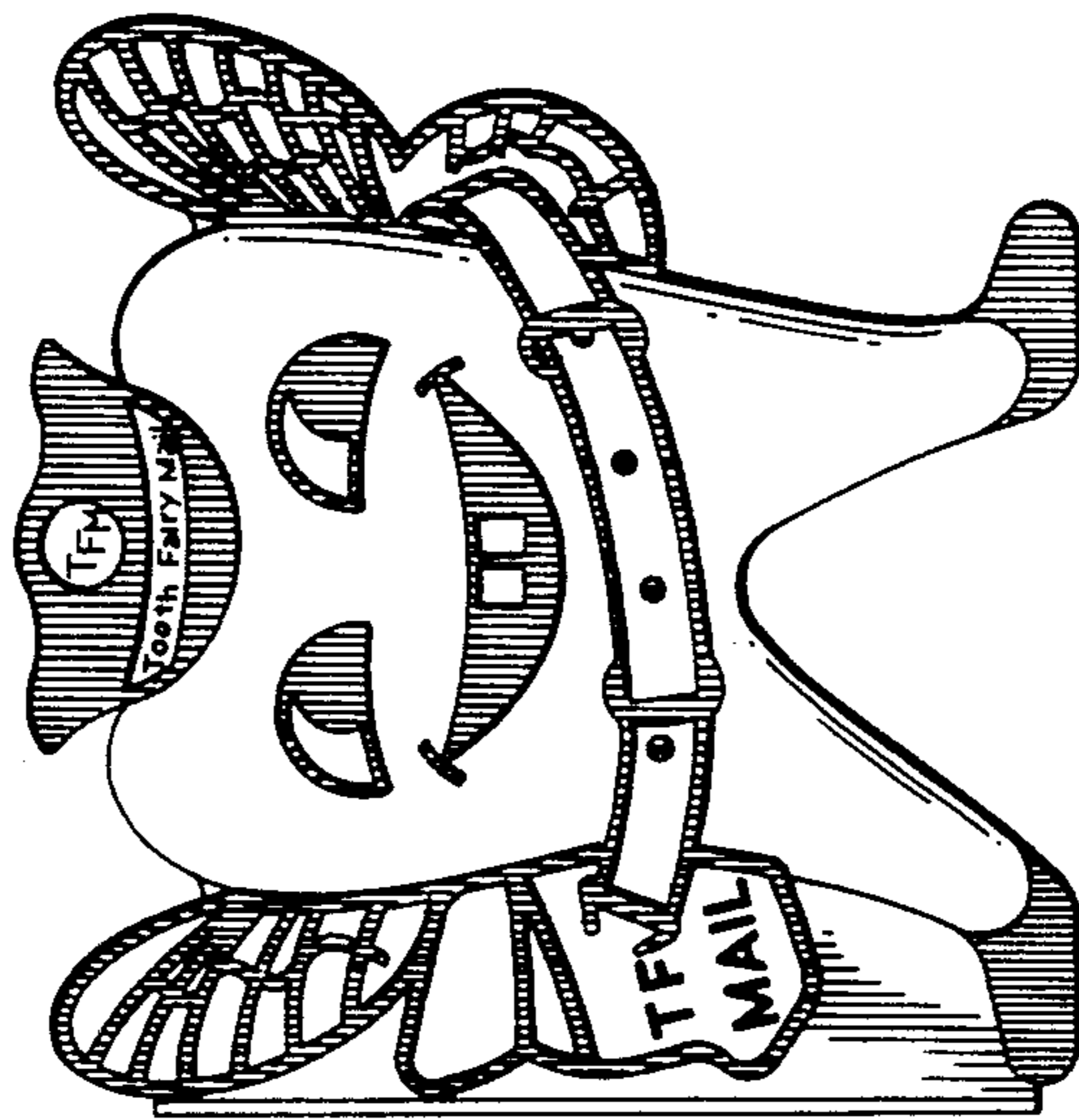

FIGURE 3

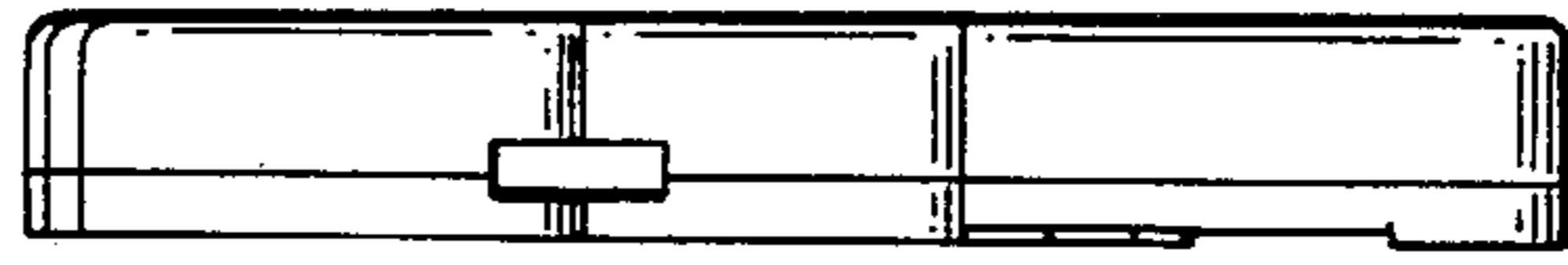

FIGURE 5

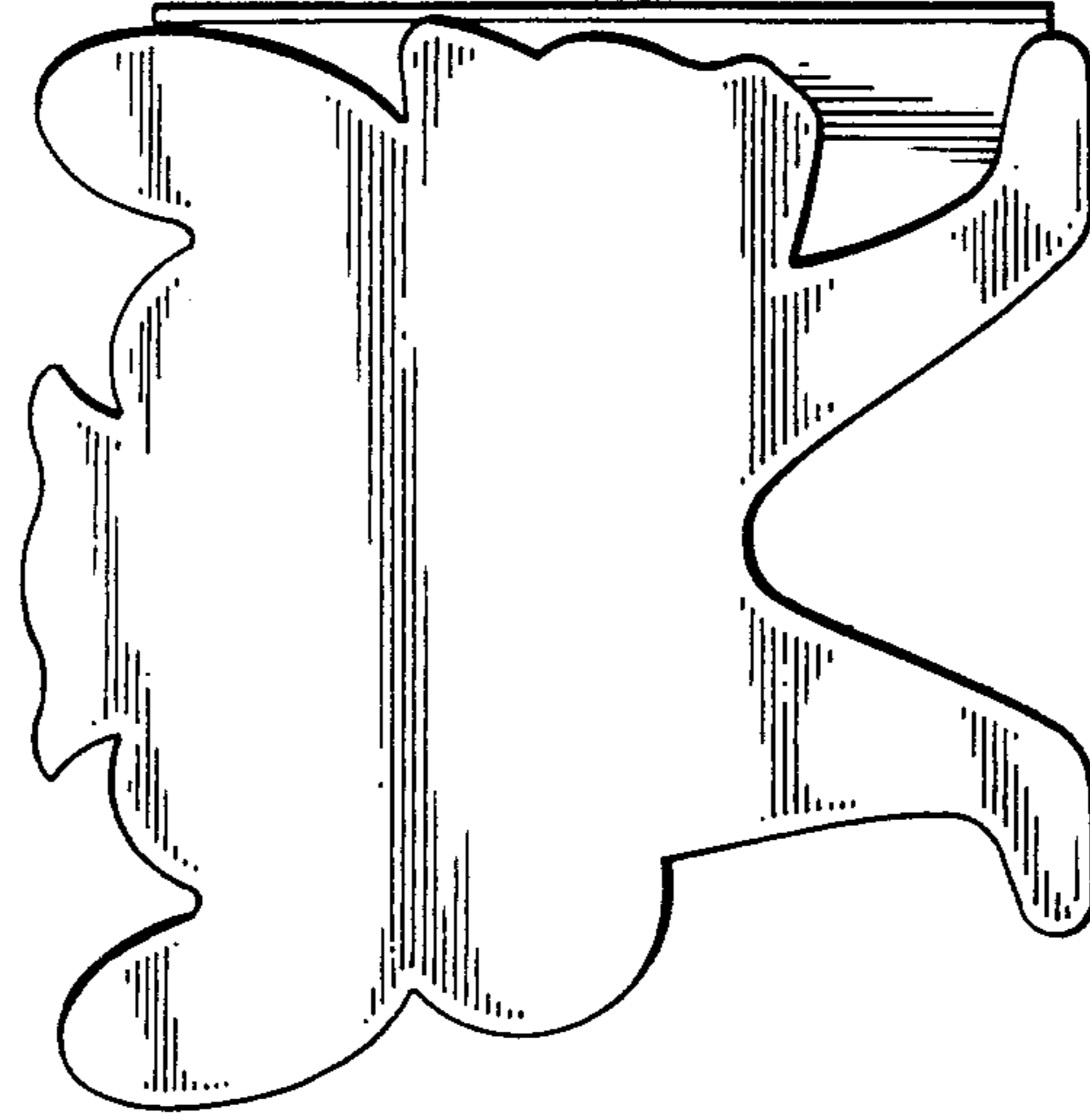

FIGURE 8



FIGURE 7