

[54] **DESK RECEPTACLE FOR WRITING INSTRUMENTS AND OFFICE SUPPLIES OR THE LIKE**

[76] Inventor: **Henry C. Wang**, No. 197-2, Chung-Shiau E. Rd., Sec. 3, Taipei, Taiwan

[**] Term: **14 Years**

[21] Appl. No.: **418,054**

[22] Filed: **Sep. 14, 1982**

[52] U.S. Cl. **D19/77; D19/85**

[58] Field of Search **D6/145, 157, 181; D3/74, 75, 78; D19/75, 77, 85; D9/420, 422; D7/81; 211/69.1, 78; 206/314**

[56] **References Cited**

U.S. PATENT DOCUMENTS

- D. 147,482 9/1947 Winterfeld D3/74 X
- D. 185,992 8/1959 D'Arbeloff D3/75
- D. 199,820 12/1964 Meeker D3/75
- D. 267,153 12/1982 Lebowitz D3/74 X
- 1,831,401 11/1931 Weidlich et al. D3/75 X

- 3,392,868 7/1968 Pfrommer D9/422 X
- 3,760,521 9/1973 Barraya D6/145 X

Primary Examiner—Carmen H. Vales
Attorney, Agent, or Firm—Leonard Bloom

[57] **CLAIM**

The ornamental design for desk receptacle for writing instruments and office supplies or the like, as shown and described.

DESCRIPTION

FIG. 1 is a top plan view of a desk receptacle for writing instruments and office supplies or the like showing my new design;
 FIG. 2 is a front elevational view thereof;
 FIG. 3 is a left side elevational view thereof;
 FIG. 4 is a right side elevational view thereof;
 FIG. 5 is a cross-sectional view taken along line 5—5 of FIG. 1;
 FIG. 6 is a cross-sectional view taken along line 6—6 of FIG. 2;
 FIG. 7 is a perspective view thereof; and
 FIG. 8 is a top plan view with the compartments in open position.

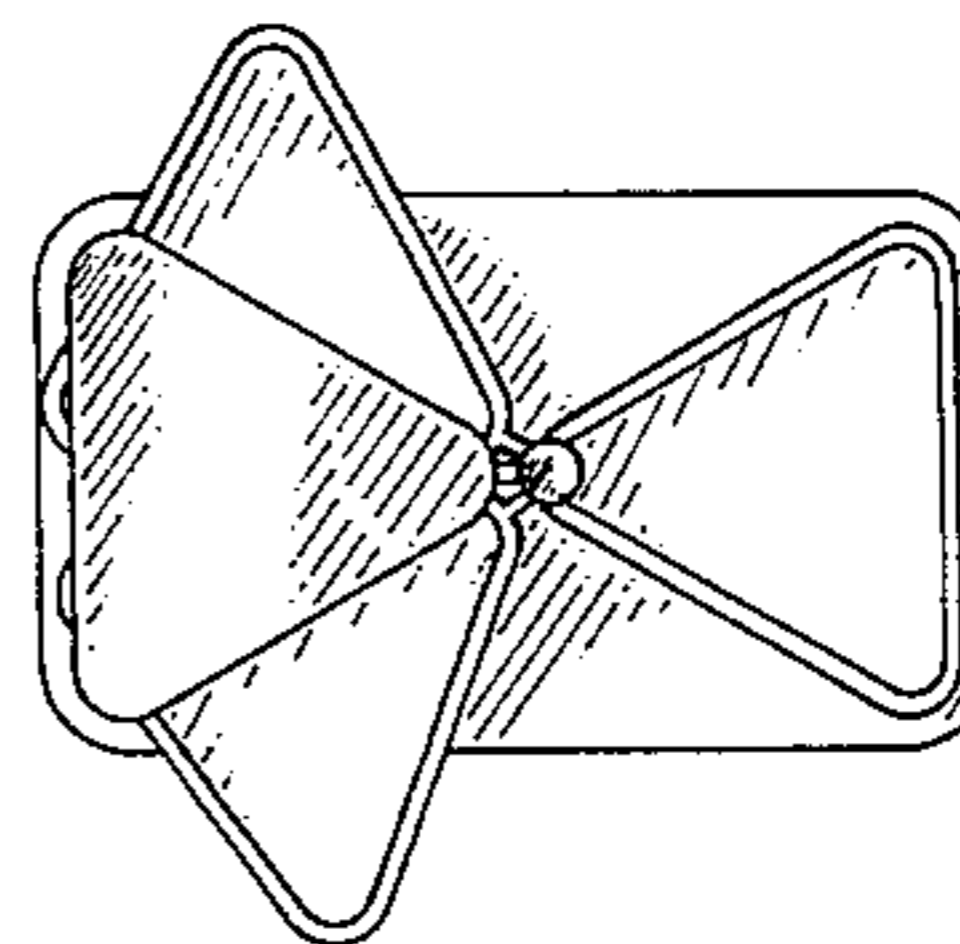
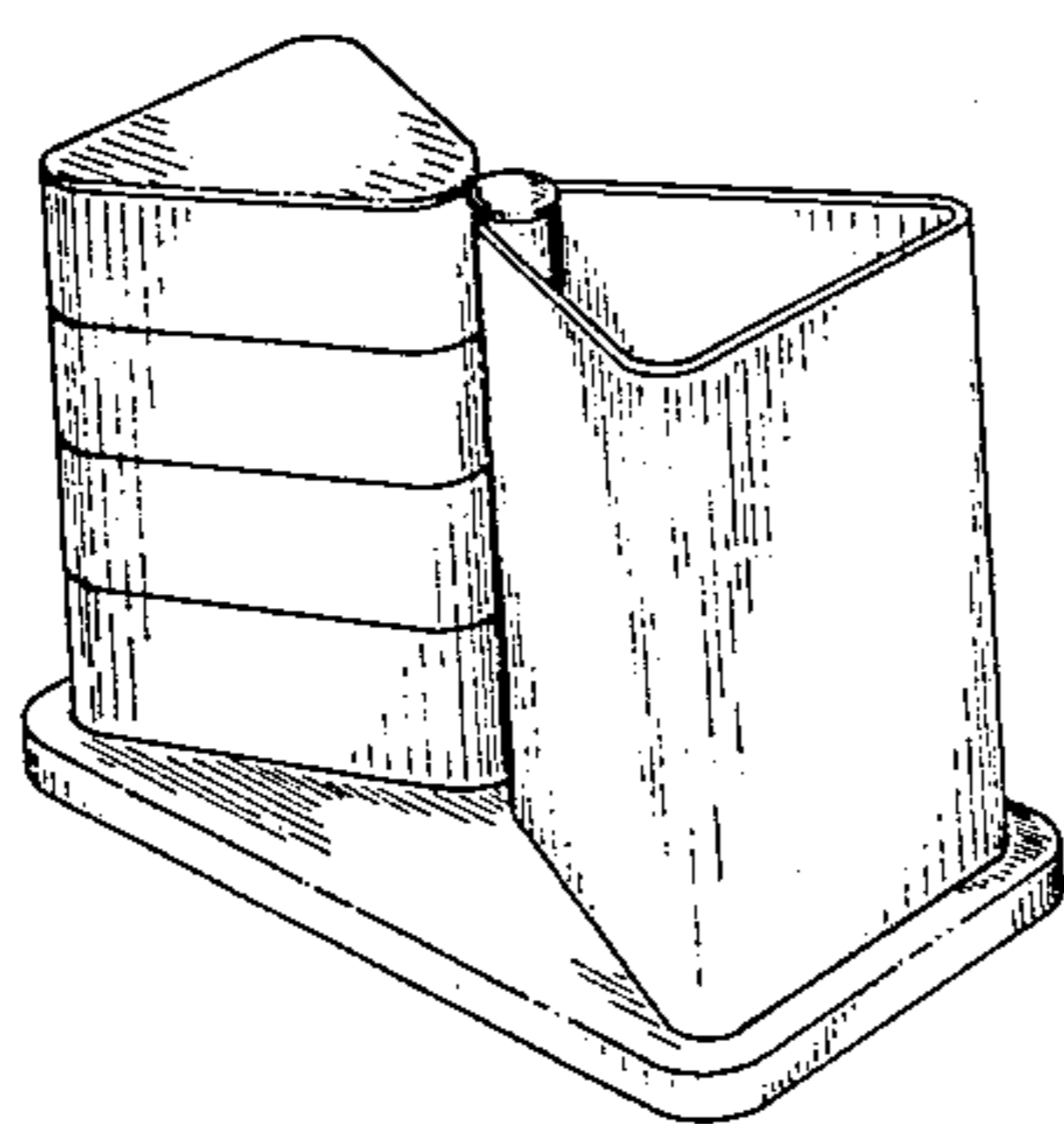

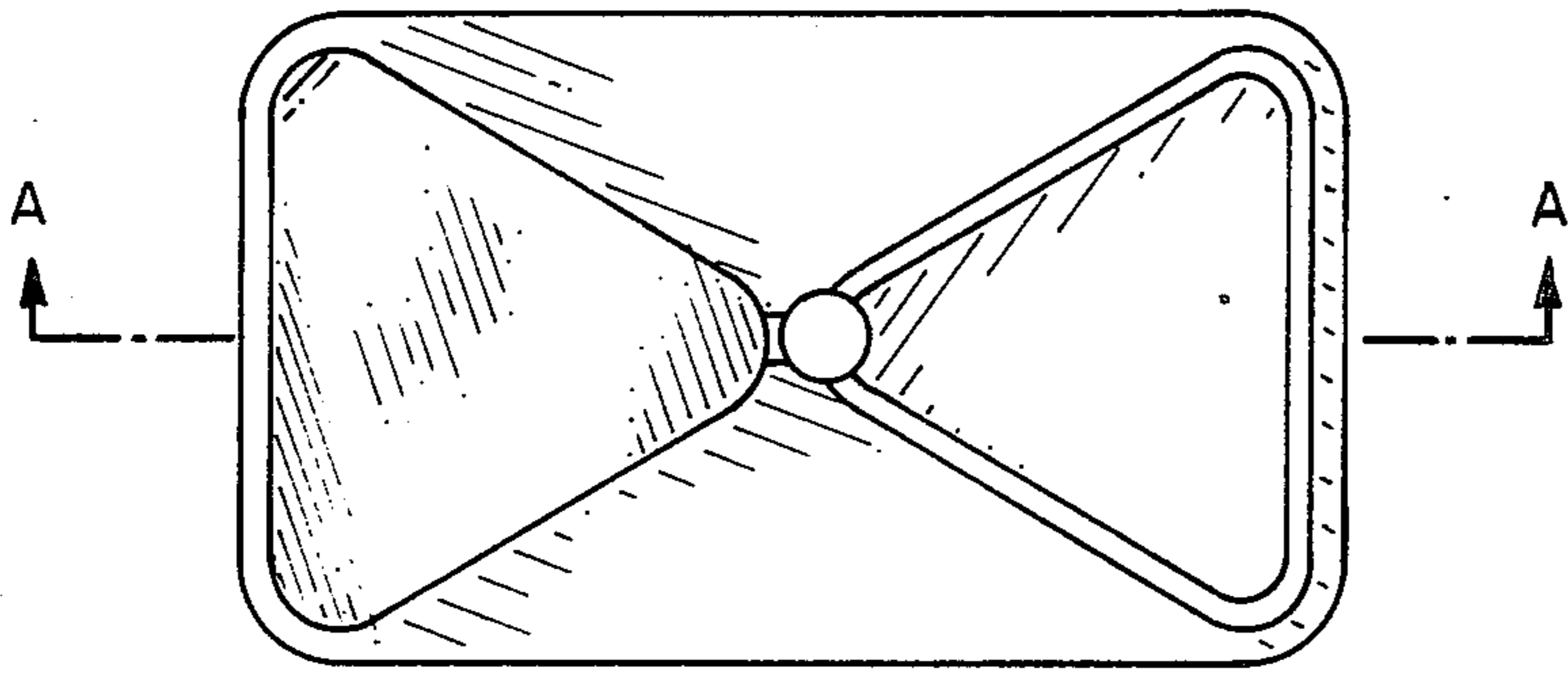

Fig. 1

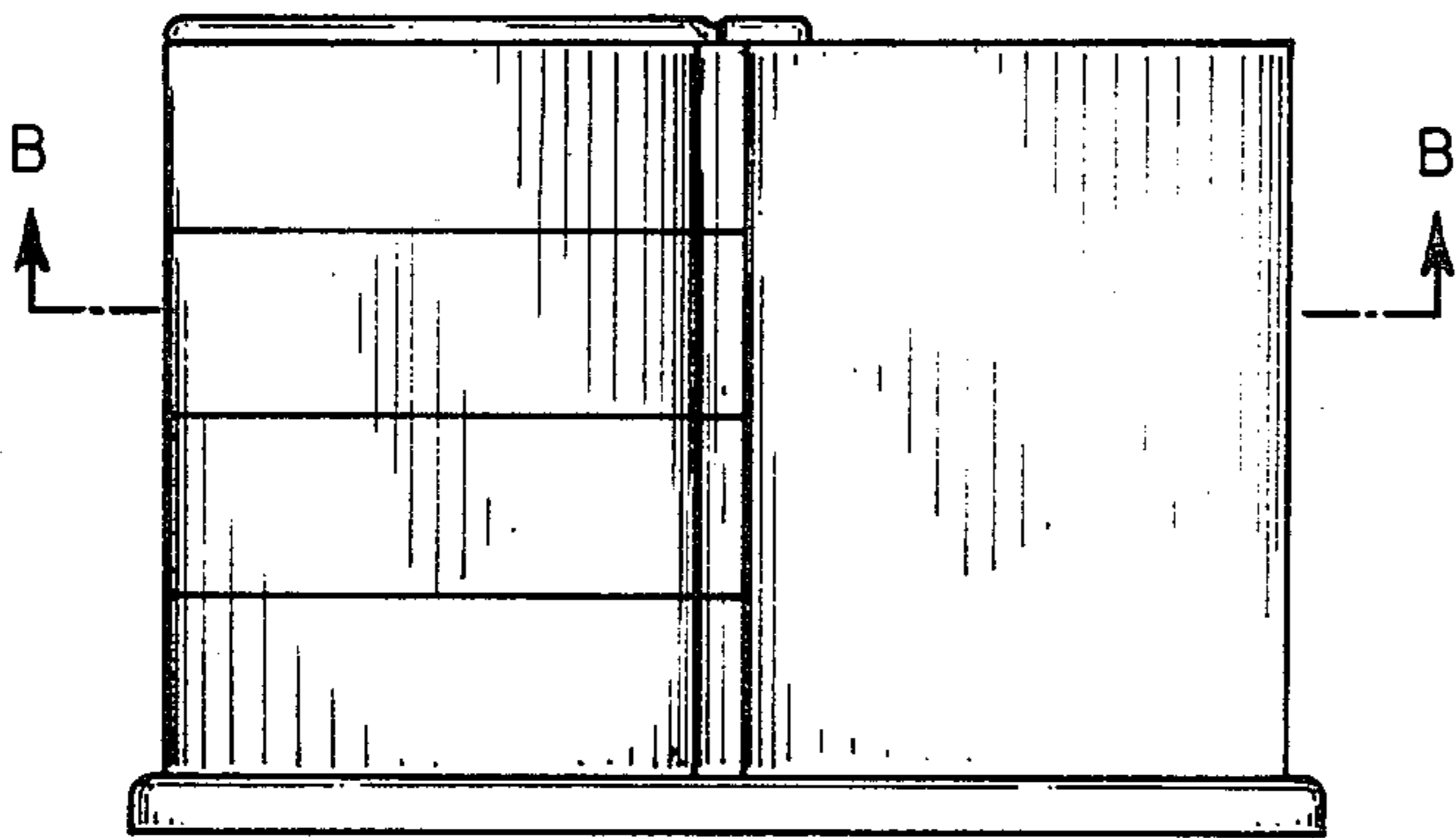

Fig. 2

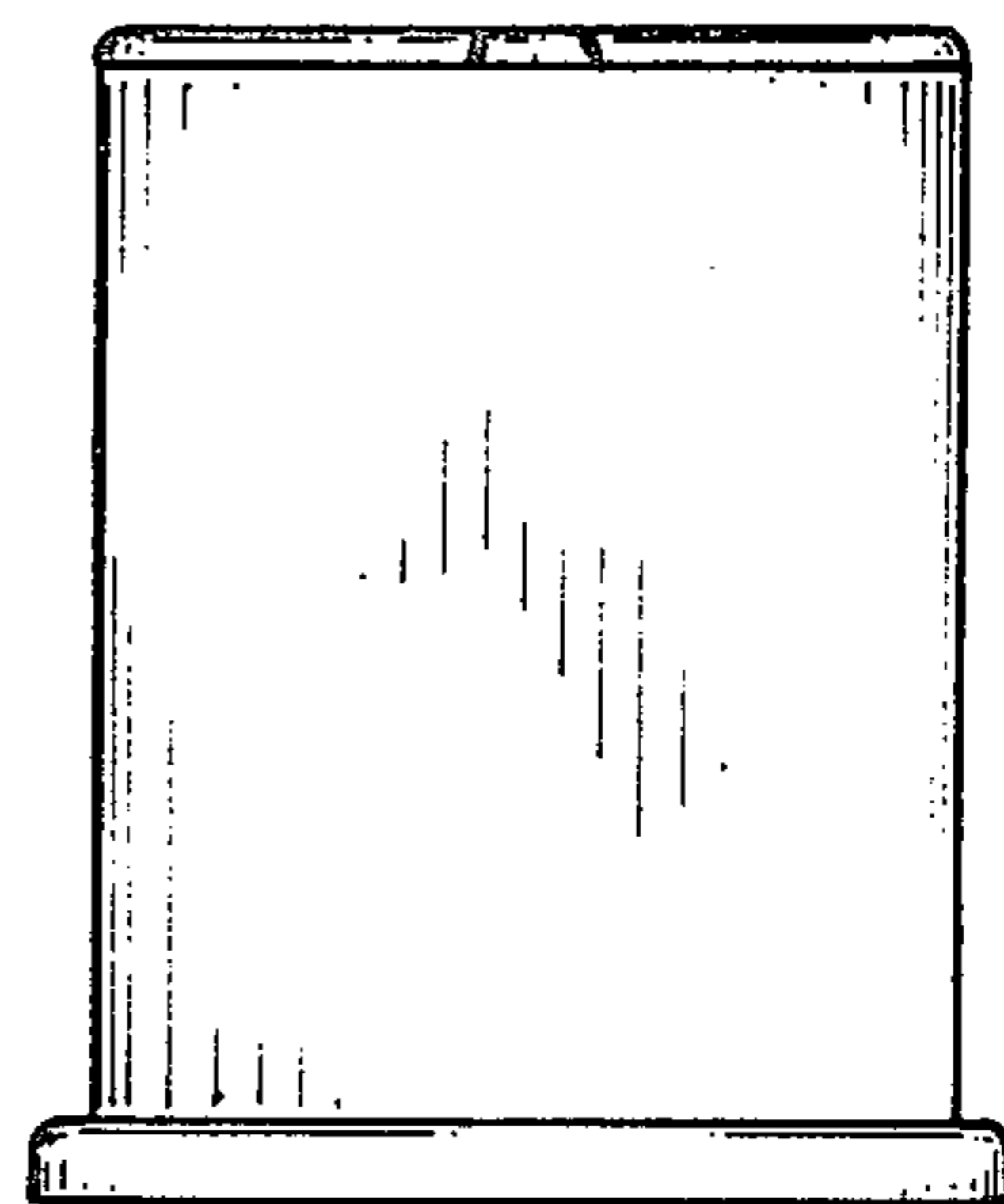

Fig. 4

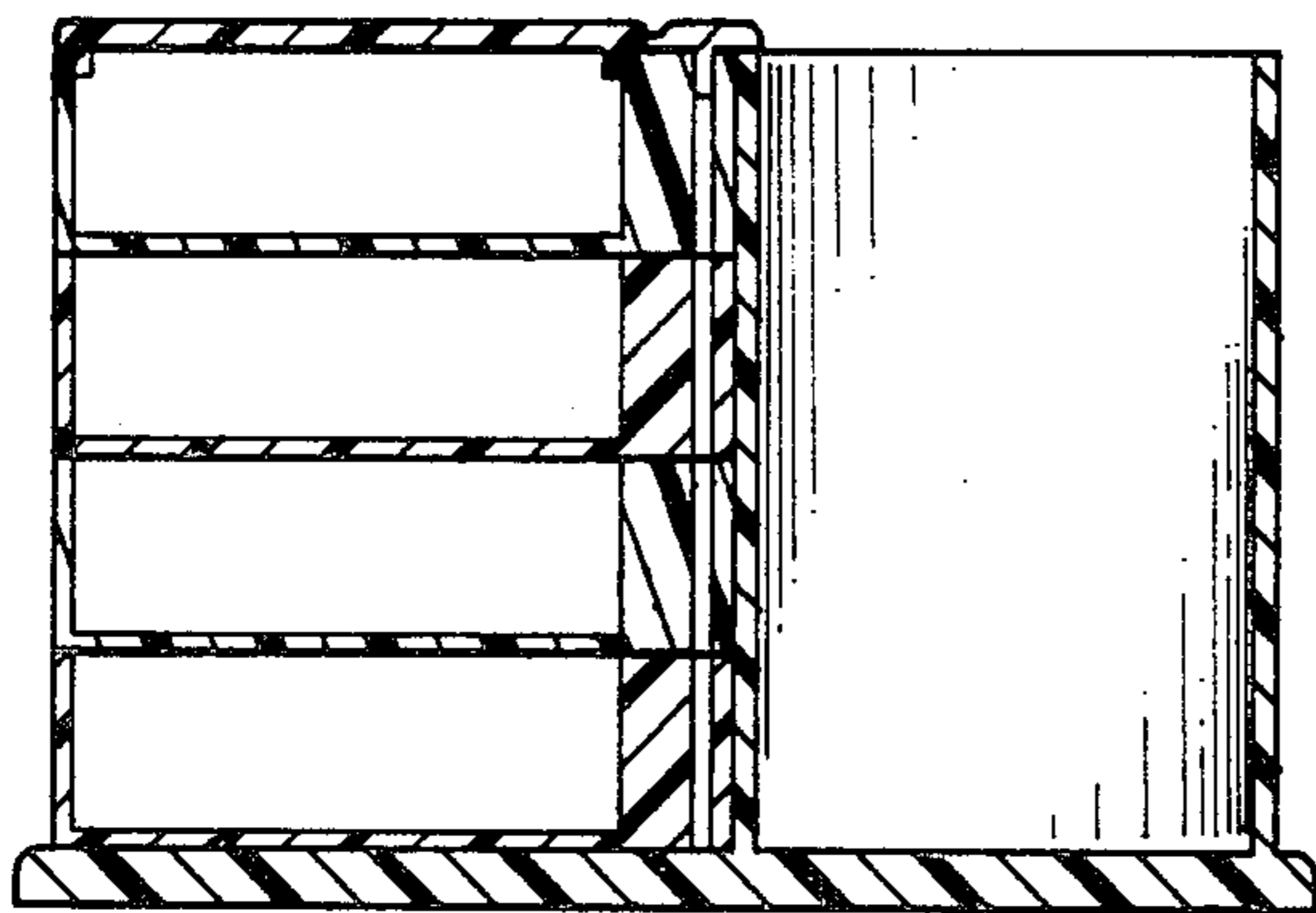

Fig. 5

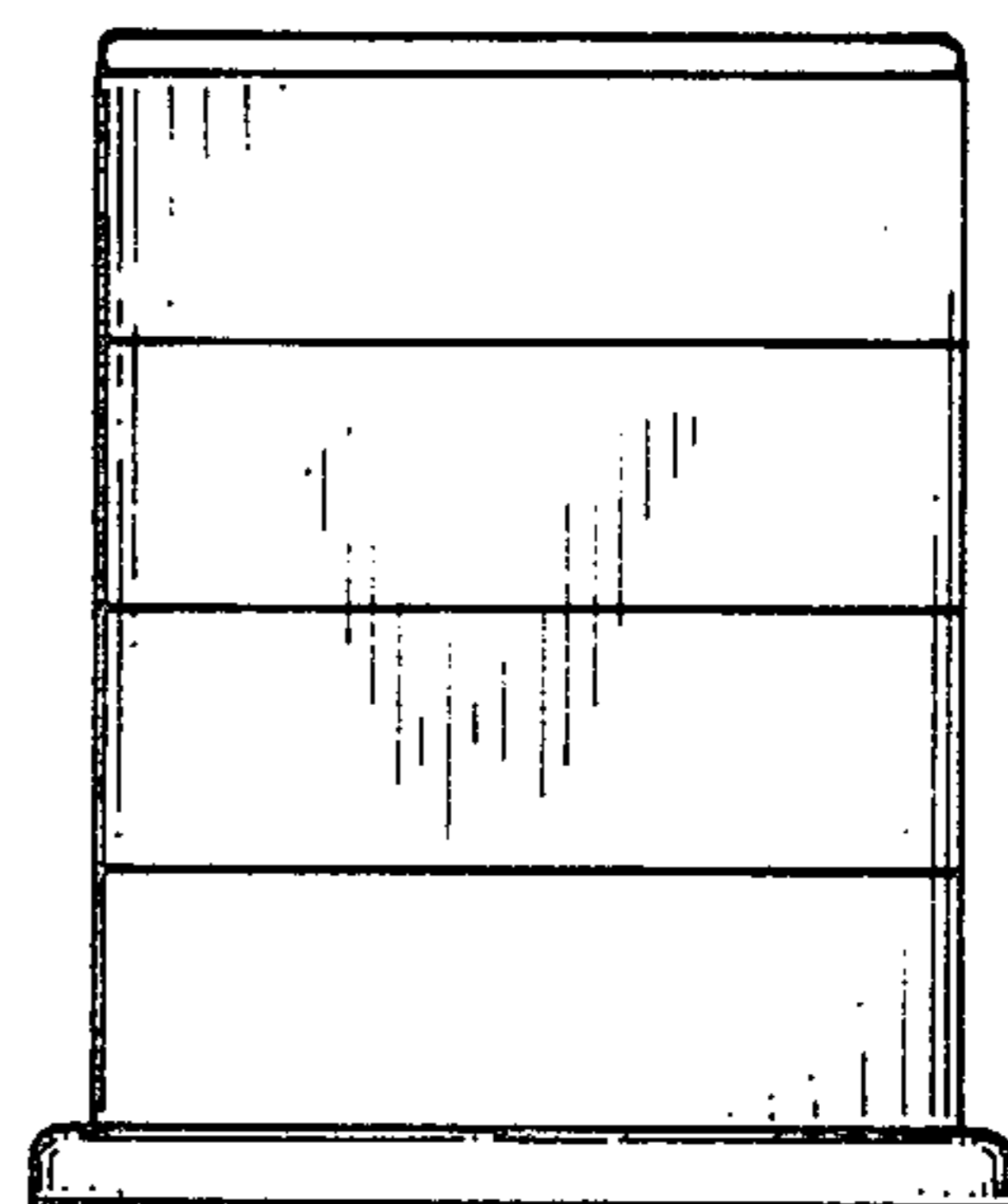

Fig. 3

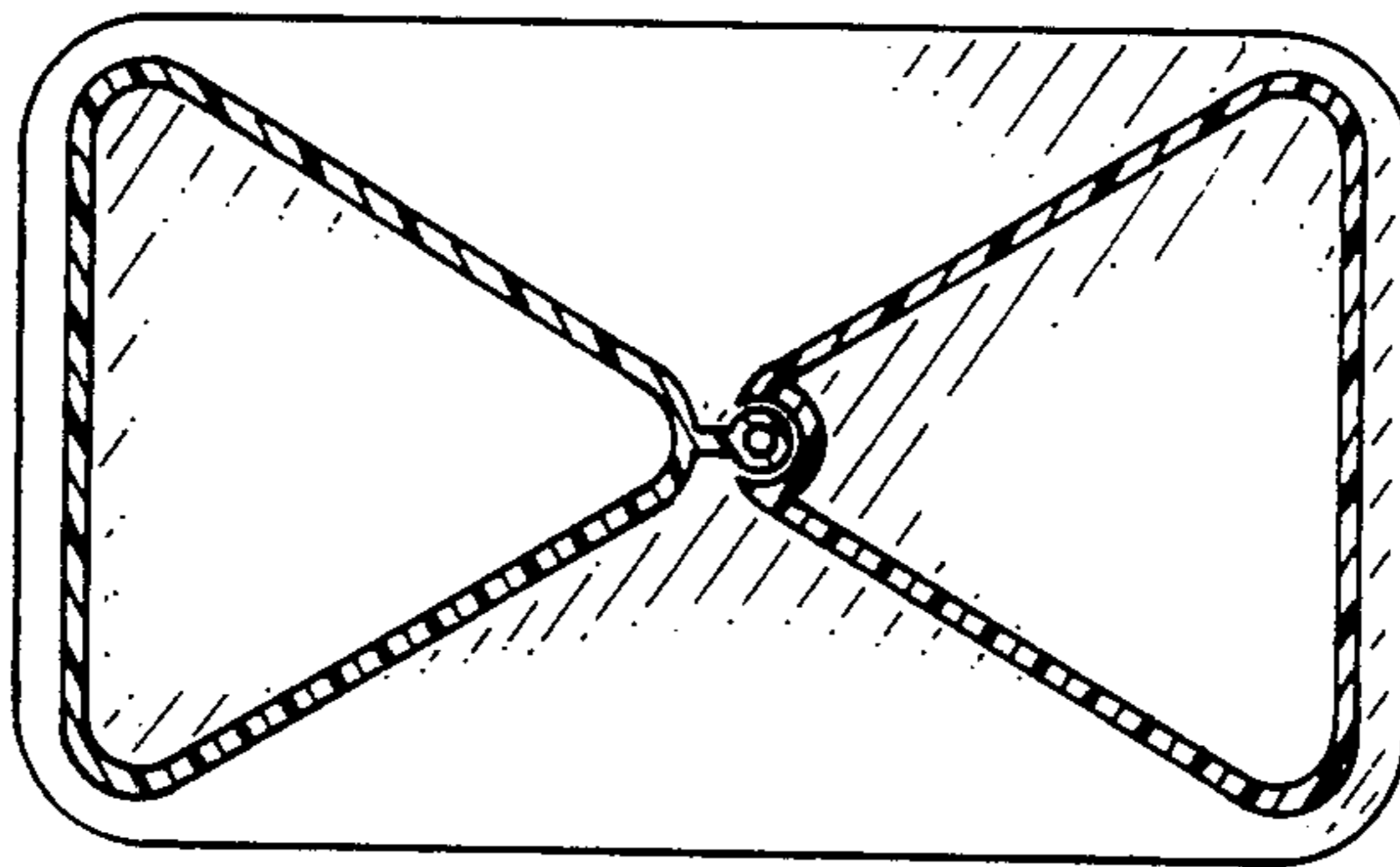

Fig. 6

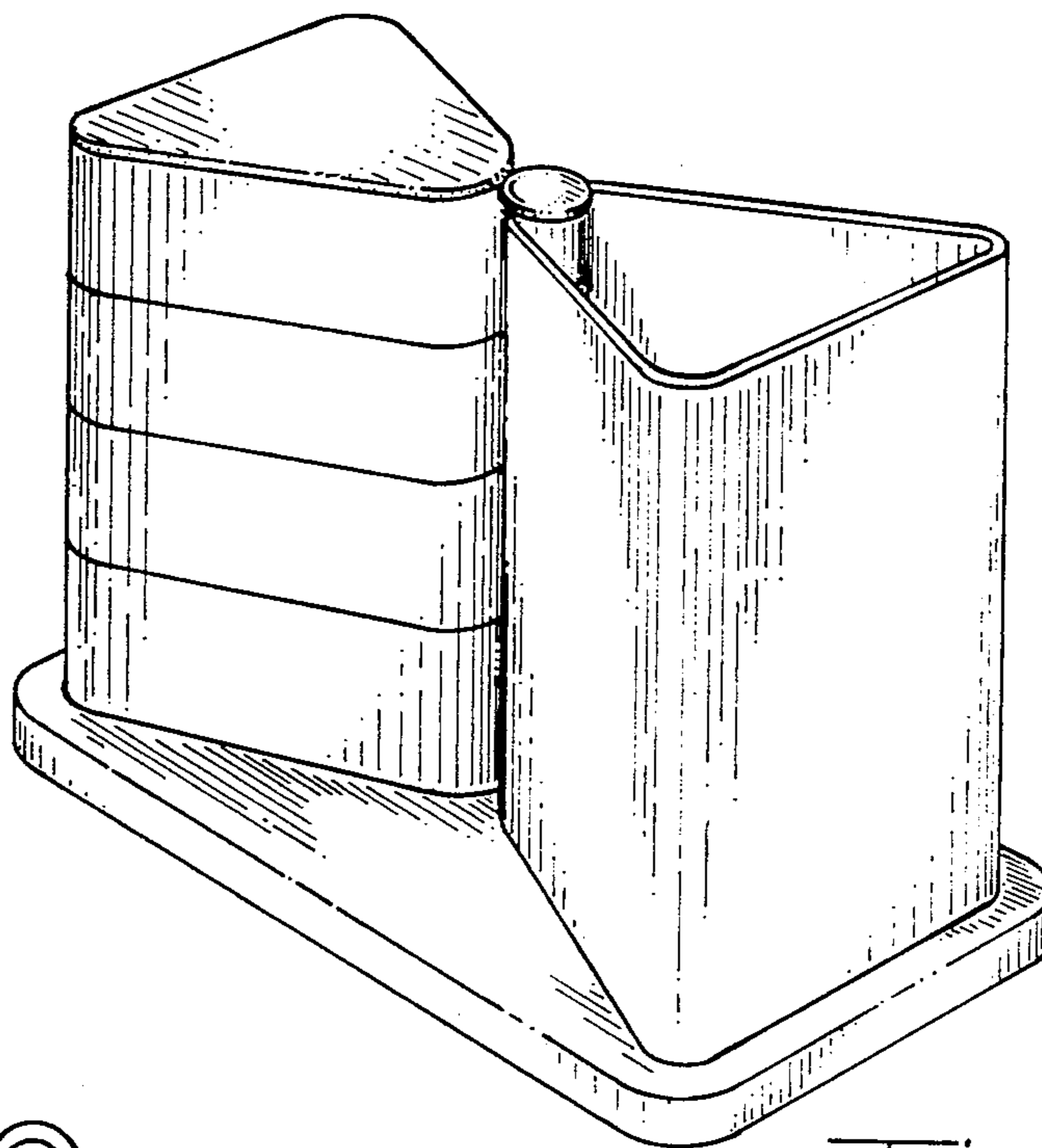

Fig. 7

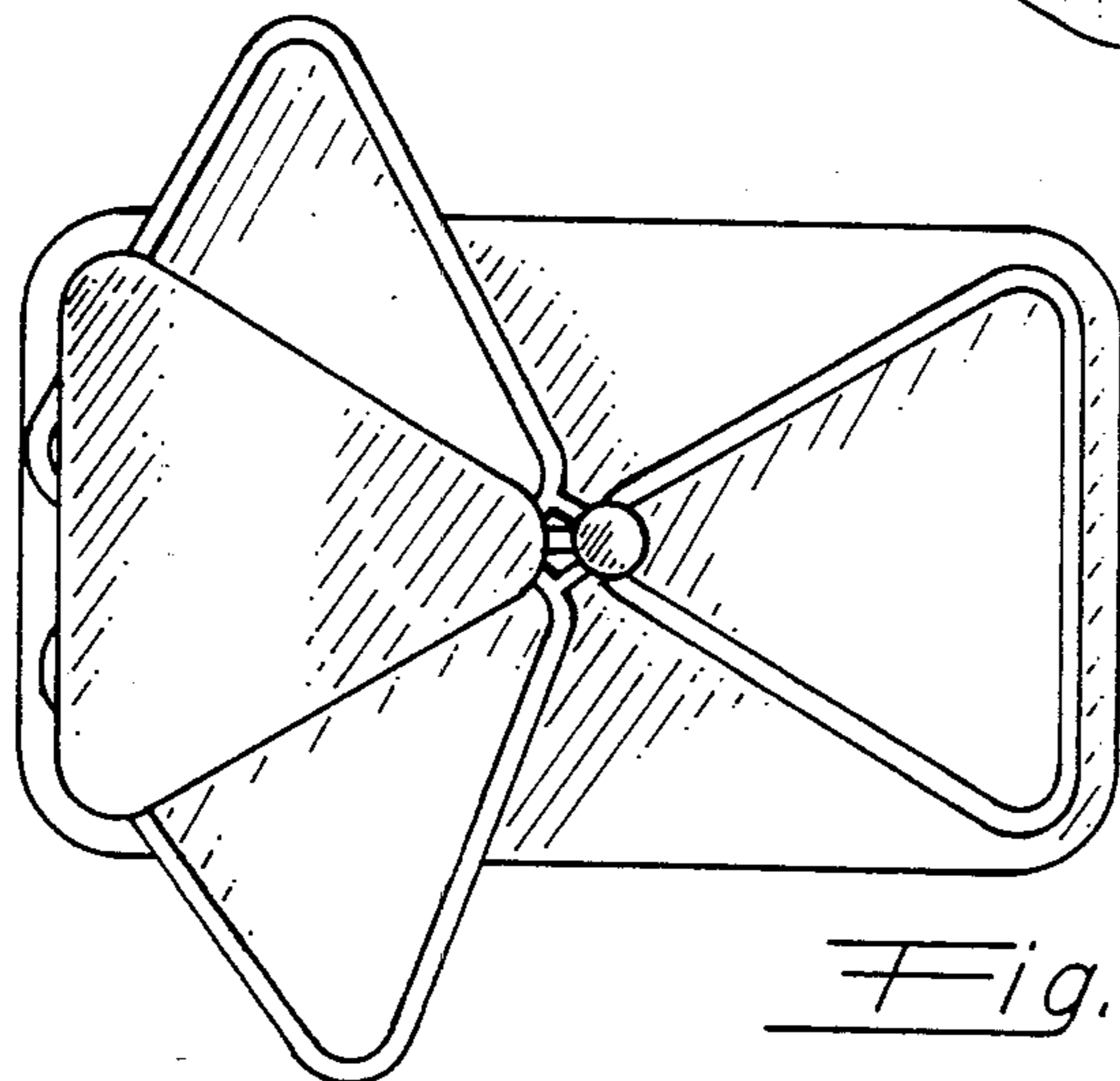

Fig. 8