

United States Patent [19]

Krammer

[11] Patent Number: **Des. 280,728**

[45] Date of Patent: **** Sep. 24, 1985**

[54] **CULTIVATOR BLADE**

[76] Inventor: **Kelly A. Krammer**, P.O. Box 144,
Cupar, Saskatchewan, Canada, S0G
0Y0

[**] Term: **14 Years**

[21] Appl. No.: **516,960**

[22] Filed: **Jul. 25, 1983**

Related U.S. Application Data

[63] Continuation-in-part of Ser. No. 289,161, Aug. 3, 1981,
Pat. No. Des. 274,187.

Foreign Application Priority Data

Jan. 28, 1983 [CA] Canada 28-01-83-3

[52] U.S. Cl. **D15/11; D8/11;**
D15/29

[58] Field of Search D8/11; D15/10, 11, 28,
D15/29; 172/720, 721, 724, 730, 765, 770, 771

References Cited

U.S. PATENT DOCUMENTS

447,305 3/1891 Fish 172/730

1,659,944	9/1928	Some	D8/11
2,704,499	3/1955	Radway	172/720
3,923,104	12/1975	Tibbs	172/730
4,175,341	11/1979	Mortimore	172/721

OTHER PUBLICATIONS

Implement & Tractor, 12, 1983, p. ME-4, Kelly Shovel,
Kelly 11, located upper left corner.

Primary Examiner—B. J. Bullock

Assistant Examiner—Suzanne N. Gitlin

[57] CLAIM

The ornamental design for a cultivator blade, as shown
and described.

DESCRIPTION

FIG. 1 is a perspective view of a cultivator blade showing my new design;
 FIG. 2 is a front elevational view thereof;
 FIG. 3 is a side elevational view taken from the left of FIG. 1;
 FIG. 4 is a side elevational view taken from the right of FIG. 1;
 FIG. 5 is a rear elevational view thereof;
 FIG. 6 is a top plan view thereof; and
 FIG. 7 is a bottom plan view thereof.

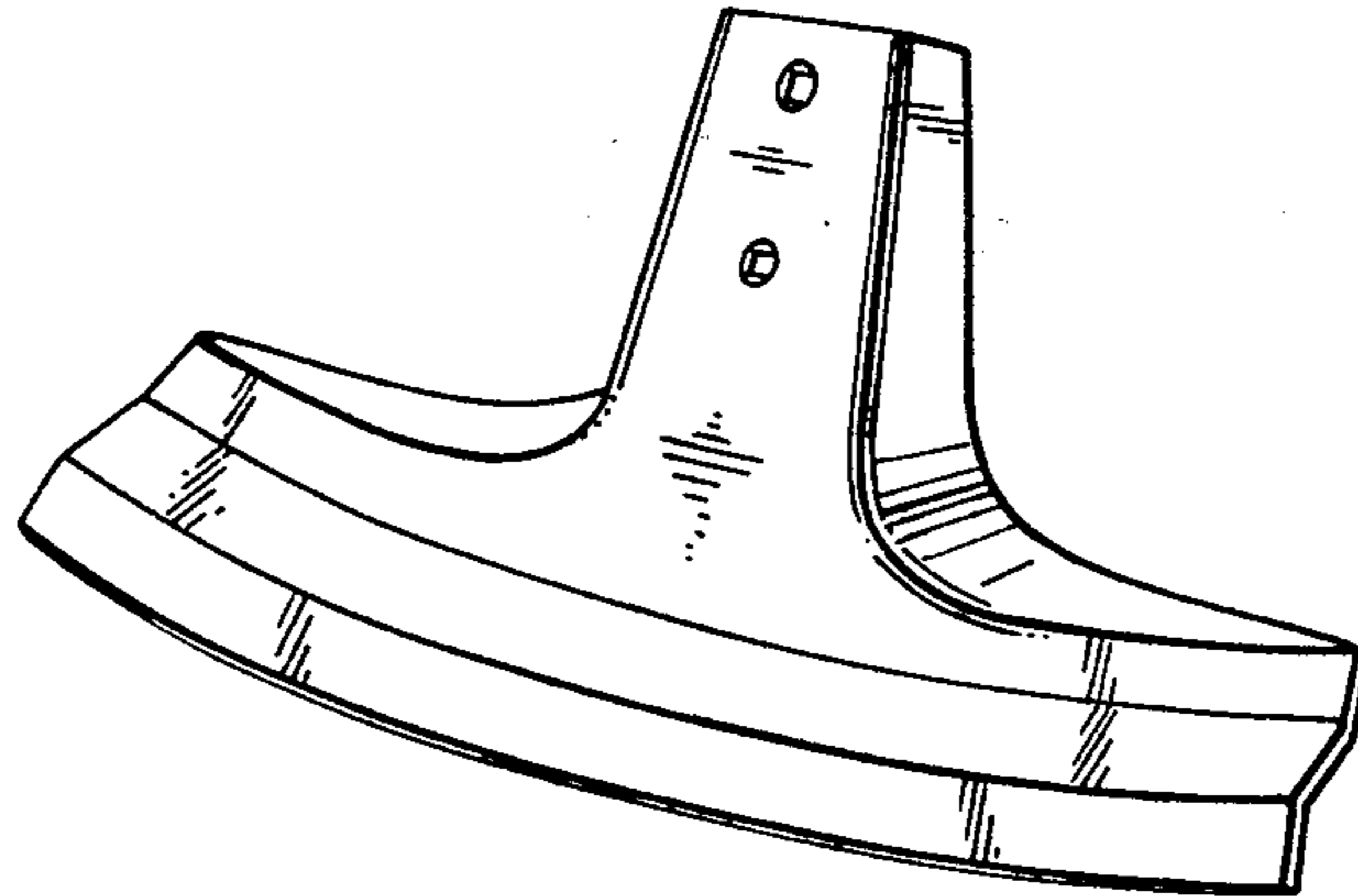

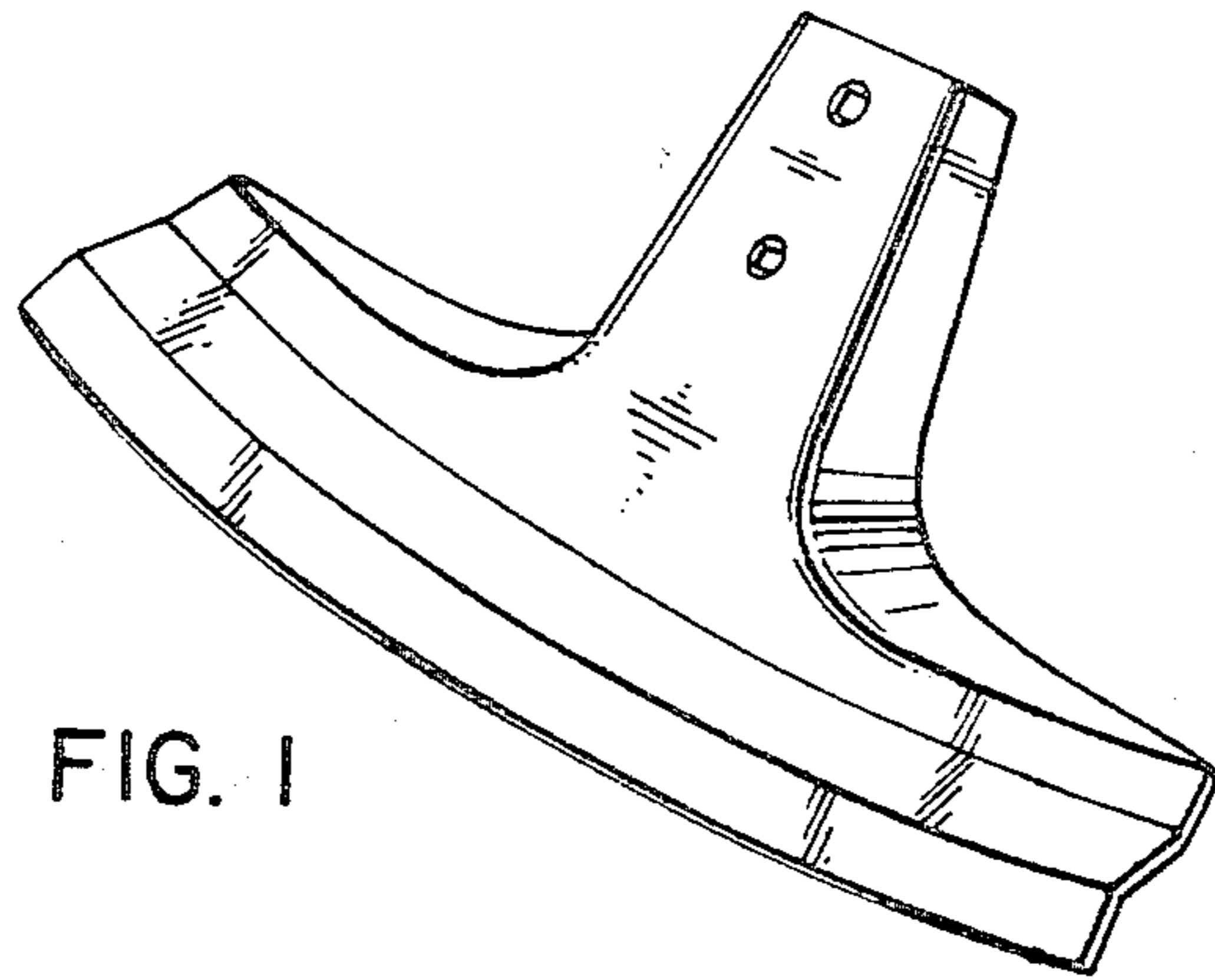

FIG. 1

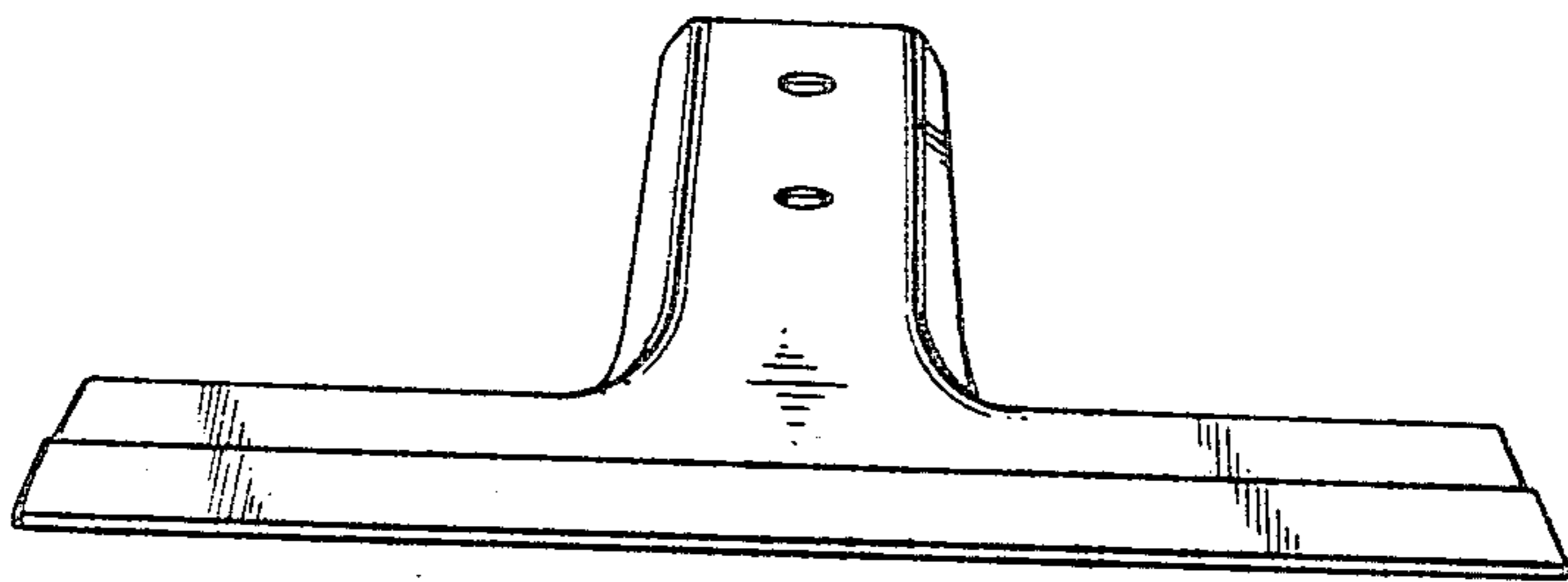

FIG. 2

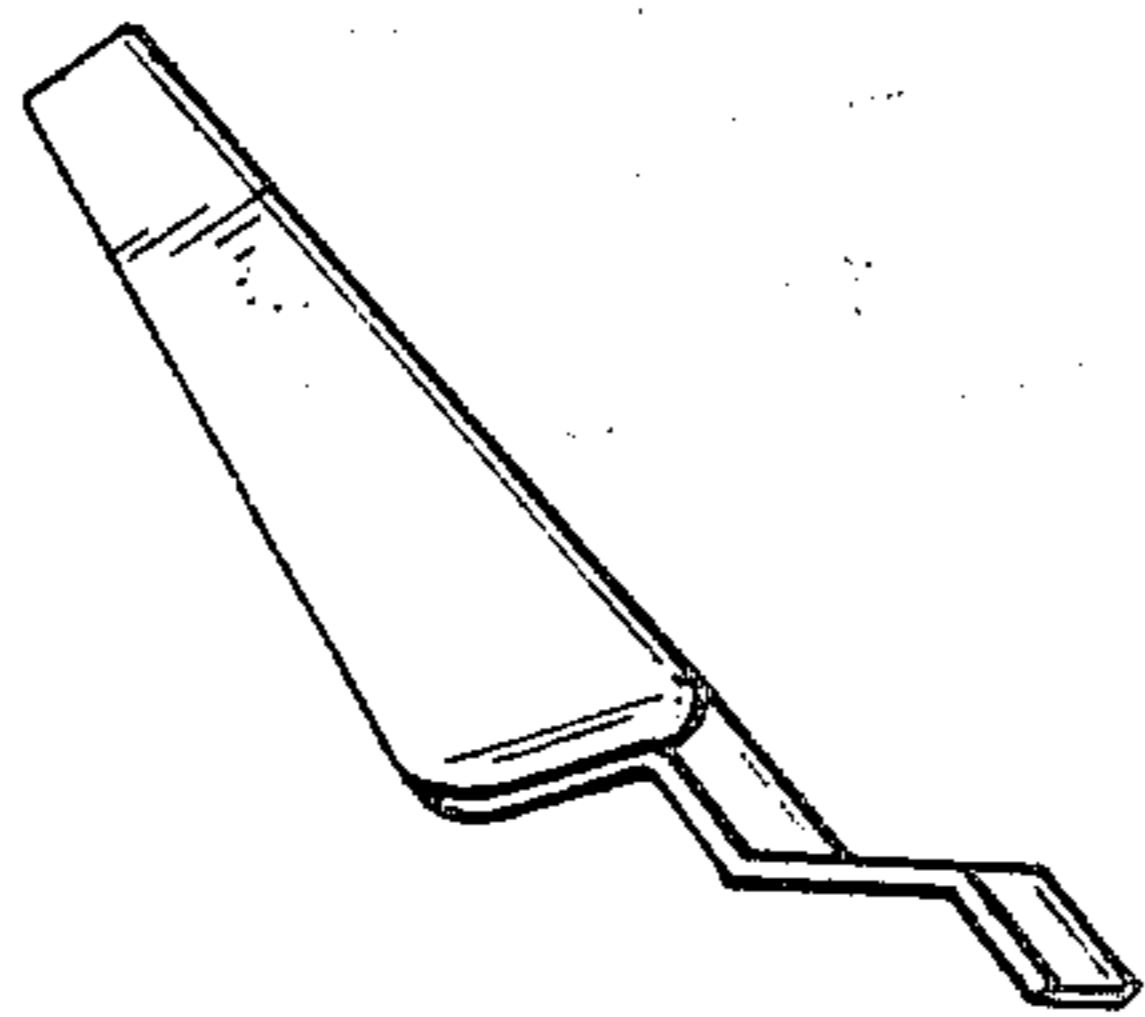

FIG. 3

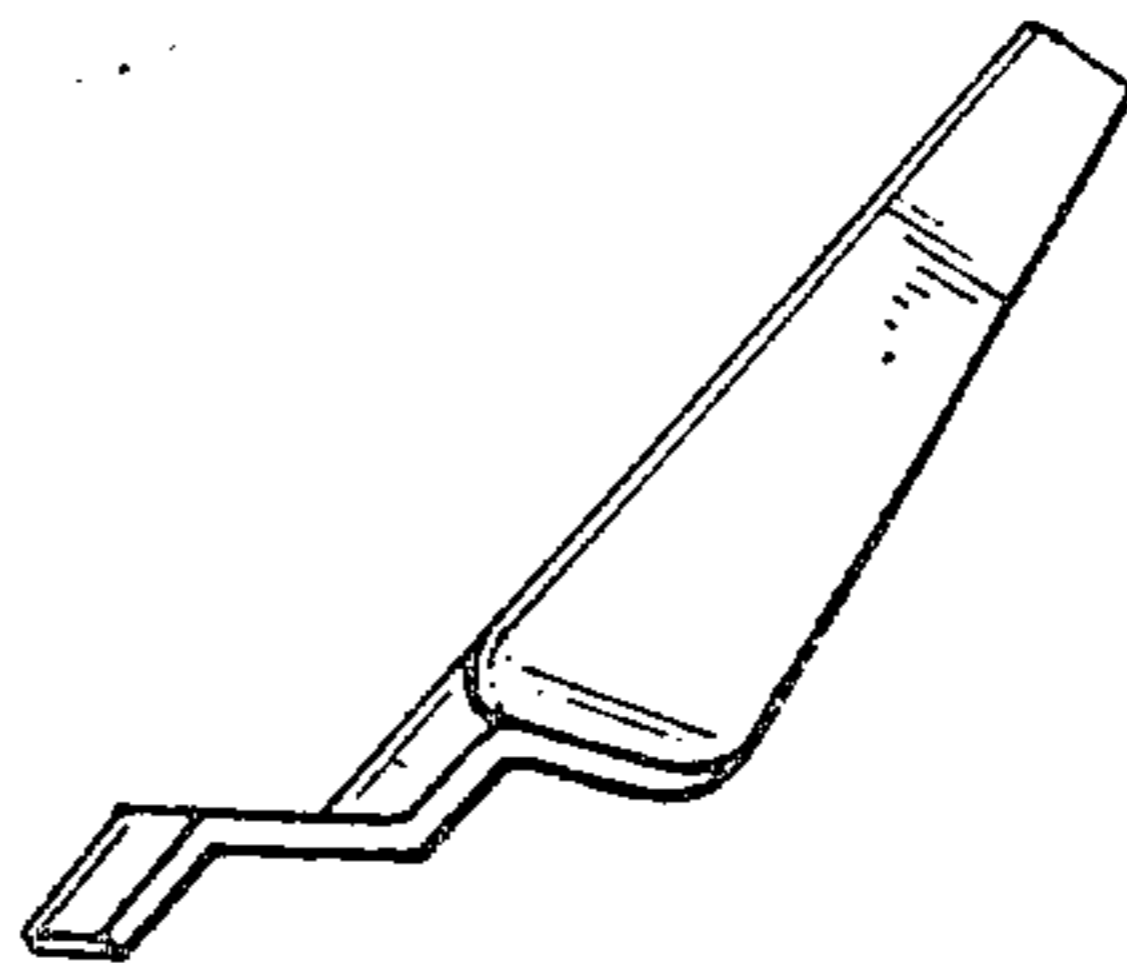

FIG. 4

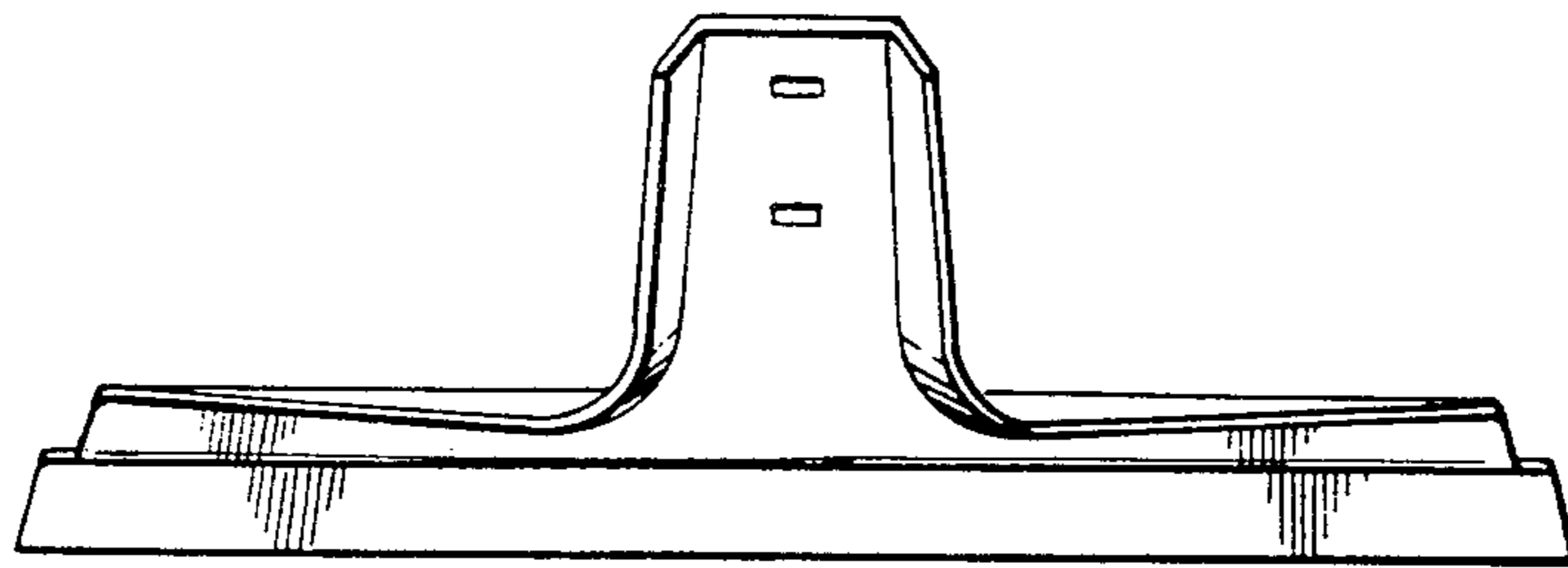

FIG. 5

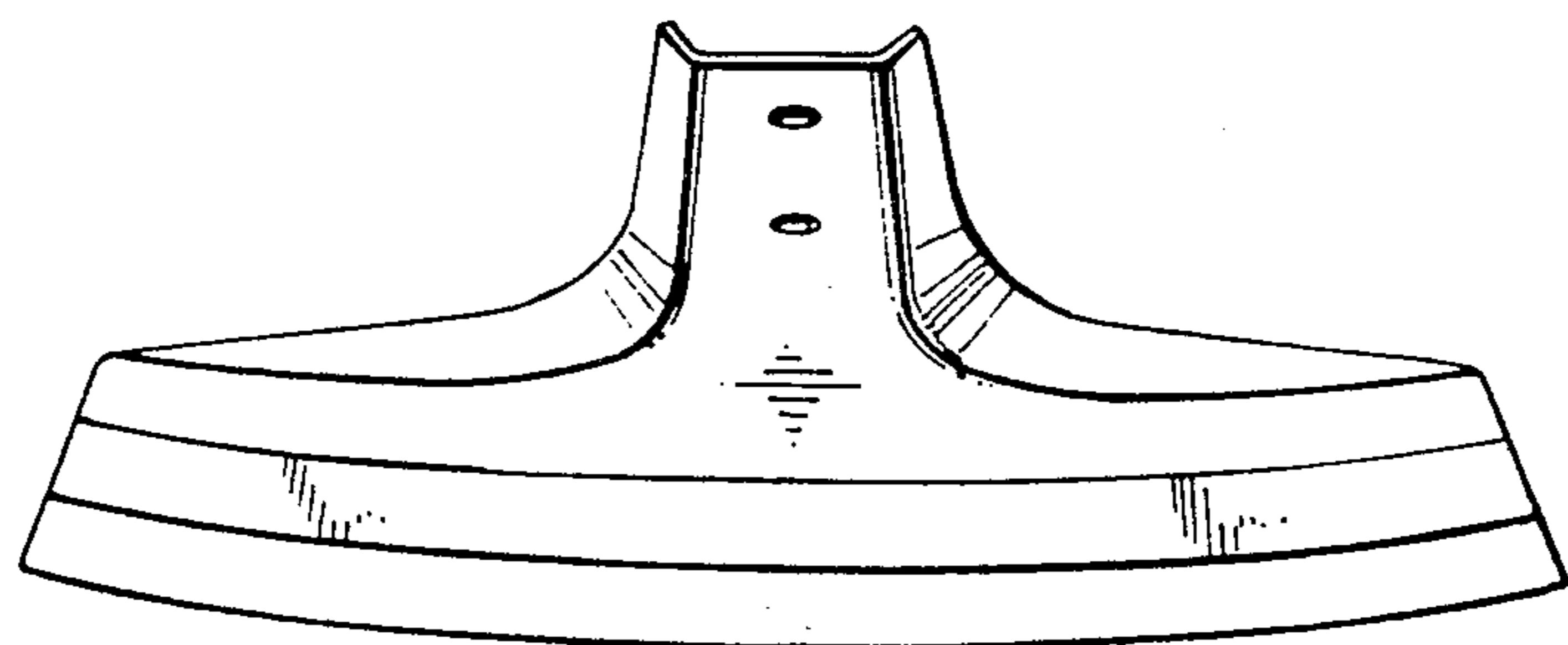

FIG. 6

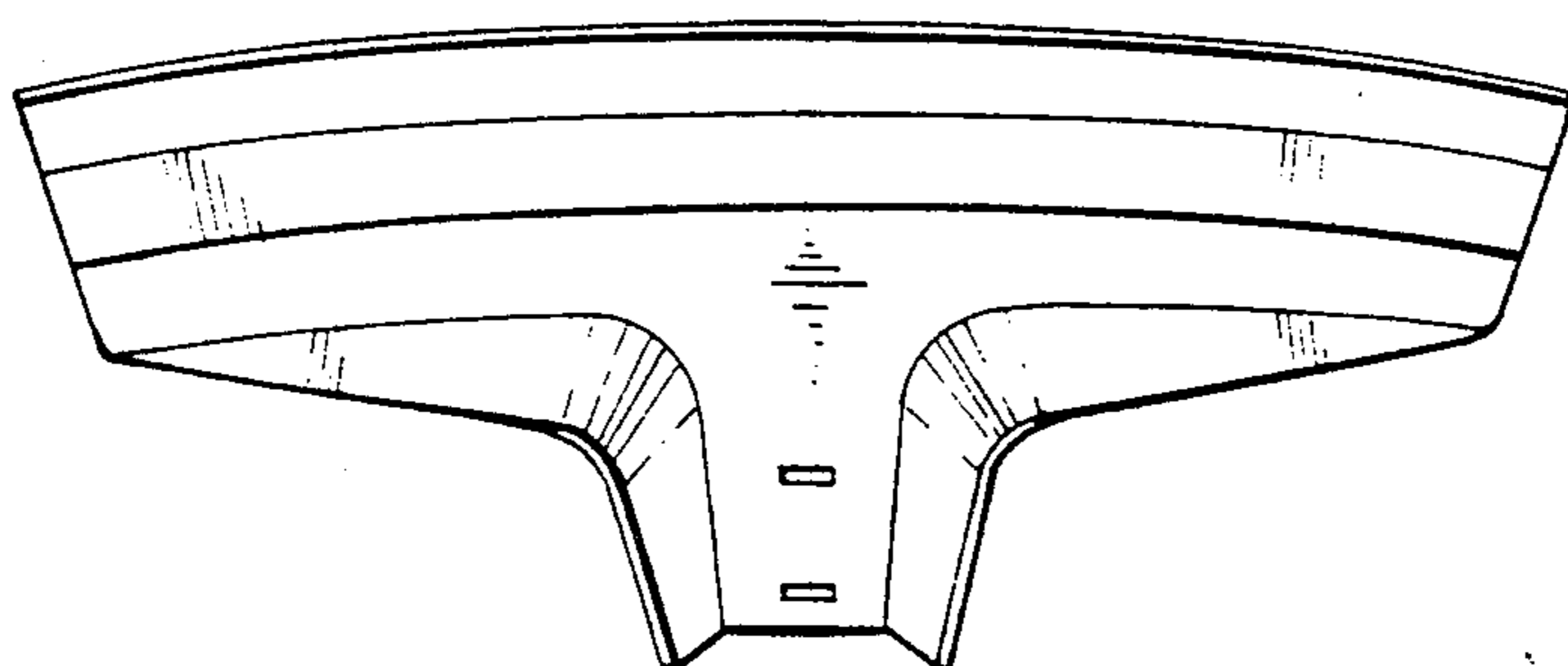

FIG. 7