

[54] **TOGGLE SWITCH**

[76] **Inventor:** Shigeo Ohashi, c/o Nihon Kaiheiki
Kogyo Kabushiki Kaisha, 5-14
Minamimagome 1-chome, Ohta-ku,
Tokyo, Japan

[**] **Term:** 14 Years

[21] **Appl. No.:** 549,765

[22] **Filed:** Nov. 8, 1983

[30] **Foreign Application Priority Data**

Mar. 14, 1983 [JP] Japan 58-010498

[52] **U.S. Cl.** D13/37

[58] **Field of Search** D13/32, 33, 37, 38;
200/5 R, 5 A, 6 R, 6 A, 293, 295, 296, 302, 303,
155 R, 159 R

[56] **References Cited**

U.S. PATENT DOCUMENTS

D. 224,015 6/1972 Nakata D13/37
D. 254,848 4/1980 Sano D13/37
D. 268,838 5/1983 Ohashi D13/37

D. 268,927 5/1983 Ohashi D13/38
3,169,172 2/1965 Hagberg 200/5 R

FOREIGN PATENT DOCUMENTS

1244088 9/1960 France 200/5 R

Primary Examiner—Wallace R. Burke

Assistant Examiner—Lynn Wilder

[57] **CLAIM**

The ornamental design for a toggle switch, substantially as shown and described.

DESCRIPTION

FIG. 1 is a front elevational view of a toggle switch showing my new design;

FIG. 2 is a rear elevational view thereof;

FIG. 3 is a top plan view thereof;

FIG. 4 is a bottom plan view thereof;

FIG. 5 is a left side elevational view thereof;

FIG. 6 is a right side elevational view thereof;

FIG. 7 is an enlarged cross-sectional view of the switch taken along line 7—7 of FIG. 3;

FIG. 8 is a perspective view thereof.

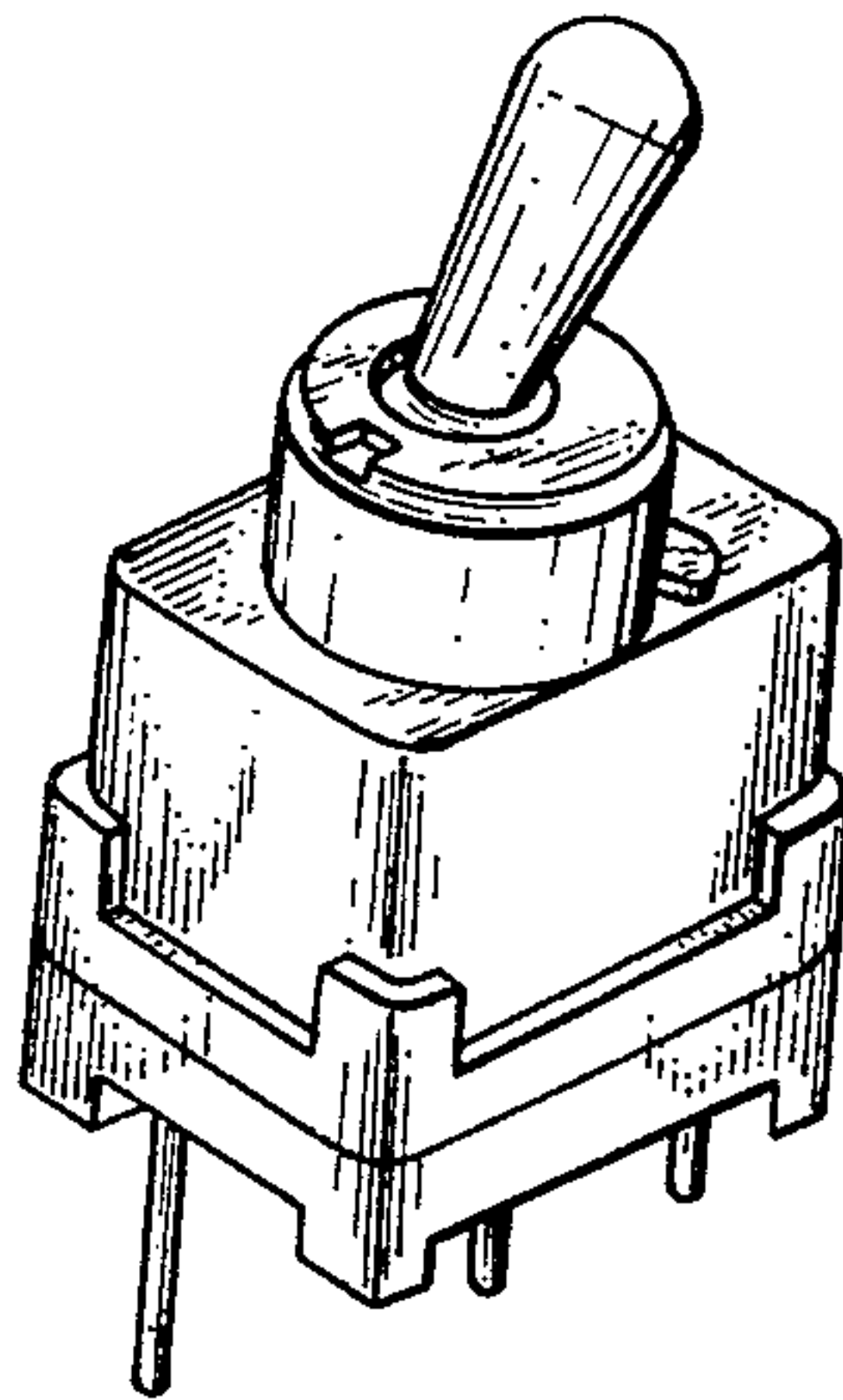

FIG. 1

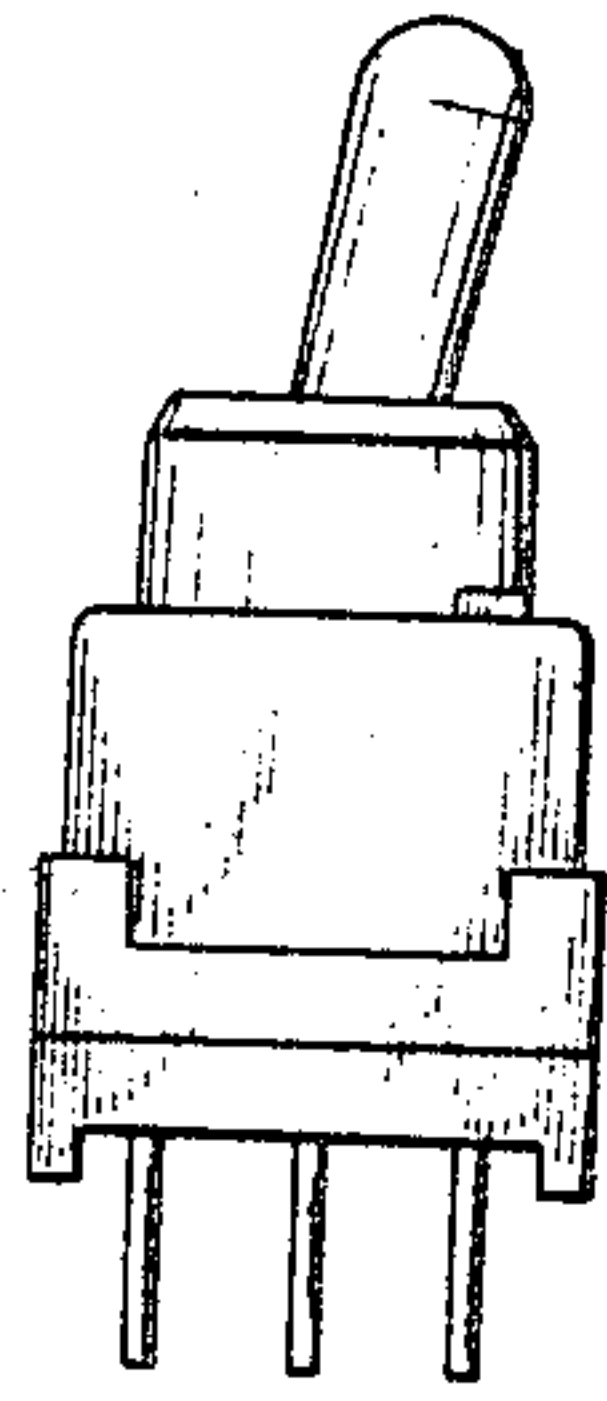

FIG. 2

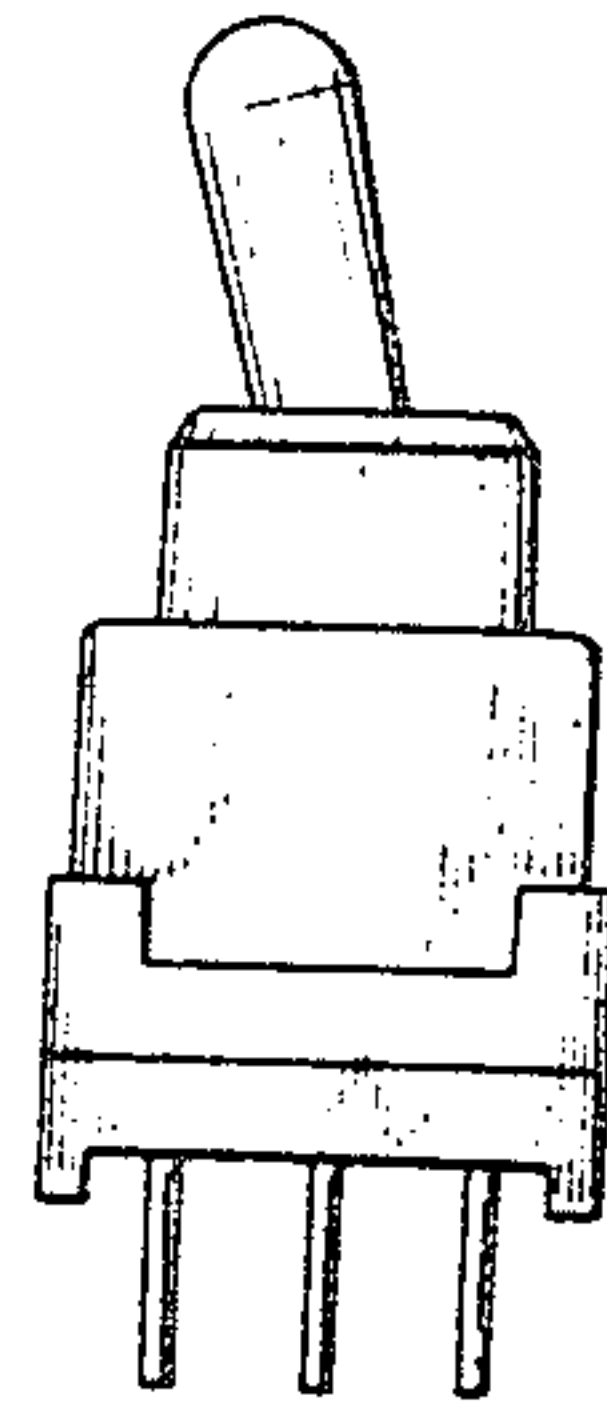

FIG. 3

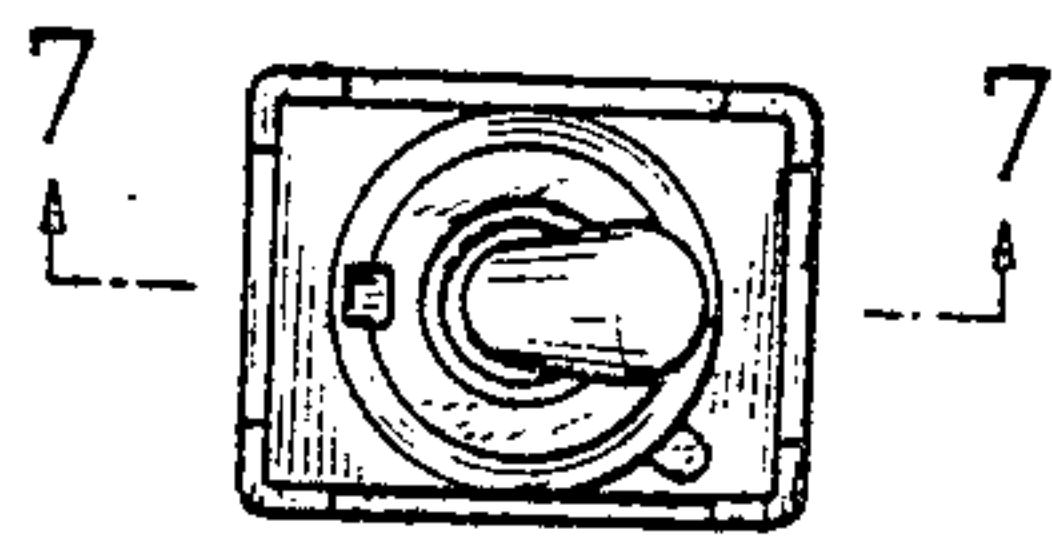

FIG. 4

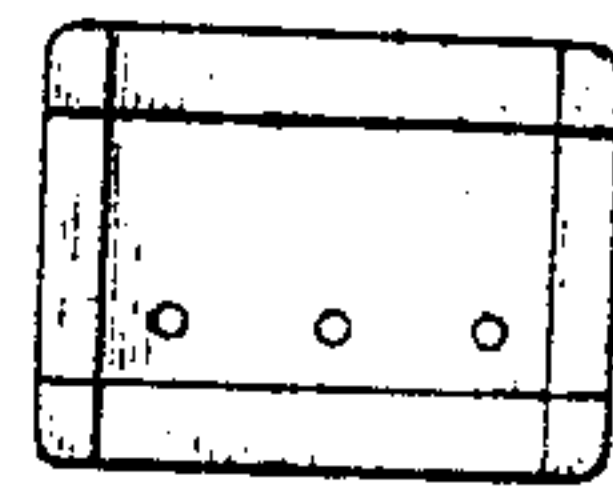

FIG. 5

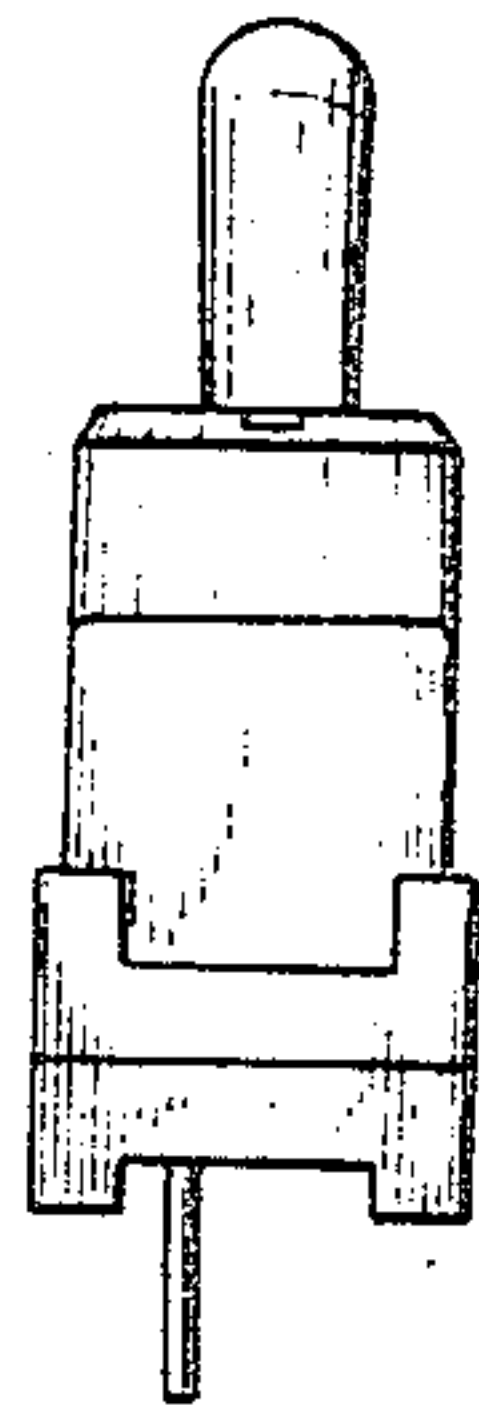

FIG. 6

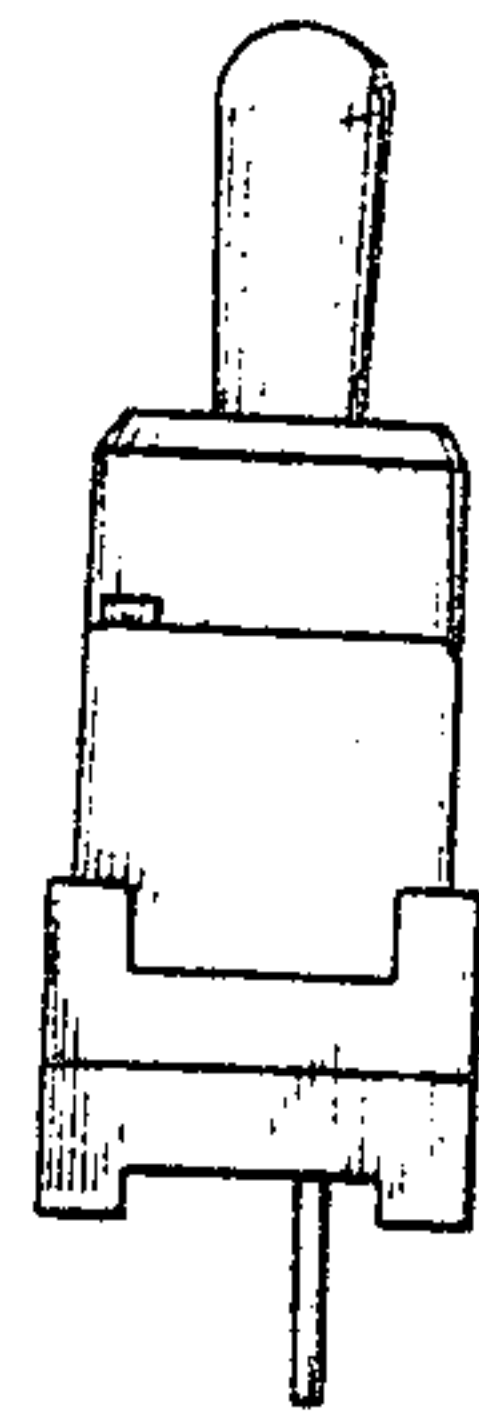

FIG. 7

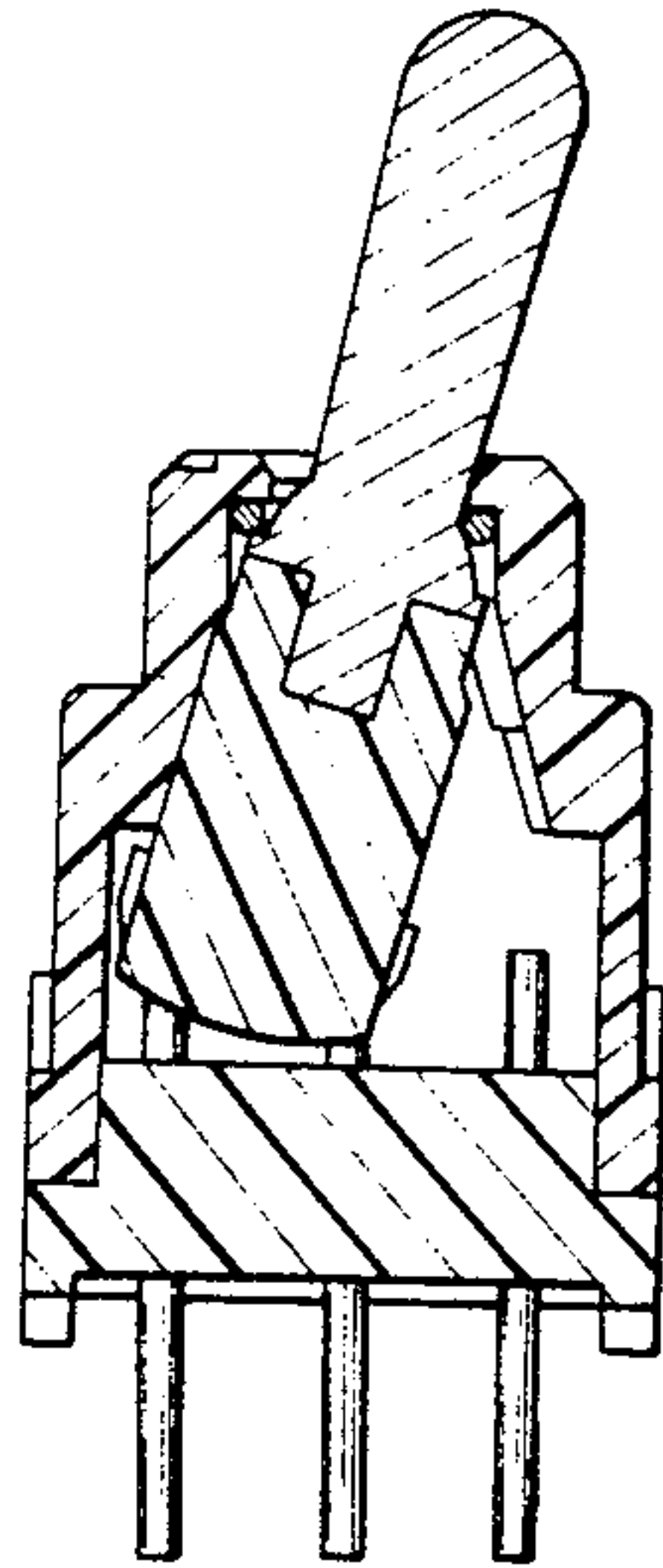

FIG. 8

