

[54] TOGGLE SWITCH

[75] Inventor: Shigeo Ohashi, Tokyo, Japan

[73] Assignee: Nihon Kaikeiki Kogyo Kabushiki Kaisha, Japan

[**] Term: 14 Years

[21] Appl. No.: 549,764

[22] Filed: Nov. 8, 1983

[30] Foreign Application Priority Data

Mar. 14, 1983 [JP] Japan 58-010499

[52] U.S. Cl. D13/37

[58] Field of Search D13/32, 33, 37, 38; 200/5 R, 5 A, 6 R, 6 A, 293, 295, 296, 302, 303, 155 R, 159 R

[56] References Cited

U.S. PATENT DOCUMENTS

- D. 224,015 6/1972 Nakata D13/37
- D. 254,848 4/1980 Sano D13/37
- D. 268,838 5/1983 Ohashi D13/37

- D. 268,927 5/1983 Ohashi D13/38
- 3,169,172 2/1965 Hagberg 200/5 R

FOREIGN PATENT DOCUMENTS

- 1244088 9/1960 France 200/5 R

Primary Examiner—Wallace R. Burke
Assistant Examiner—Lynn Wilder
Attorney, Agent, or Firm—Steinberg & Raskin

[57] CLAIM

The ornamental design for a toggle switch, substantially as shown and described.

DESCRIPTION

FIG. 1 is a front elevational view of a toggle switch showing my new design;
FIG. 2 is a rear elevational view thereof;
FIG. 3 is a top plan view thereof;
FIG. 4 is a bottom plan view thereof;
FIG. 5 is a left side elevational view thereof;
FIG. 6 is a right side elevational view thereof;
FIG. 7 is an enlarged cross-sectional view of the switch taken along line 7—7 of FIG. 3;
FIG. 8 is a perspective view thereof.

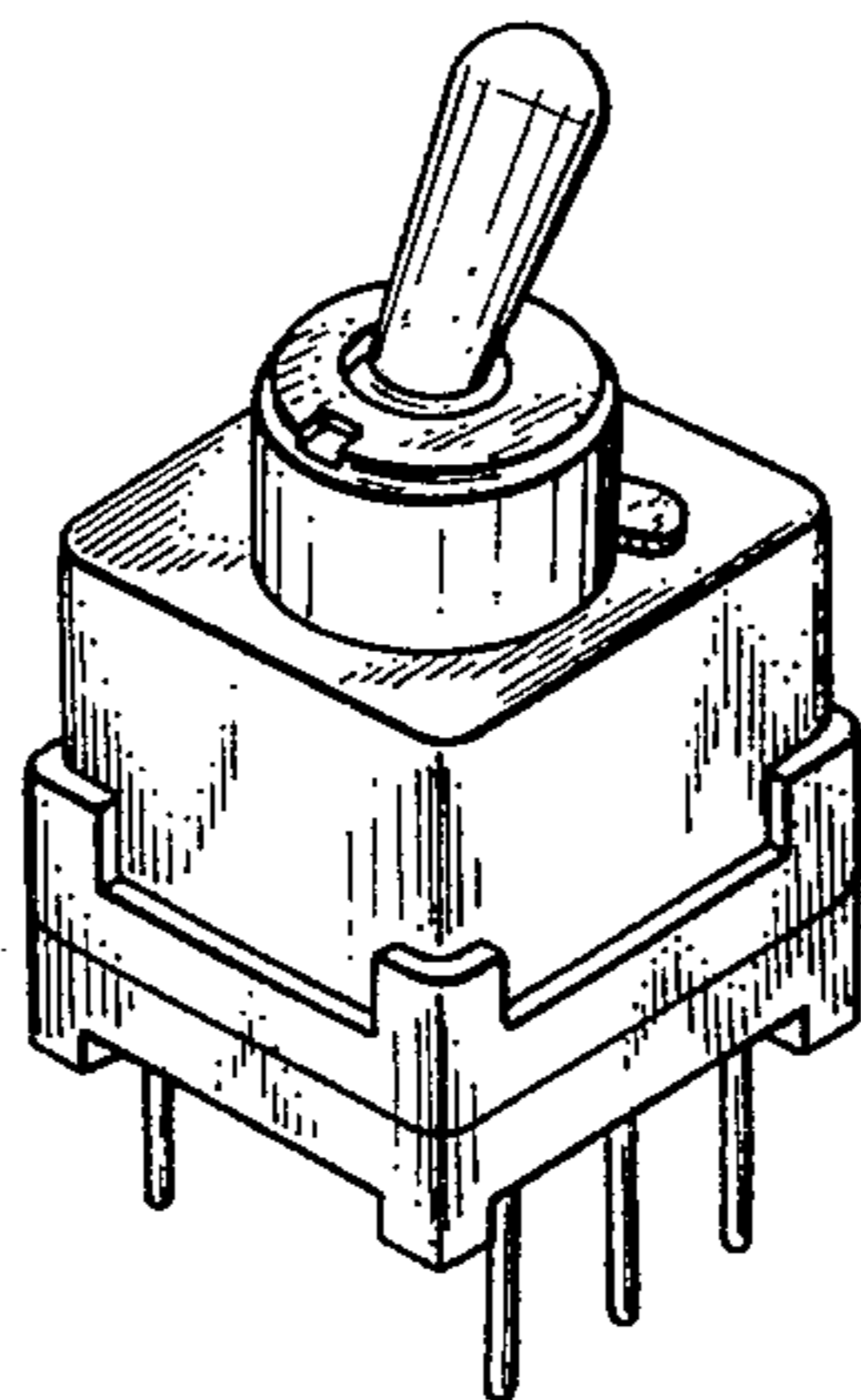

FIG. 1

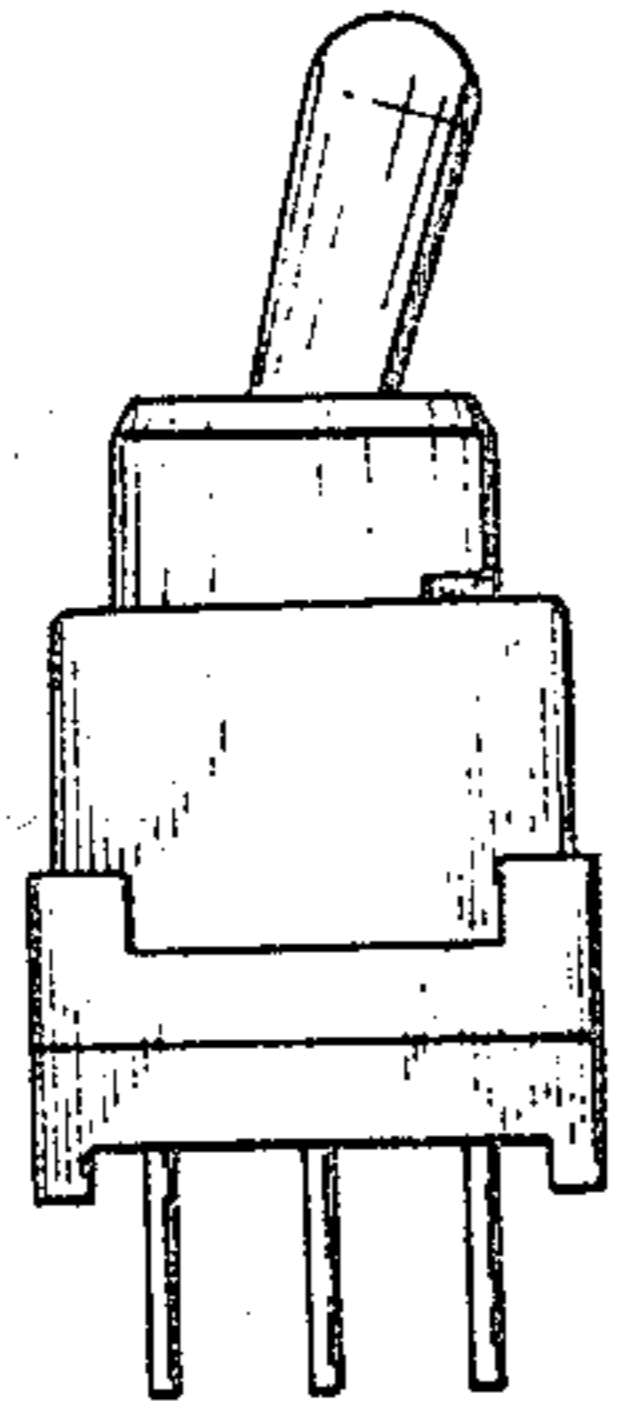

FIG. 2

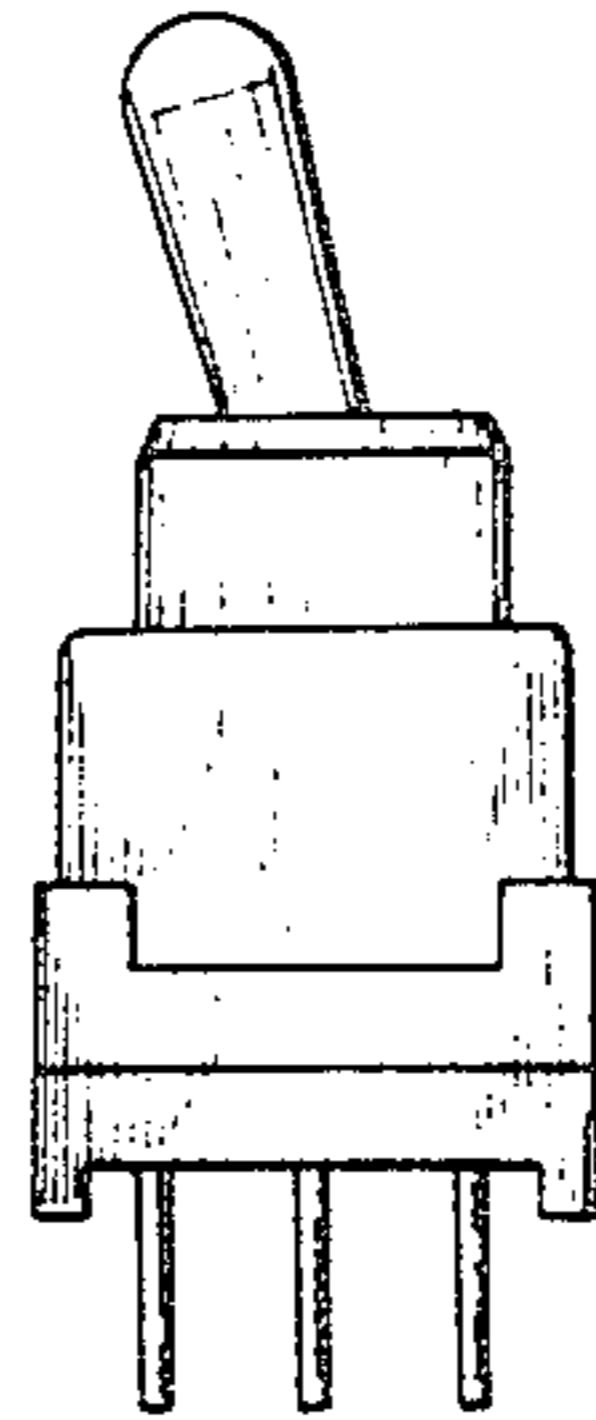

FIG. 3

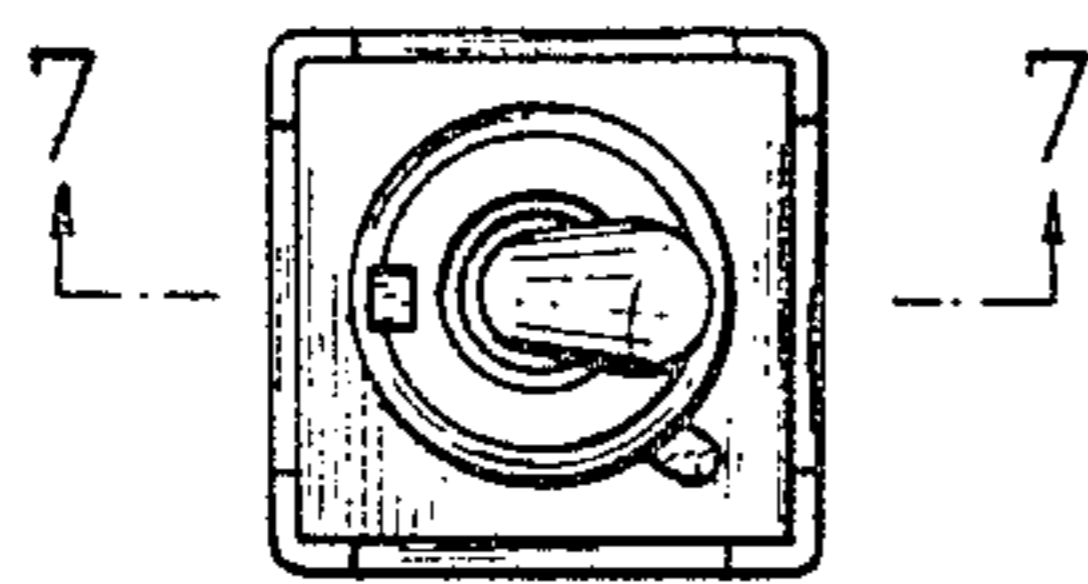

FIG. 4

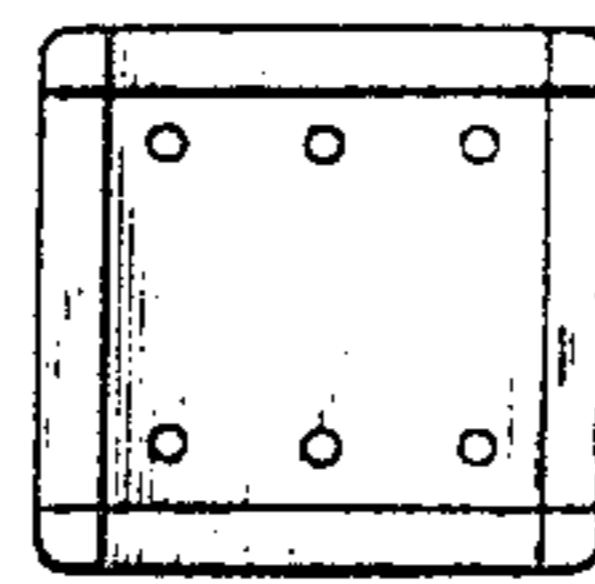

FIG. 5

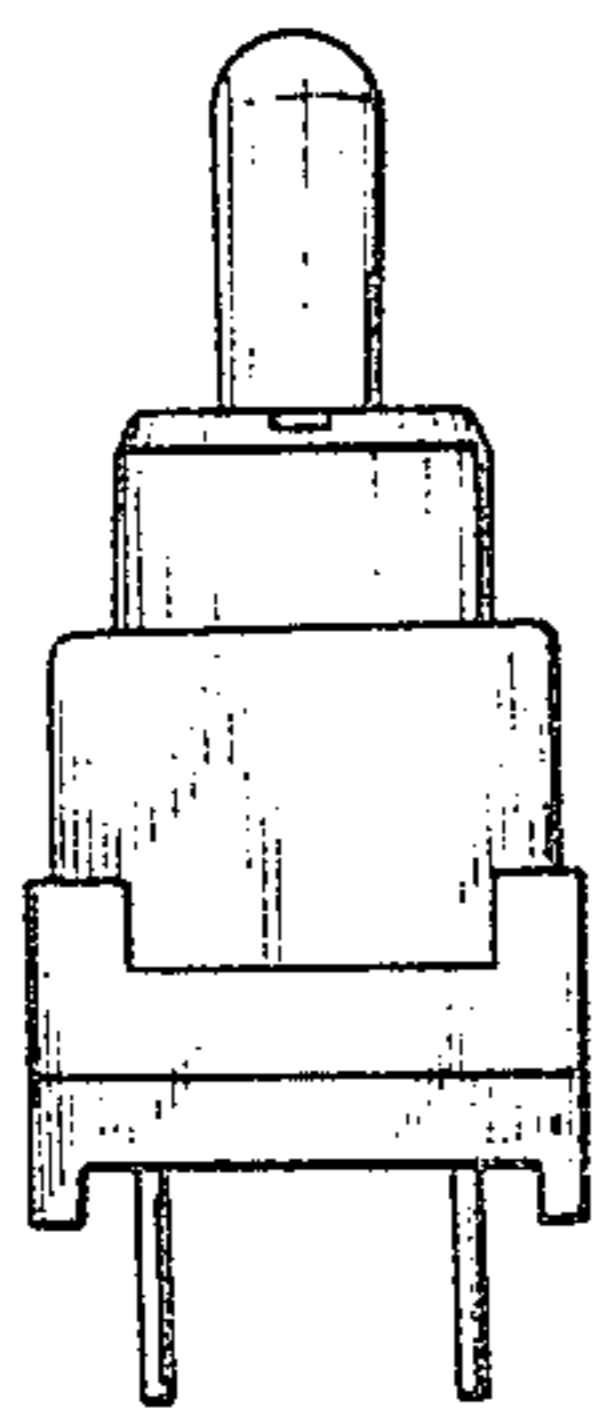

FIG. 6

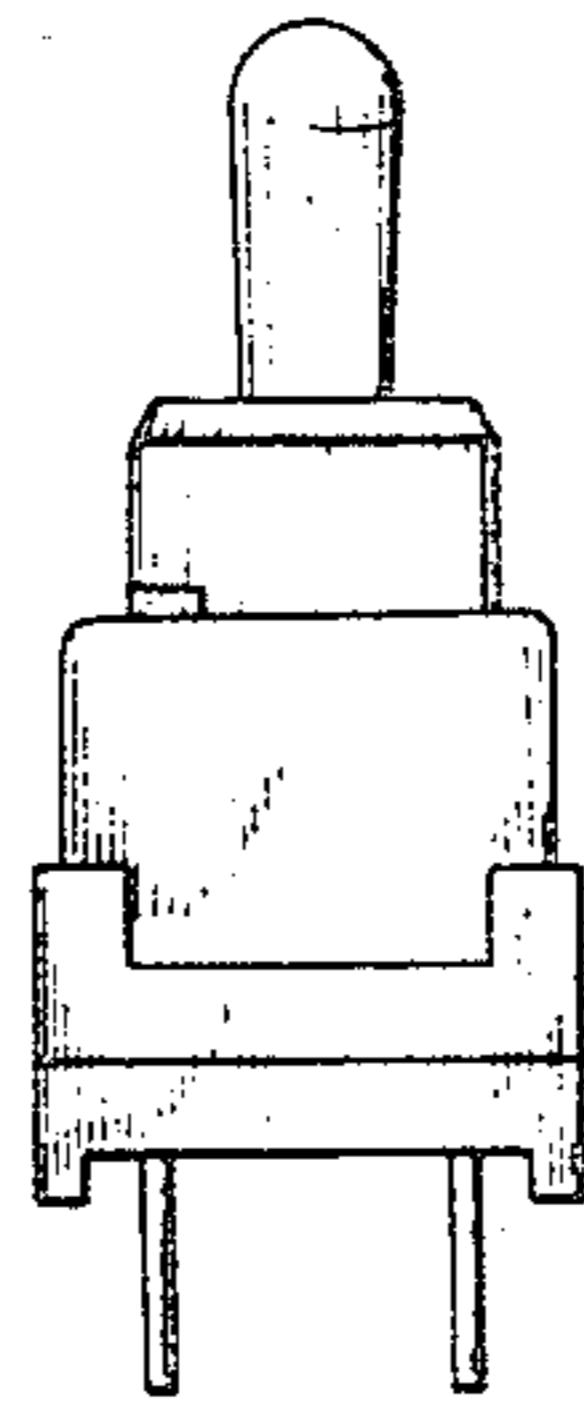

FIG. 7

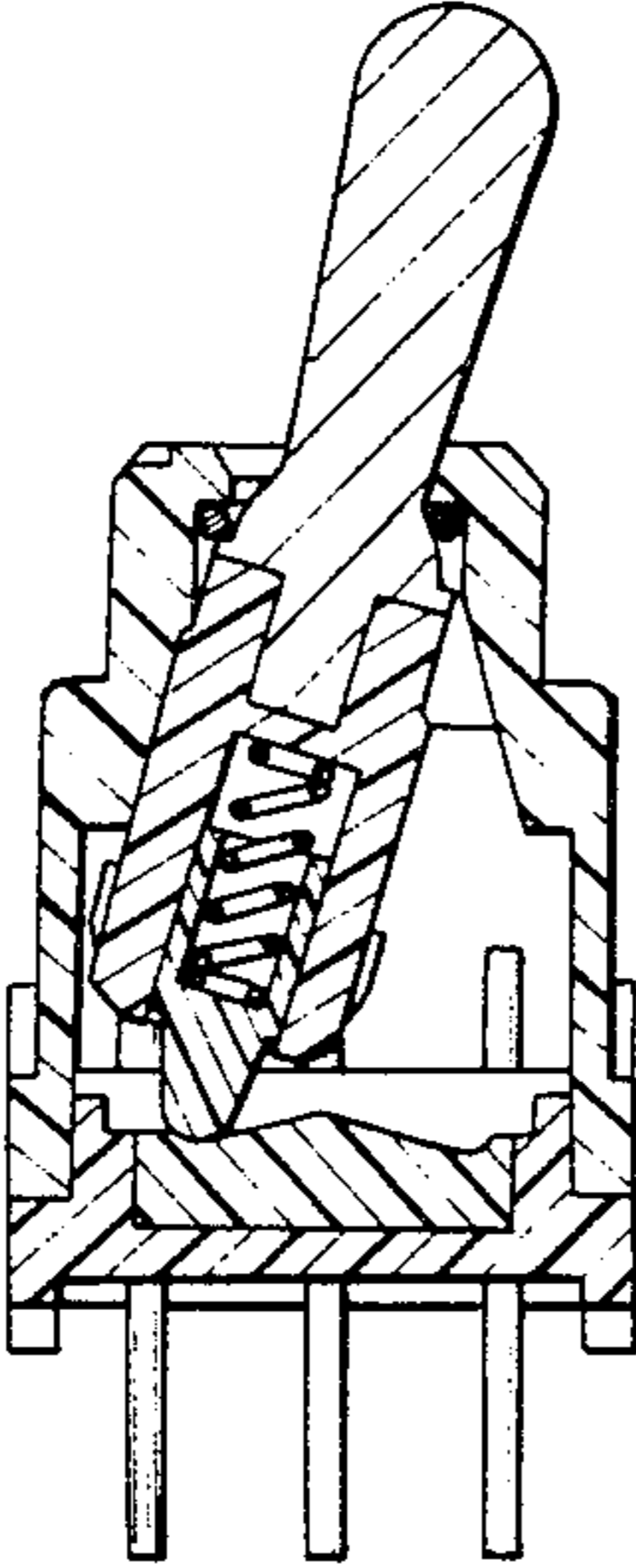

FIG. 8

