

FIG. 4

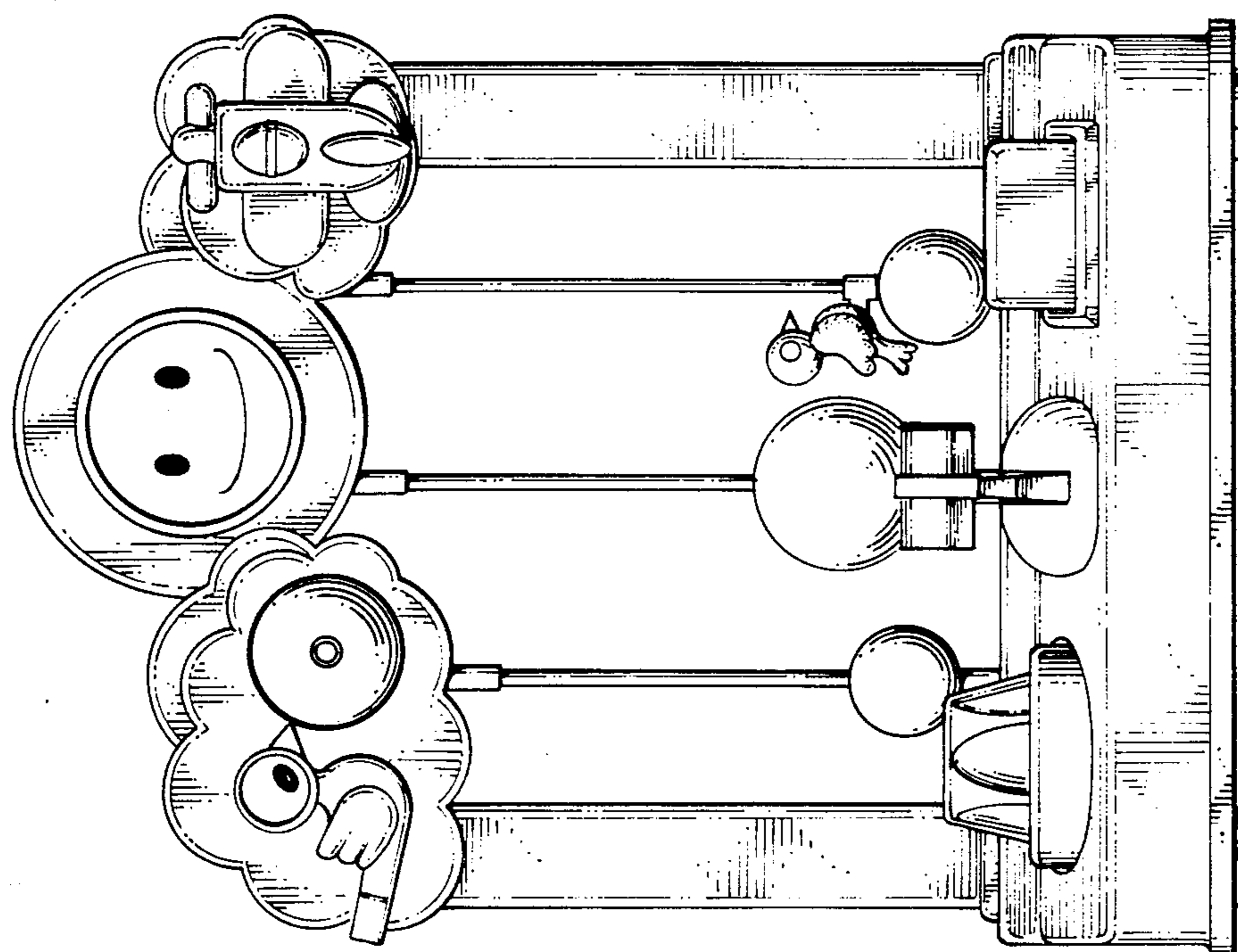

FIG. 3

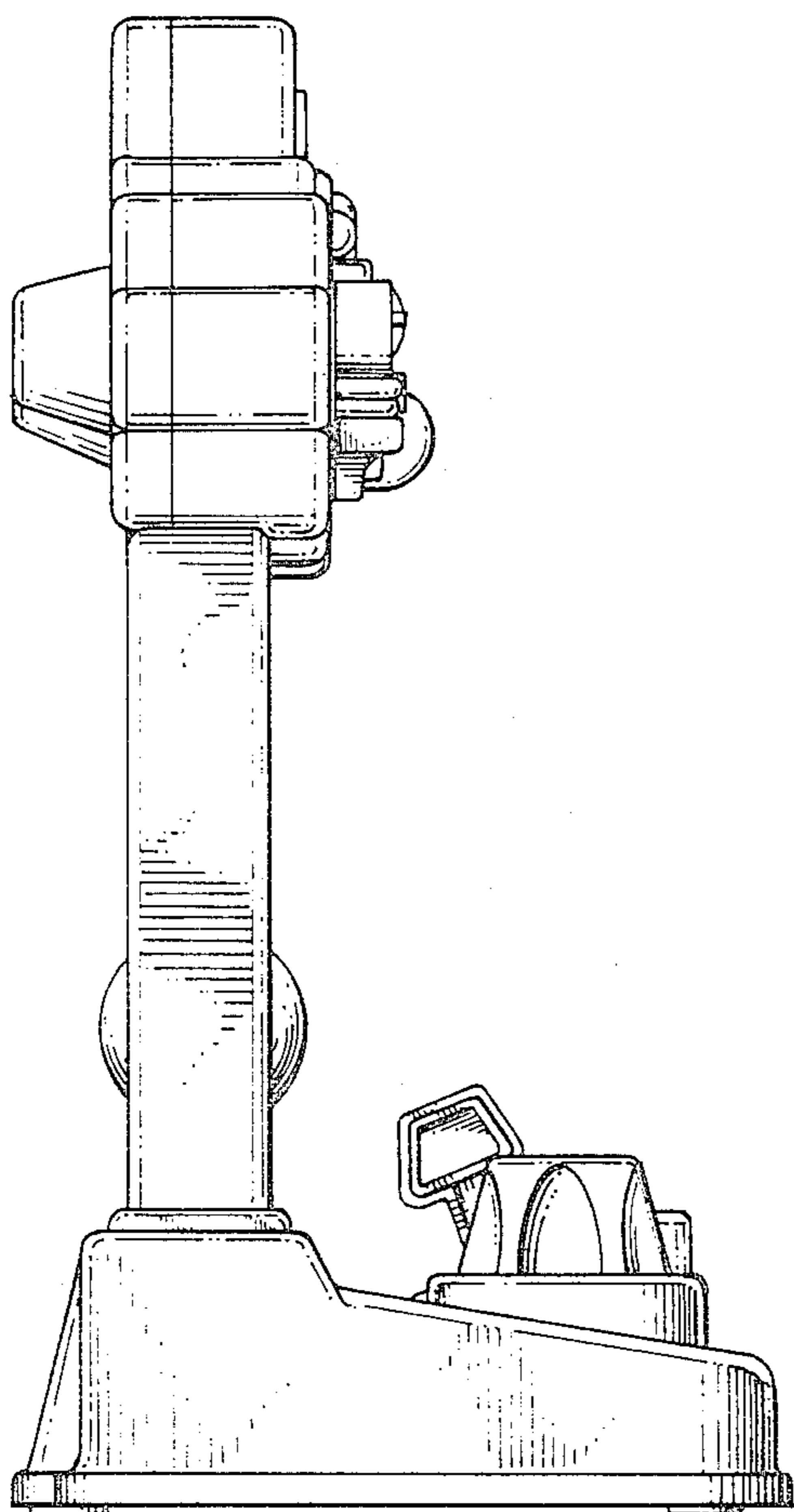

FIG. 5

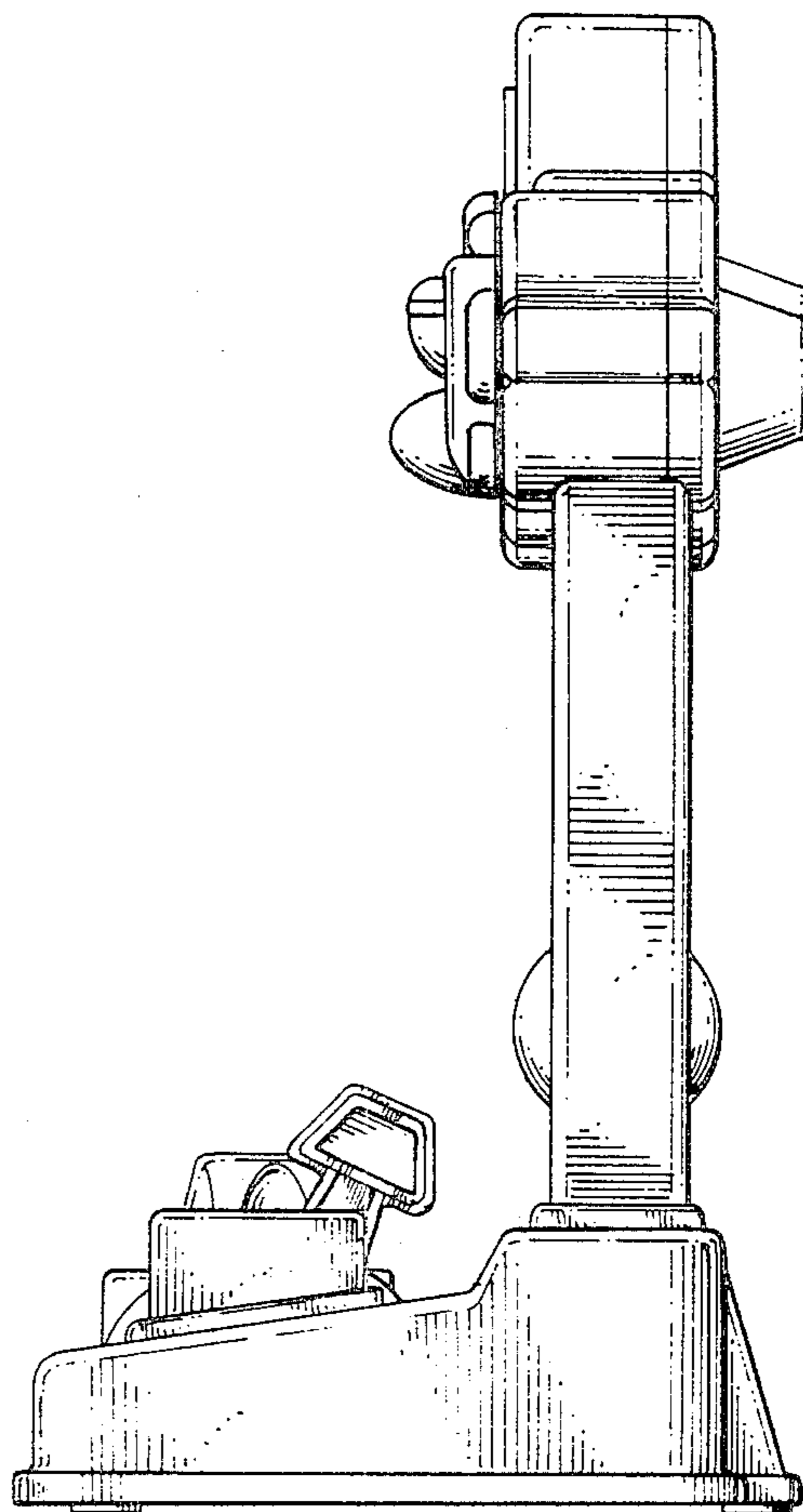

FIG. 6

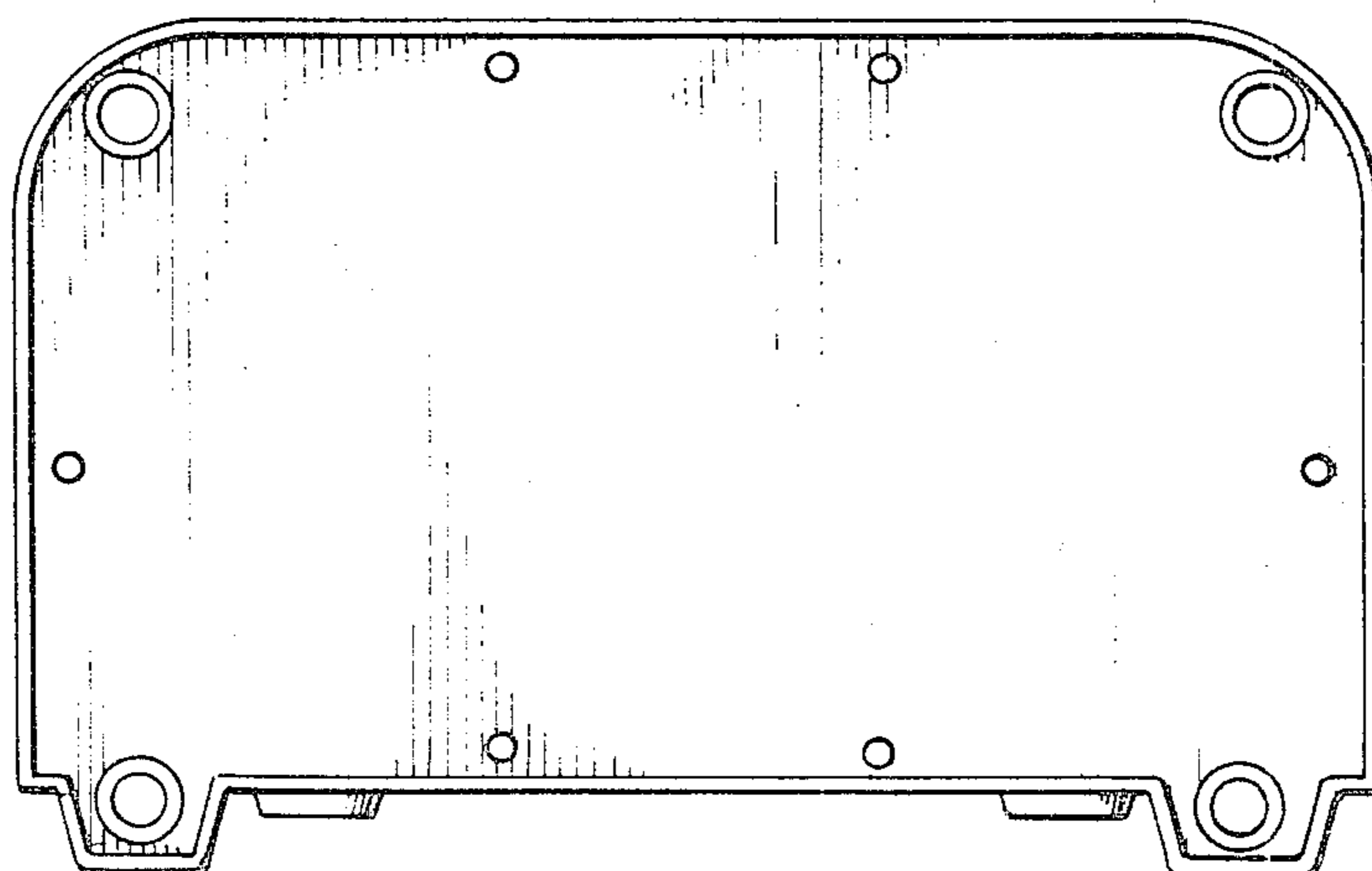

FIG. 7

[54] **ACTIVITY TOY**

[75] Inventor: **Tomoaki Kodama**, Tokyo, Japan

[73] Assignee: **Kawada Co., Ltd.**, Tokyo, Japan

[**] Term: **14 Years**

[21] Appl. No.: **532,780**

[22] Filed: **Sep. 16, 1983**

[30] **Foreign Application Priority Data**

Jun. 15, 1983 [JP] Japan 58-25474

[52] U.S. Cl. **D21/64; D21/59**

[58] Field of Search D21/59, 63, 64, 65;
D19/59, 60, 62, 64; 434/258, 259, 260; 446/227,
236, 396, 404, 489, 490

[56] **References Cited**

U.S. PATENT DOCUMENTS

- D. 187,218 2/1960 McHugh D19/59
- D. 214,065 5/1969 Campbell D21/59

- D. 264,104 4/1982 Gompes D21/65
- D. 276,056 10/1984 Chatani D21/63
- 1,665,578 4/1928 Becker D21/64

OTHER PUBLICATIONS

Playthings, 9-1982, p. 49, "Pop-Up Songbirds".

Primary Examiner—Charles A. Rademaker
Attorney, Agent, or Firm—Don B. Finkelstein

[57] **CLAIM**

The ornamental design for an activity toy, substantially as shown and described.

DESCRIPTION

FIG. 1 is a perspective view of an activity toy showing my new design;
 FIG. 2 is a top plan view thereof;
 FIG. 3 is a front elevational view thereof;
 FIG. 4 is a rear elevational view thereof;
 FIG. 5 is a left side elevational view thereof;
 FIG. 6 is a right side elevational view thereof; and
 FIG. 7 is a bottom plan view thereof.

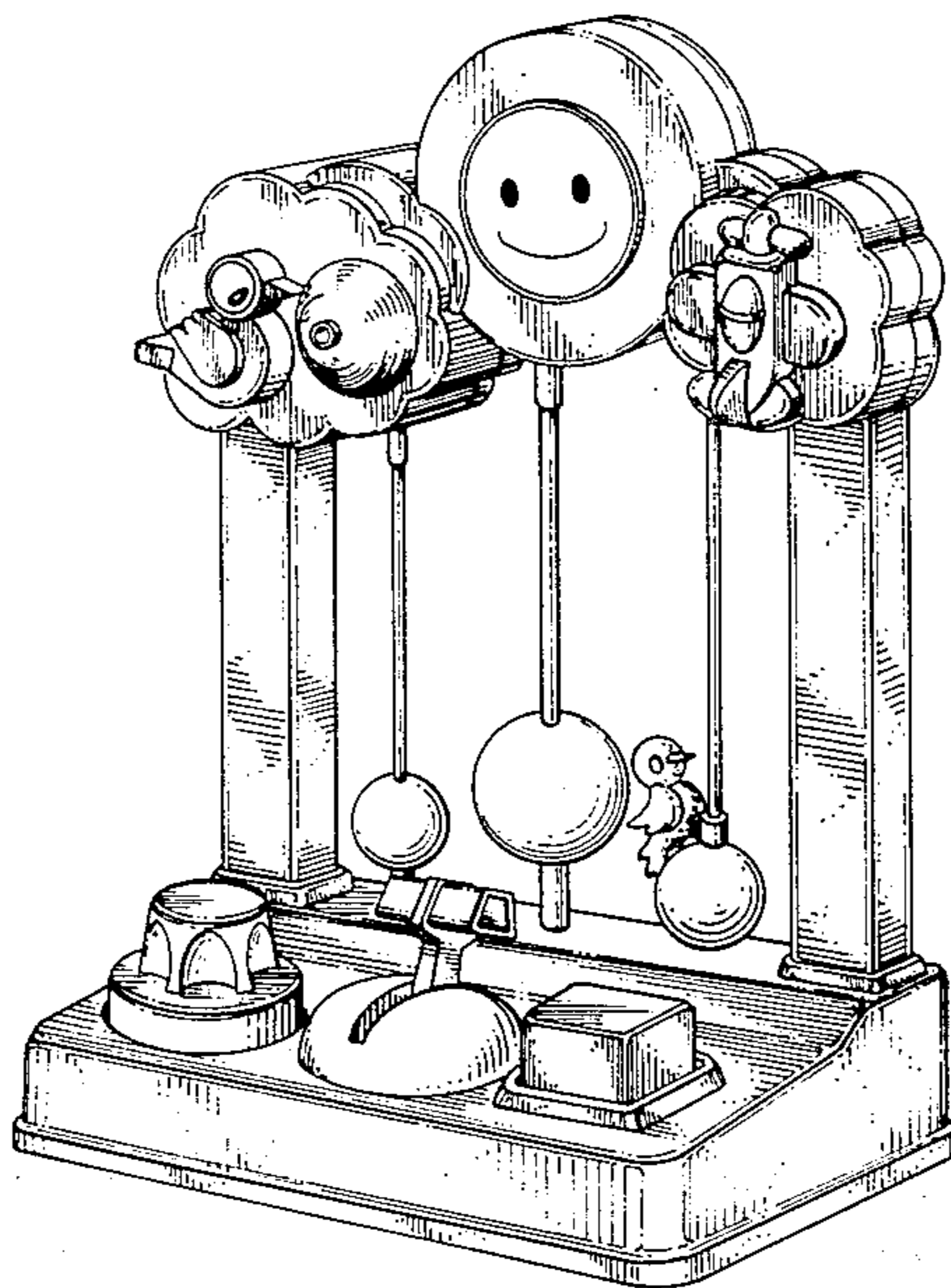

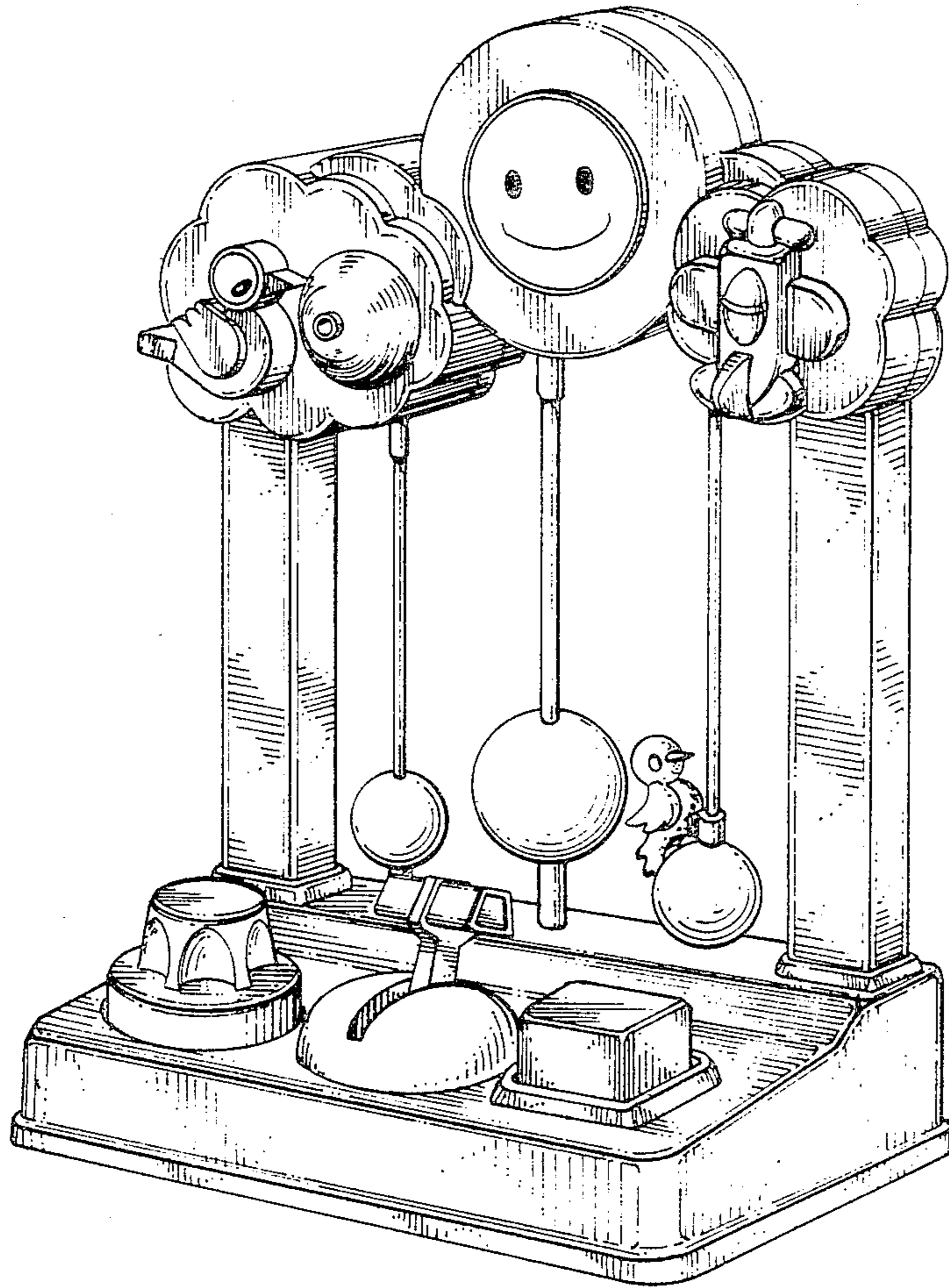

FIG. 1

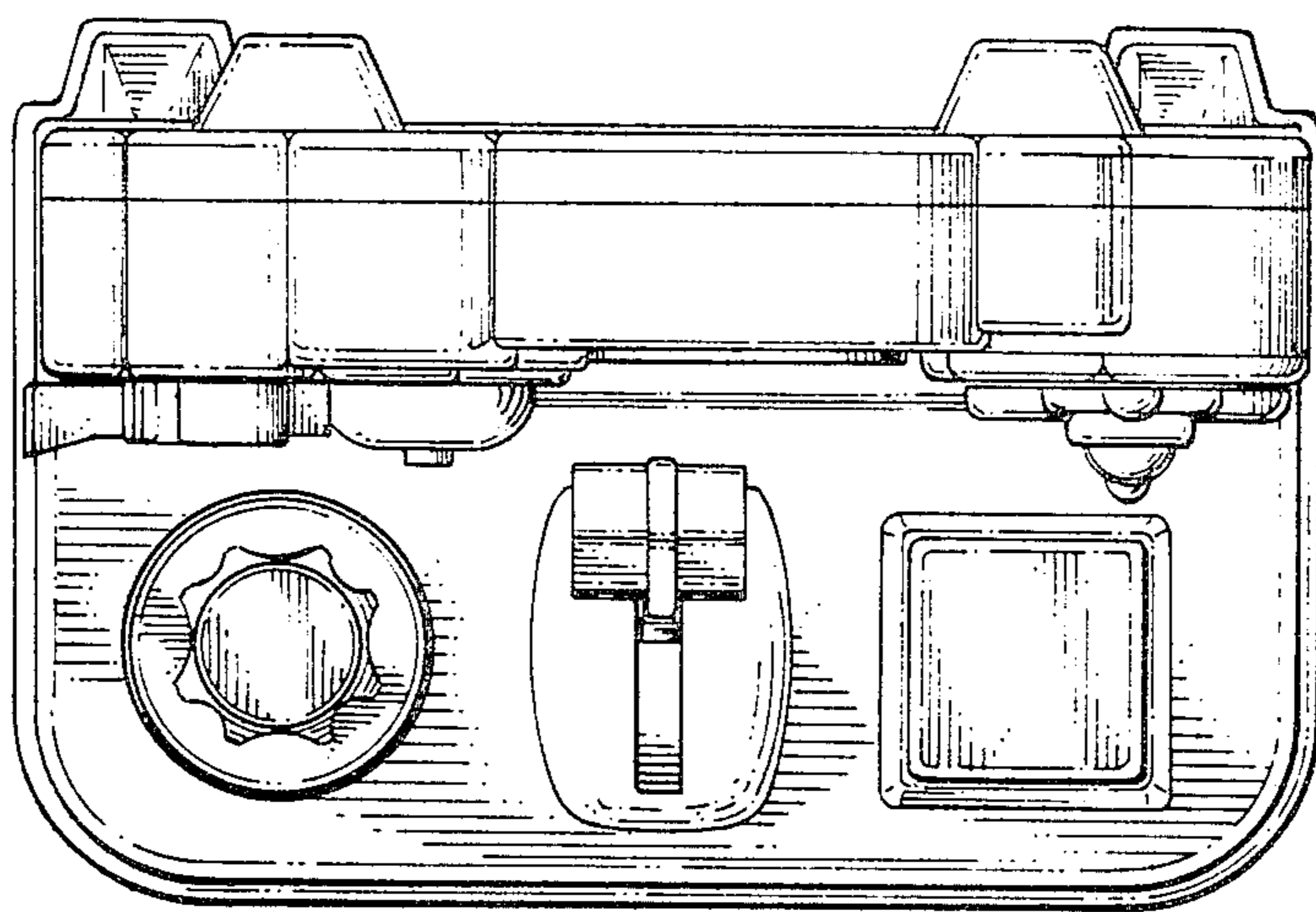

FIG. 2