

[54] CENTRIFUGATION MACHINE FOR SEPARATING, DRYING OR THE LIKE

[75] Inventor: Paul Besson, Sevres, France

[73] Assignee: Guinard Centrifugation, Saint-Cloud, France

[**] Term: 14 Years

[21] Appl. No.: 509,768

[22] Filed: Jun. 30, 1983

[52] U.S. Cl. D15/147; D15/199

[58] Field of Search D15/199, 147; D24/22; 34/58, 59; 209/148, 139.2, 199

[56] References Cited

U.S. PATENT DOCUMENTS

1,931,749	10/1933	Bigsby	34/58
3,269,028	8/1966	Strich	34/58
3,425,135	2/1969	Langsetmo et al.	34/58

3,700,467 1/1955 Dorman 209/199

Primary Examiner—B. J. Bullock
Attorney, Agent, or Firm—Gipple & Hale

[57] CLAIM

The ornamental design for centerifugation machine for separating, drying or the like, substantially as shown and described.

DESCRIPTION

FIG. 1 is a side elevational view of a centrifugation machine for separating, drying or the like showing my new design;

FIG. 2 is a side elevational view of the side opposite that shown in FIG. 1;

FIG. 3 is an end elevational view taken from the right of FIG. 1;

FIG. 4 is an end elevational view taken from the left of FIG. 1;

FIG. 5 is a top plan view thereof, the bottom being unornamented.

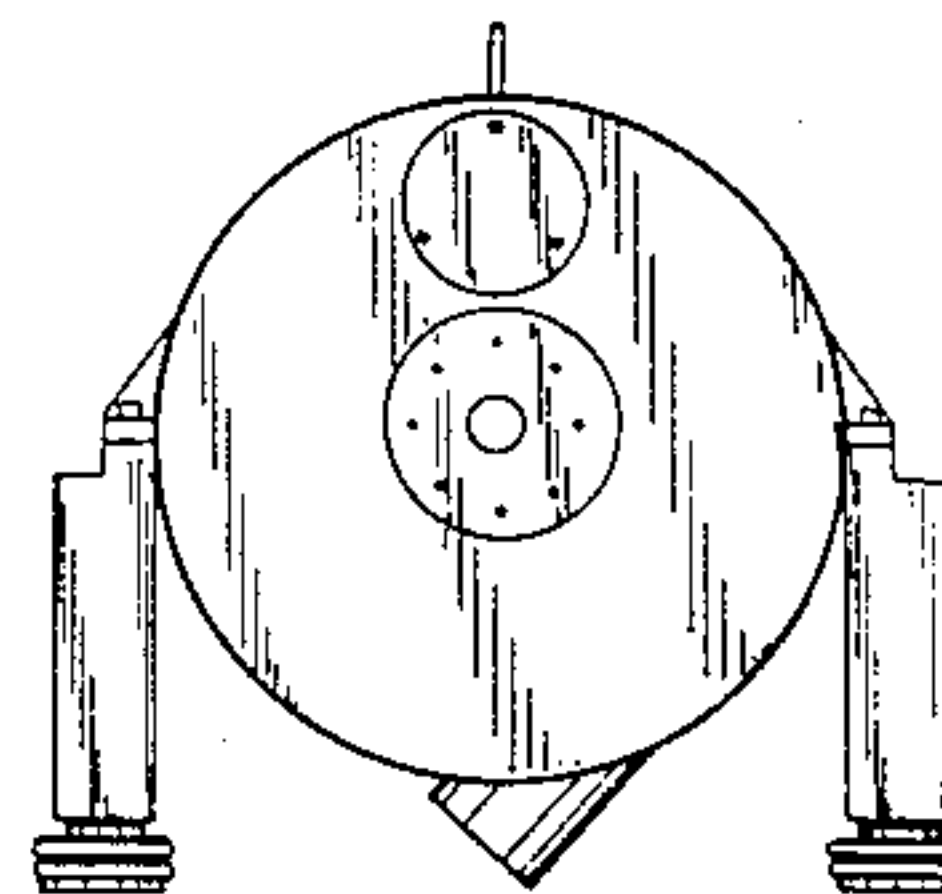
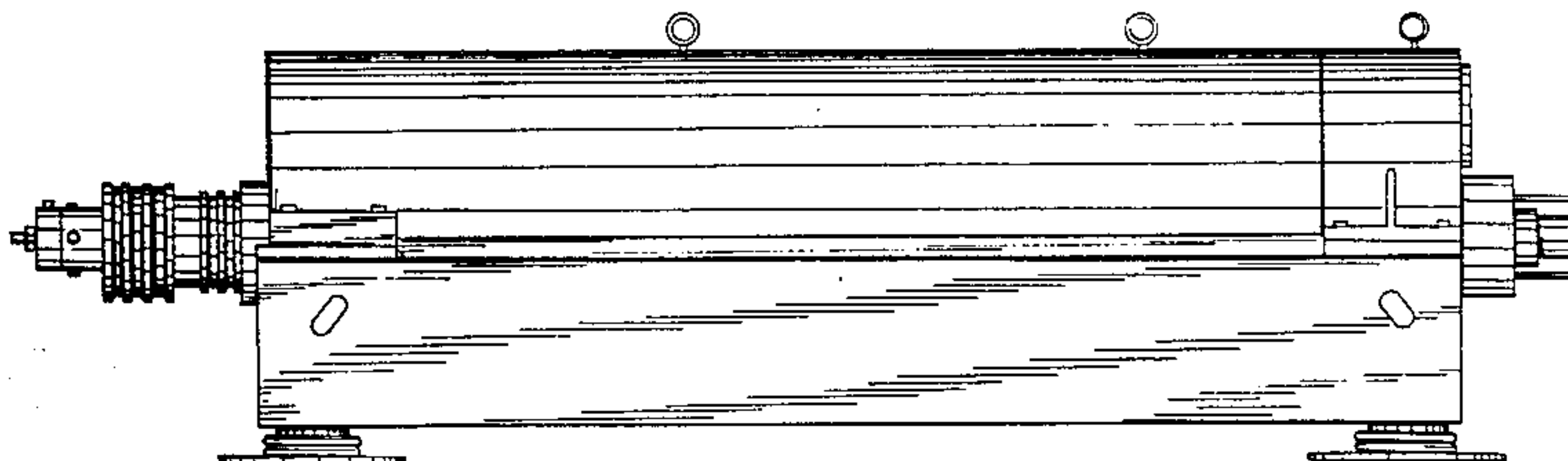

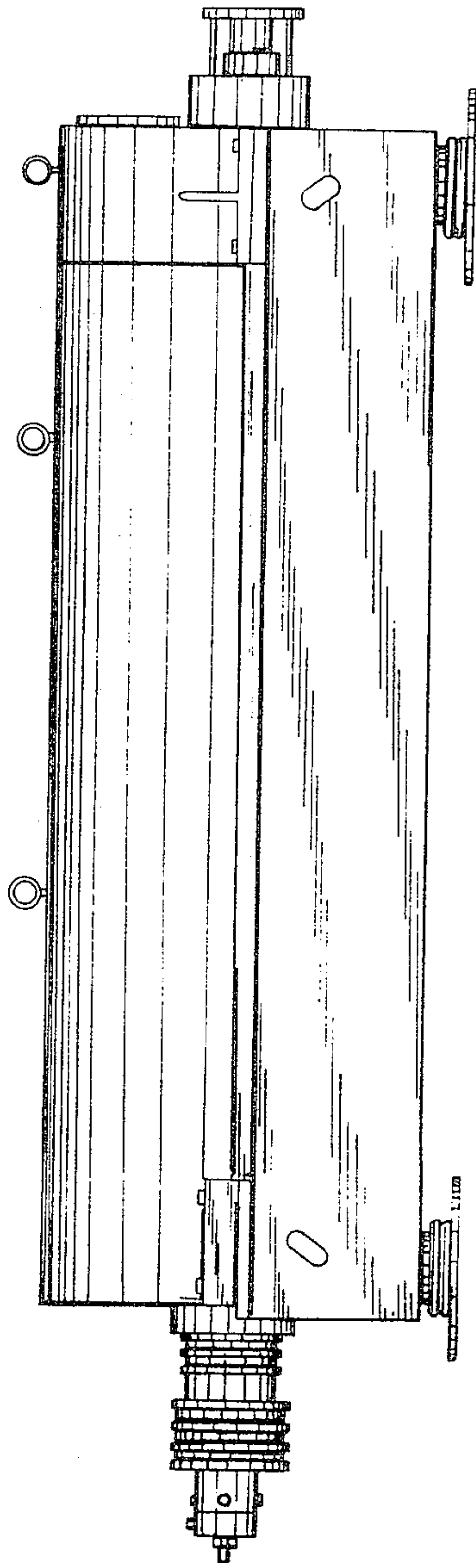

Fig. 1

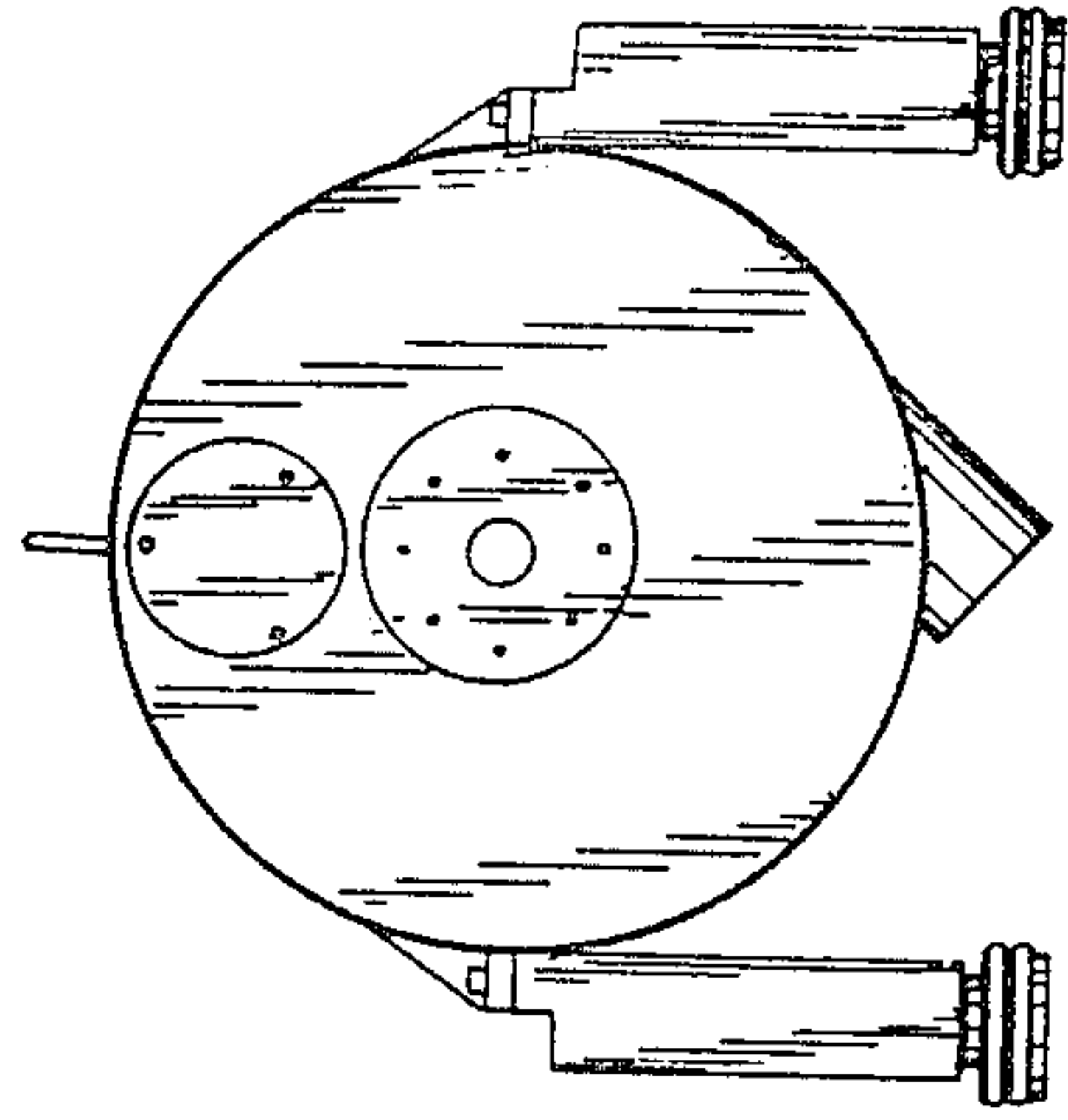

Fig. 2

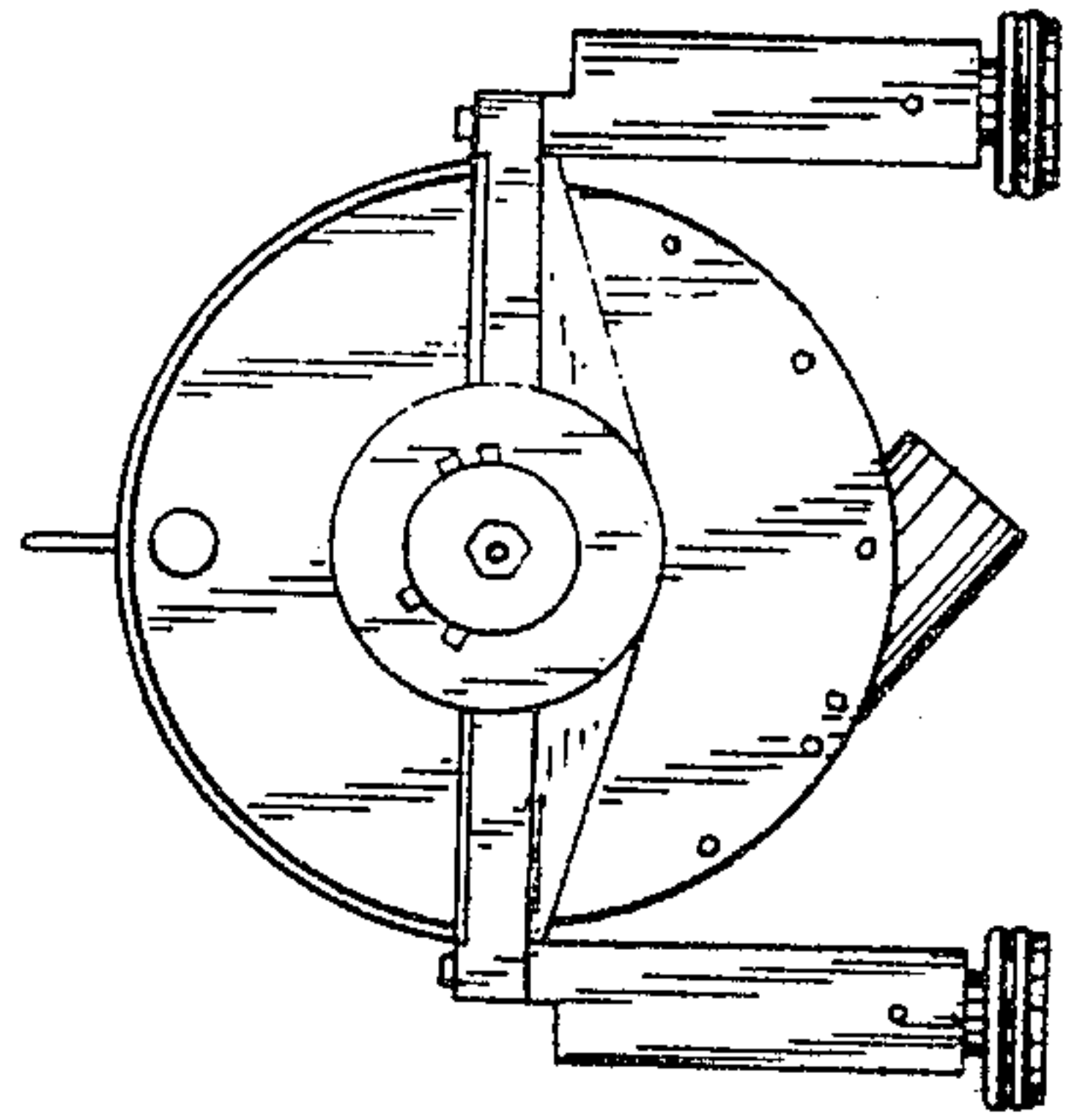

Fig. 3

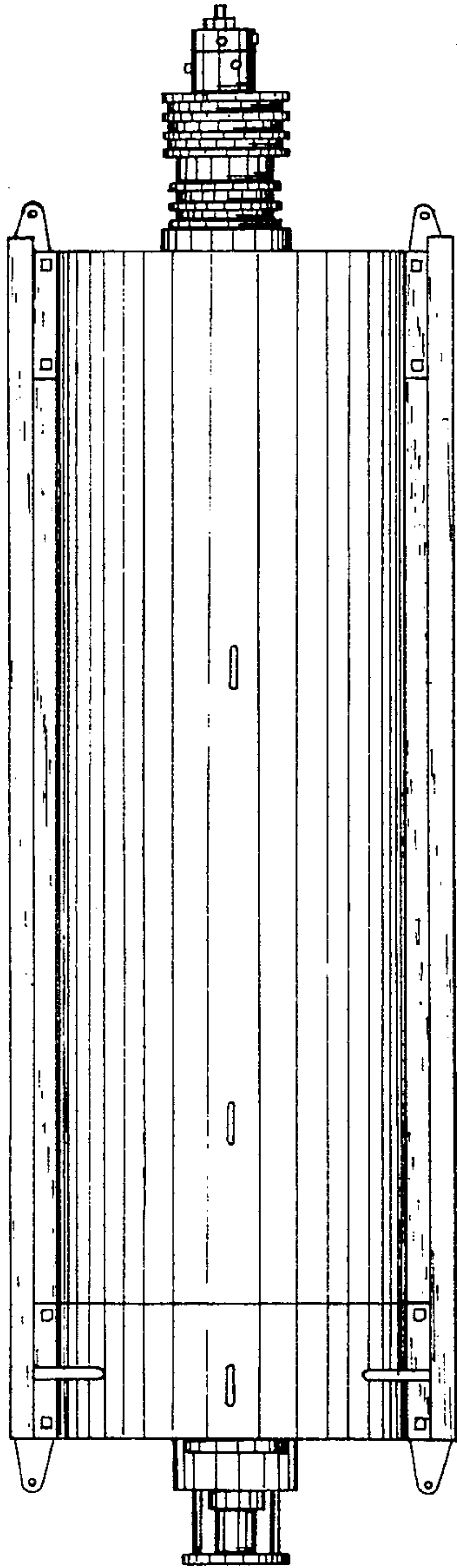

Fig. 3

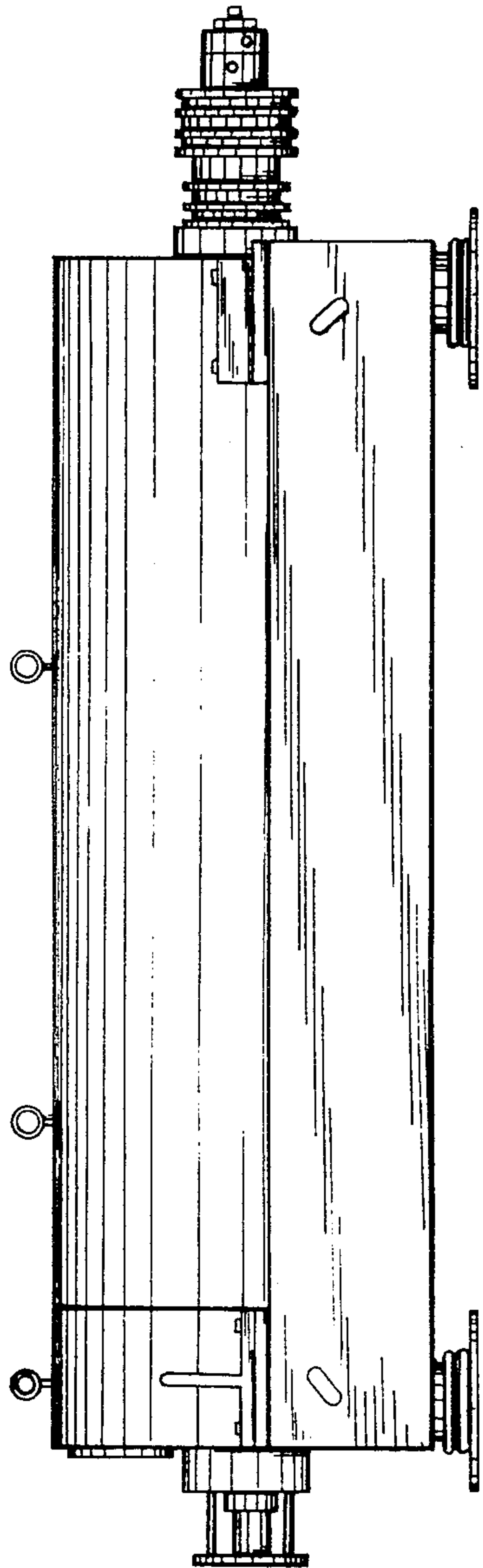

Fig. 2