

[54] **CASSEROLE**

[75] **Inventor: Franklin E. Schrage, Monroe, Conn.**

[73] **Assignee: Union Carbide Corporation,
Danbury, Conn.**

[**] **Term: 14 Years**

[21] **Appl. No.: 496,265**

[22] **Filed: May 19, 1983**

[52] **U.S. Cl. D7/360**

[58] **Field of Search D7/354, 360, 21, 28,
D7/23, 36; D9/425, 428, 429; 99/426, 425, 428;
219/10.55 E; 220/4 B, 4 E, 366**

[56] **References Cited**

U.S. PATENT DOCUMENTS

D. 120,991 6/1940 Koch D7/354 X
D. 173,093 9/1954 Schreckengost D7/360
4,014,450 3/1977 Girotti et al. 220/4 B

FOREIGN PATENT DOCUMENTS

1165937 10/1958 France 220/4 B

OTHER PUBLICATIONS

Better Homes and Gardens, Nov. 83, p. 39, Rubbermaid Microwave Cookware.

Primary Examiner—Bernard Ansher
Assistant Examiner—Linda Titolo
Attorney, Agent, or Firm—Dale Lynn Carlson

[57] **CLAIM**

The ornamental design for a casserole, as shown and described.

DESCRIPTION

FIG. 1 is a top plan view of a casserole showing my new design;

FIG. 2 is a bottom plan view thereof;

FIG. 3 is a side elevational view thereof;

FIG. 4 is a cross sectional view thereof taken on line 4—4 of FIG. 1;

FIG. 5 is a front elevational view thereof; and

FIG. 6 is a cross sectional view thereof taken on line 6—6 of FIG. 1.

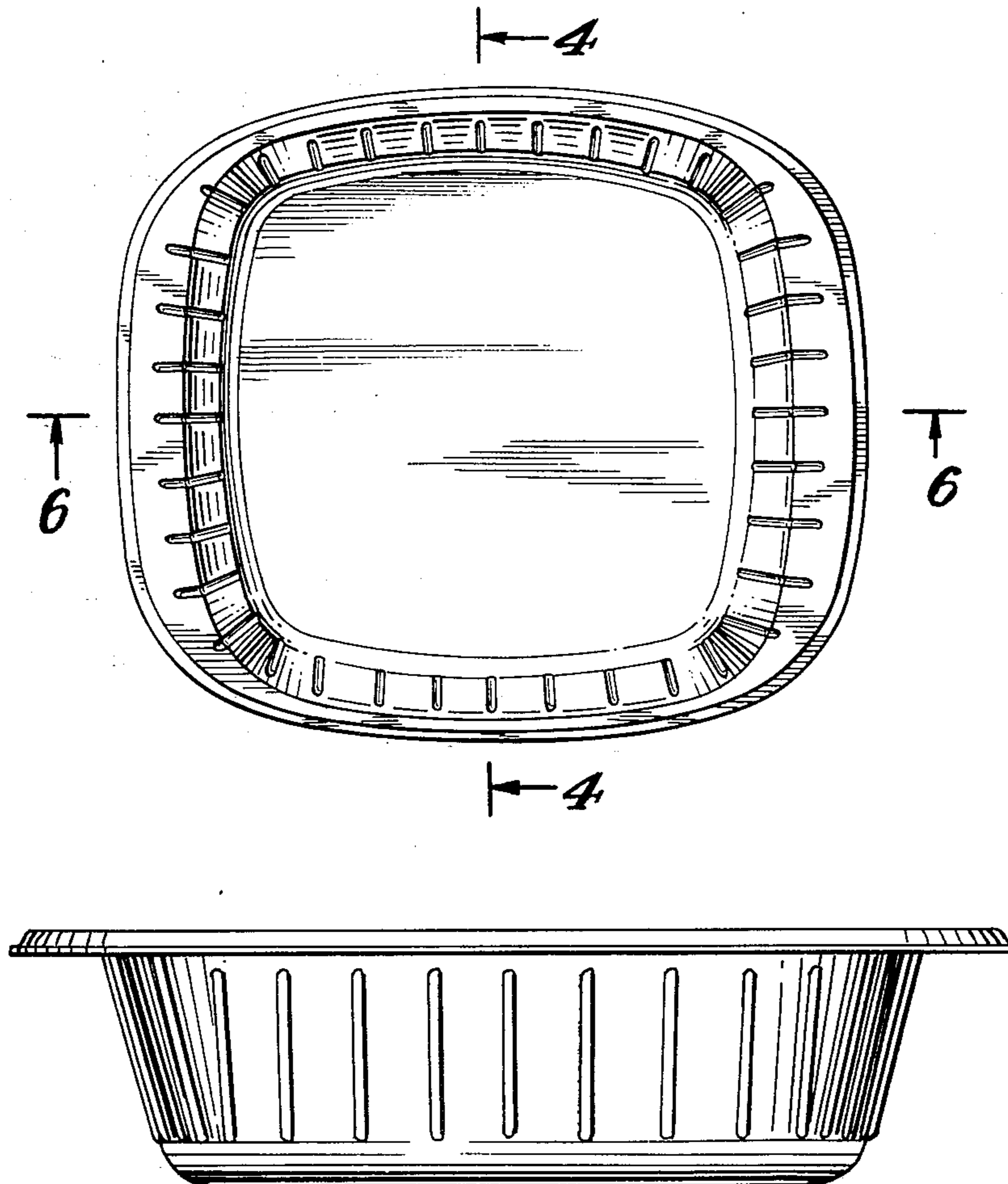

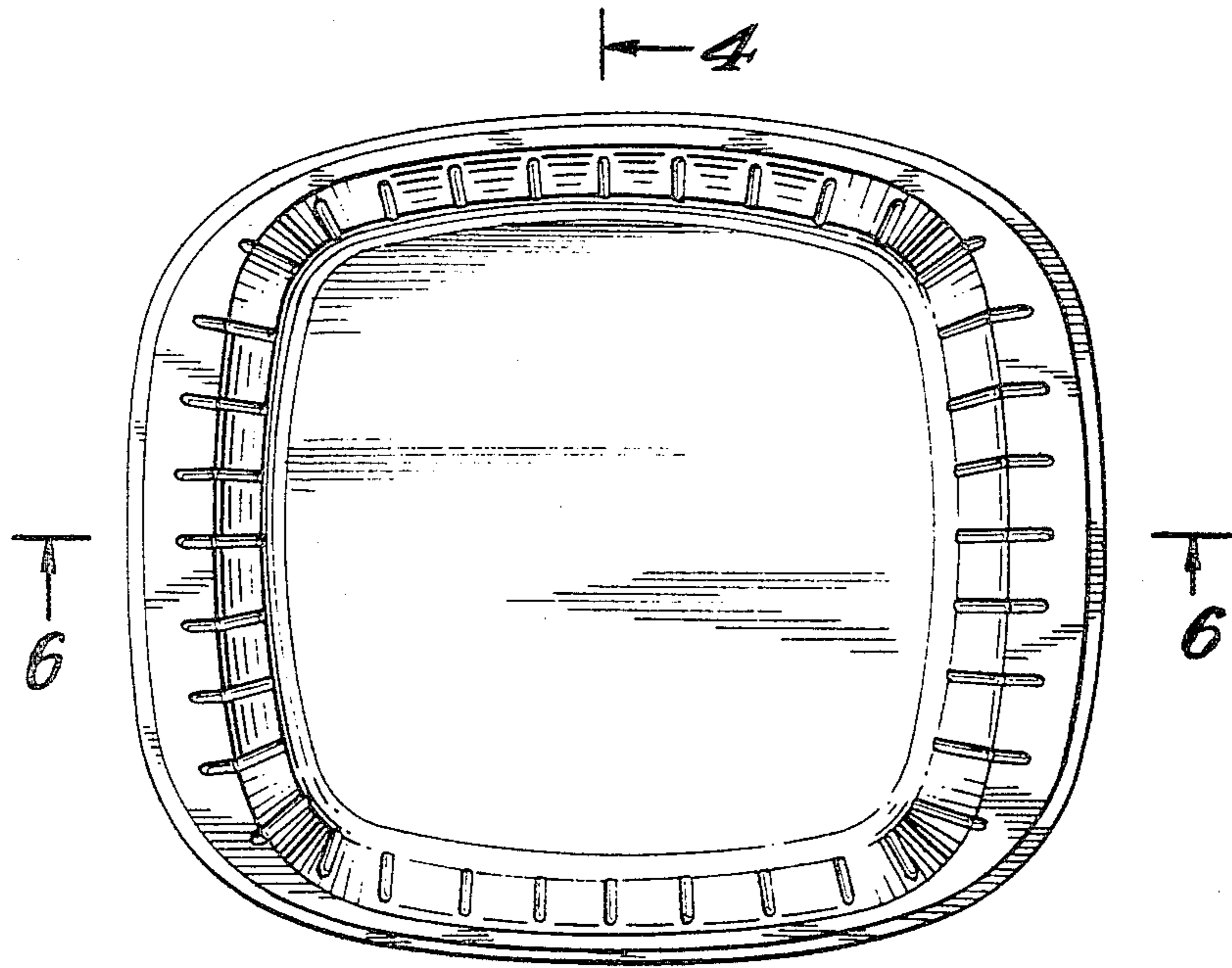

FIG. 1

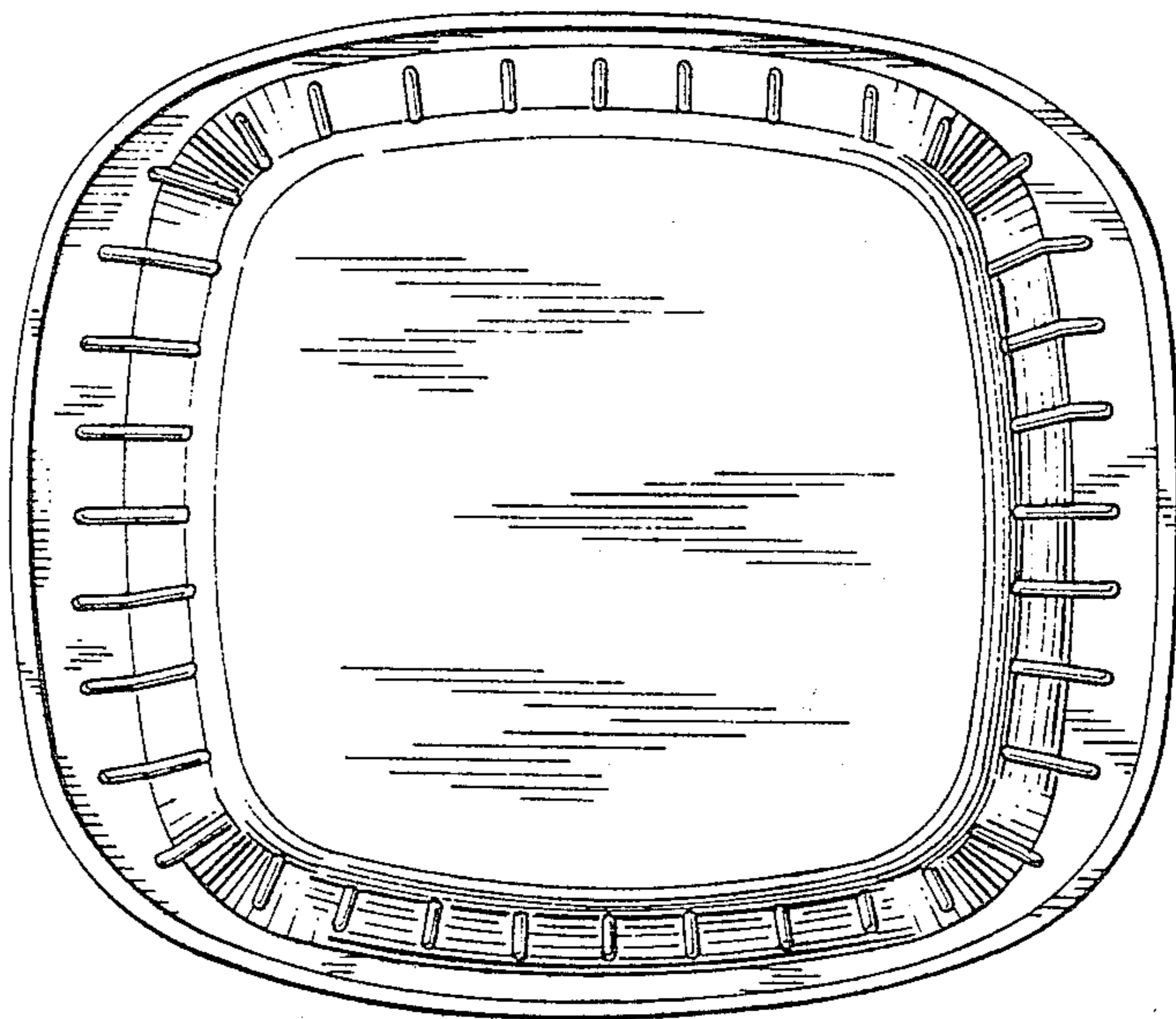

FIG. 2

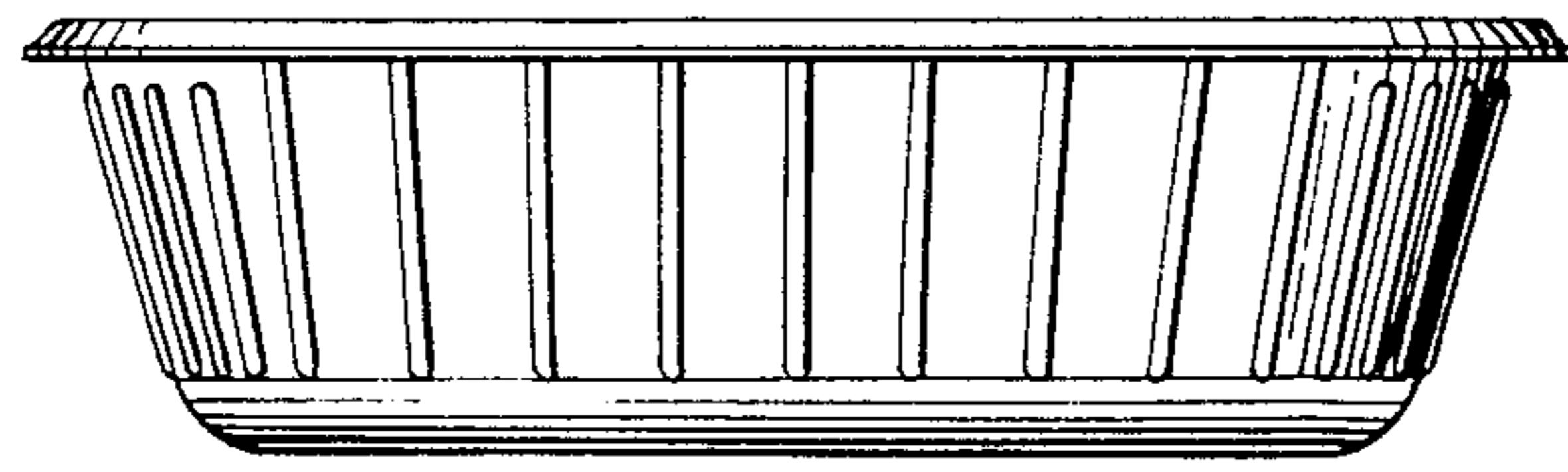

FIG. 3

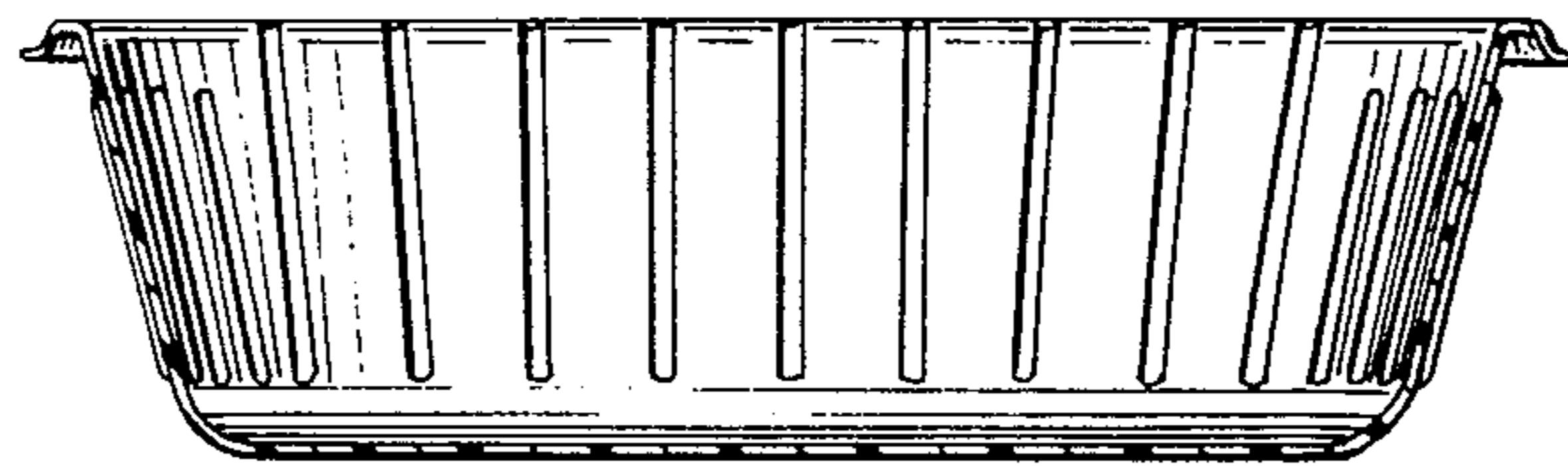

FIG. 4

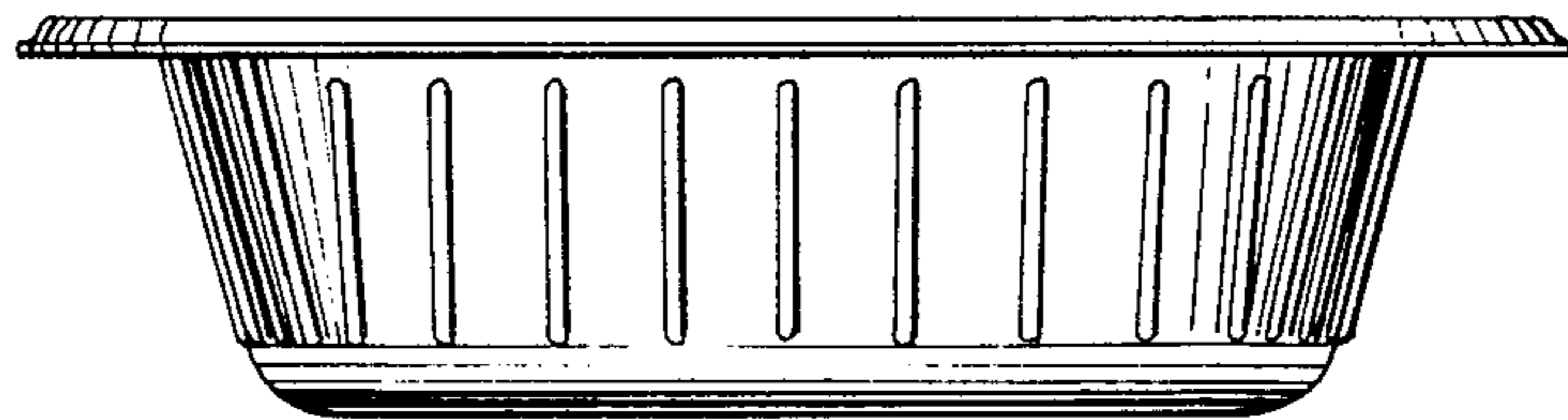

FIG. 5

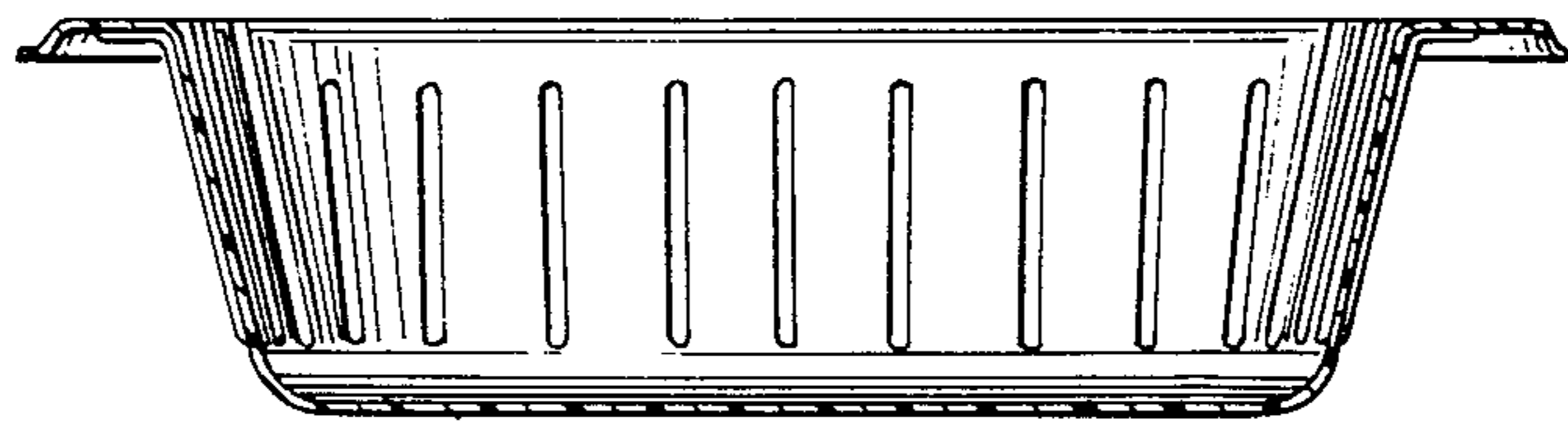

FIG. 6