

[54] **MOTORCYCLE VALVE COVER**

[75] **Inventor:** Alwin J. Stahel, St. Paul, Minn.

[73] **Assignee:** Drag Specialties, Inc., Minnetonka, Minn.

[\*\*] **Term:** 14 Years

[21] **Appl. No.:** 505,864

[22] **Filed:** Jun. 20, 1983

[52] **U.S. Cl.** ..... D12/126

[58] **Field of Search** ..... D12/114, 126;  
280/289 G, 289 R; 180/219

[56] **References Cited**

**U.S. PATENT DOCUMENTS**

4,454,714 6/1984 Ikenoya et al. .... 180/219

**OTHER PUBLICATIONS**

Touring Bike, 5/82, p. 6, Drag Specialties Valve Cover, center left side of page.

Touring Bike, 5/82, p. 60, Valve Cover on Honda Motorcycle, bottom of page.

*Primary Examiner*—James M. Gandy  
*Attorney, Agent, or Firm*—Kinney & Lange

[57] **CLAIM**

The ornamental design for a motorcycle valve cover, as shown and described.

**DESCRIPTION**

FIG. 1 is a front elevational view of a motorcycle valve cover embodying my new design in a position of use, it being understood that the broken lines are for illustration purposes only.

FIG. 2 is an enlarged front elevational view thereof;

FIG. 3 is an enlarged rear elevational view thereof;

FIG. 4 is an enlarged top plan view thereof;

FIG. 5 is an enlarged bottom plan view thereof; and

FIG. 6 is an enlarged left side elevational view thereof;

and

FIG. 7 is an enlarged right side elevational view thereof.

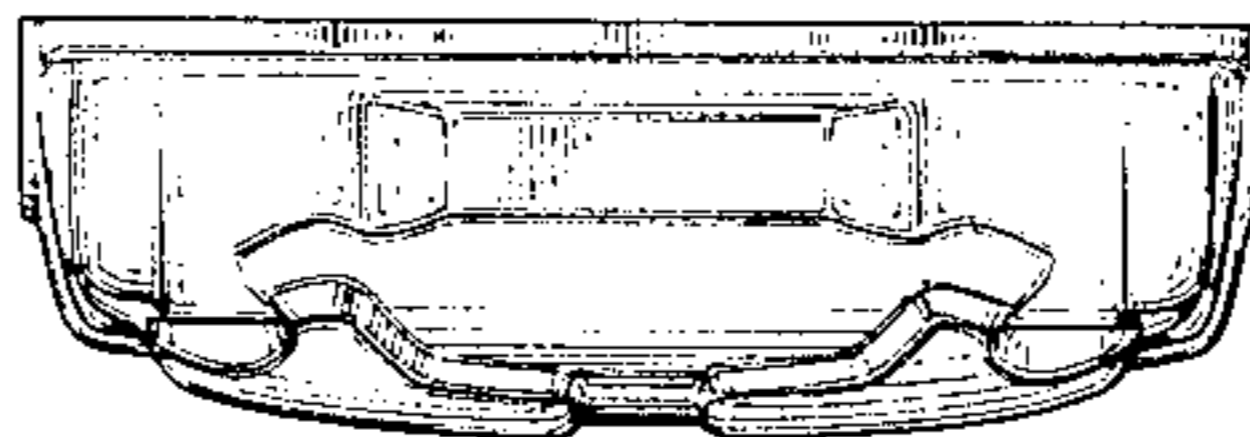
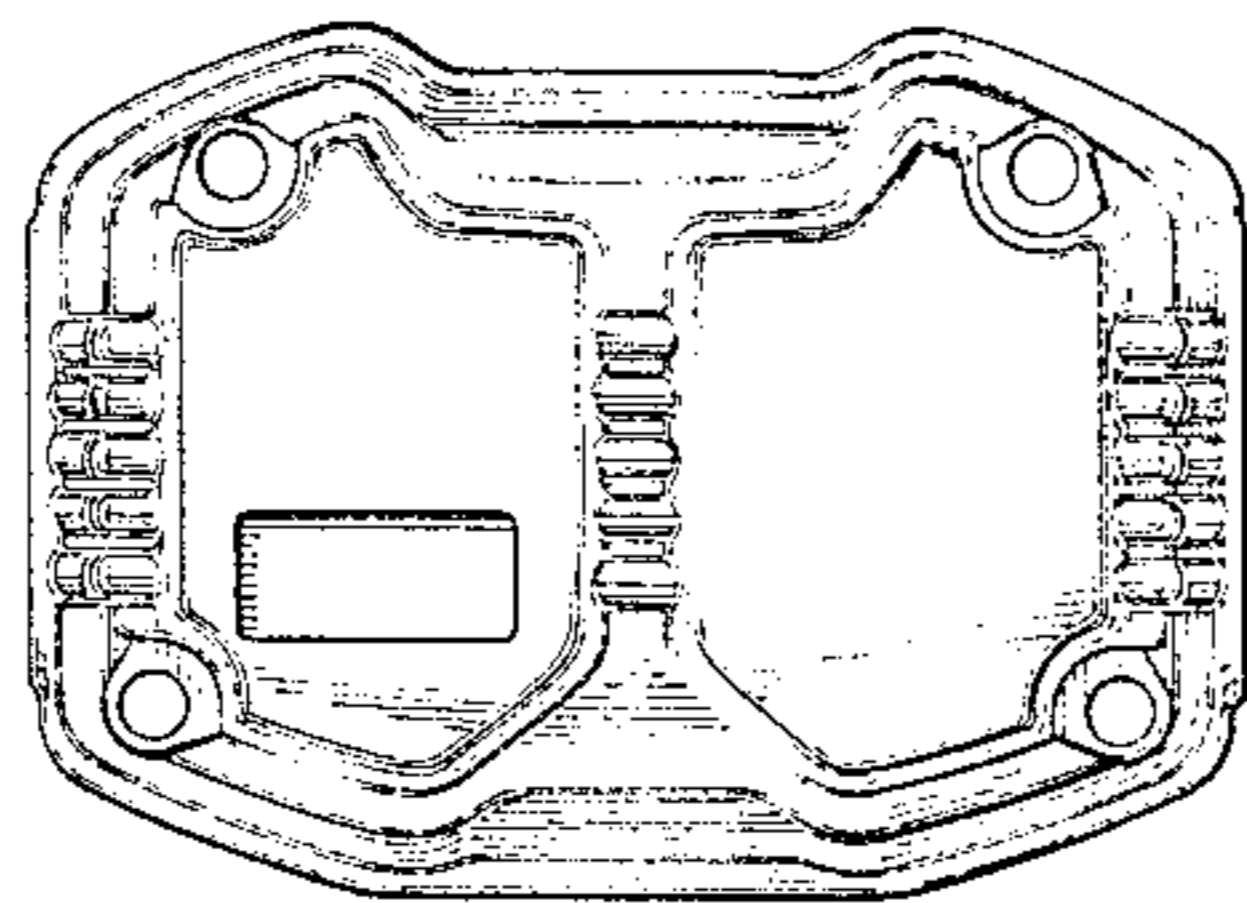

**Fig. 1**

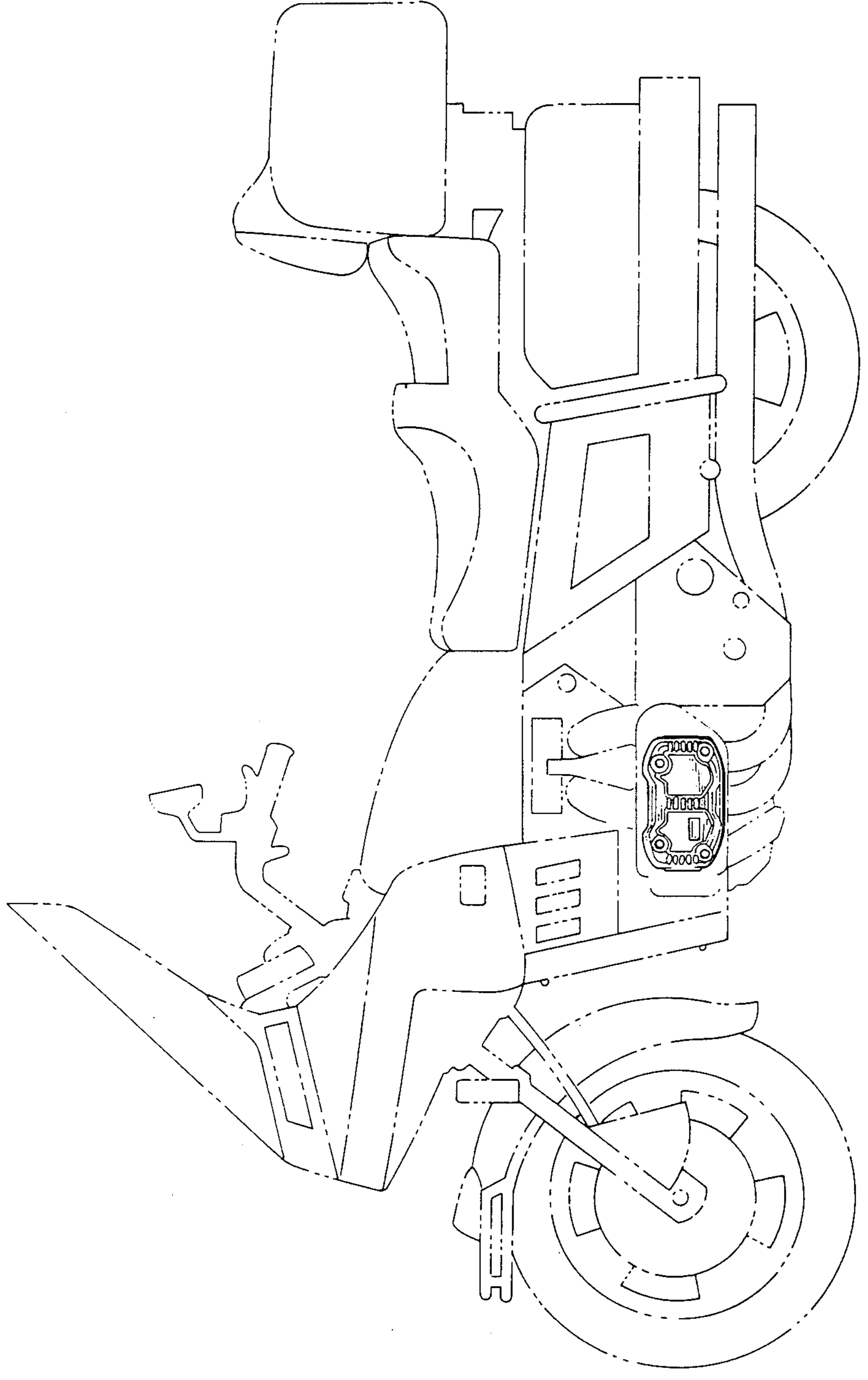

**Fig. 2**

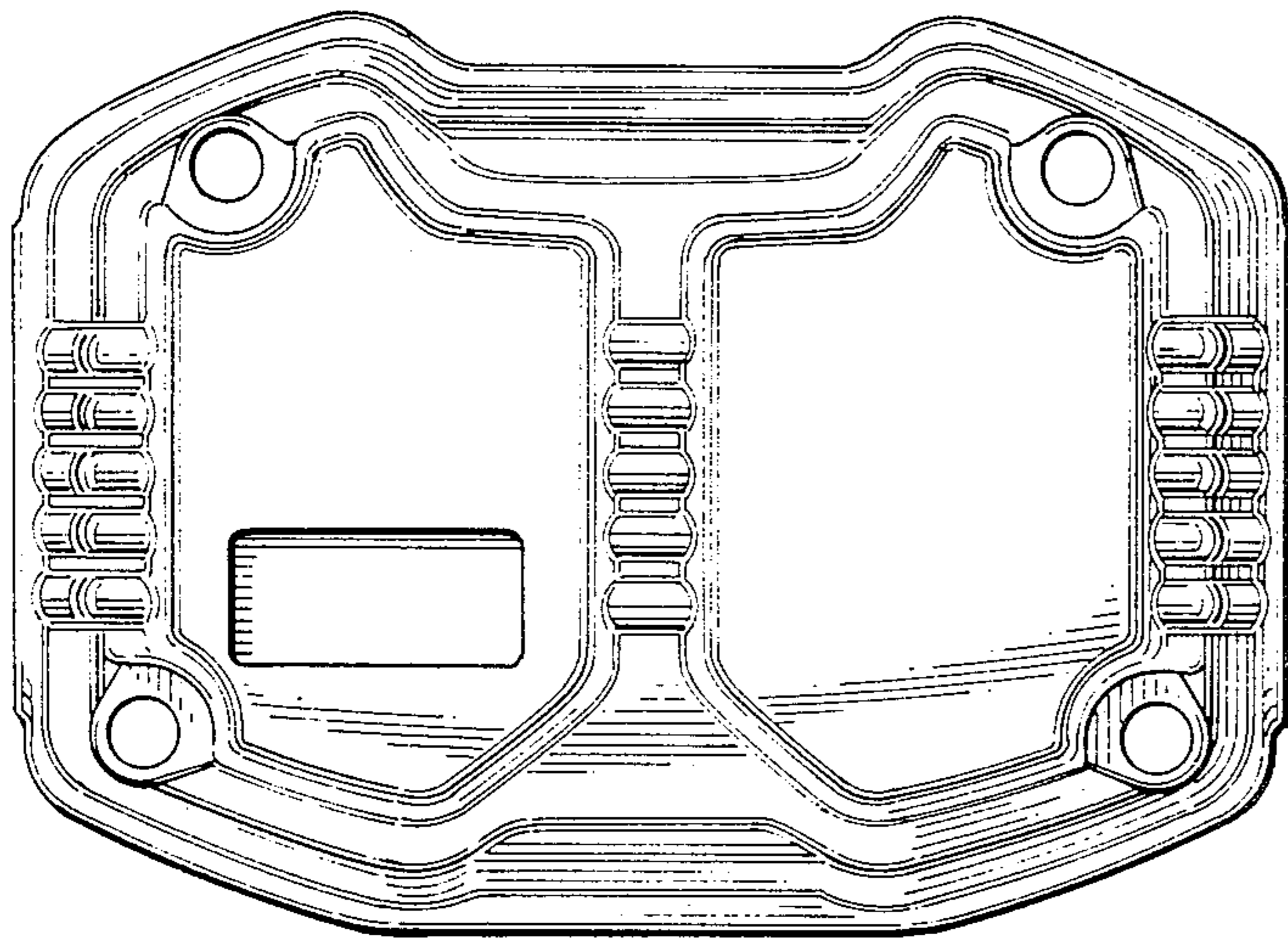

**Fig. 3**

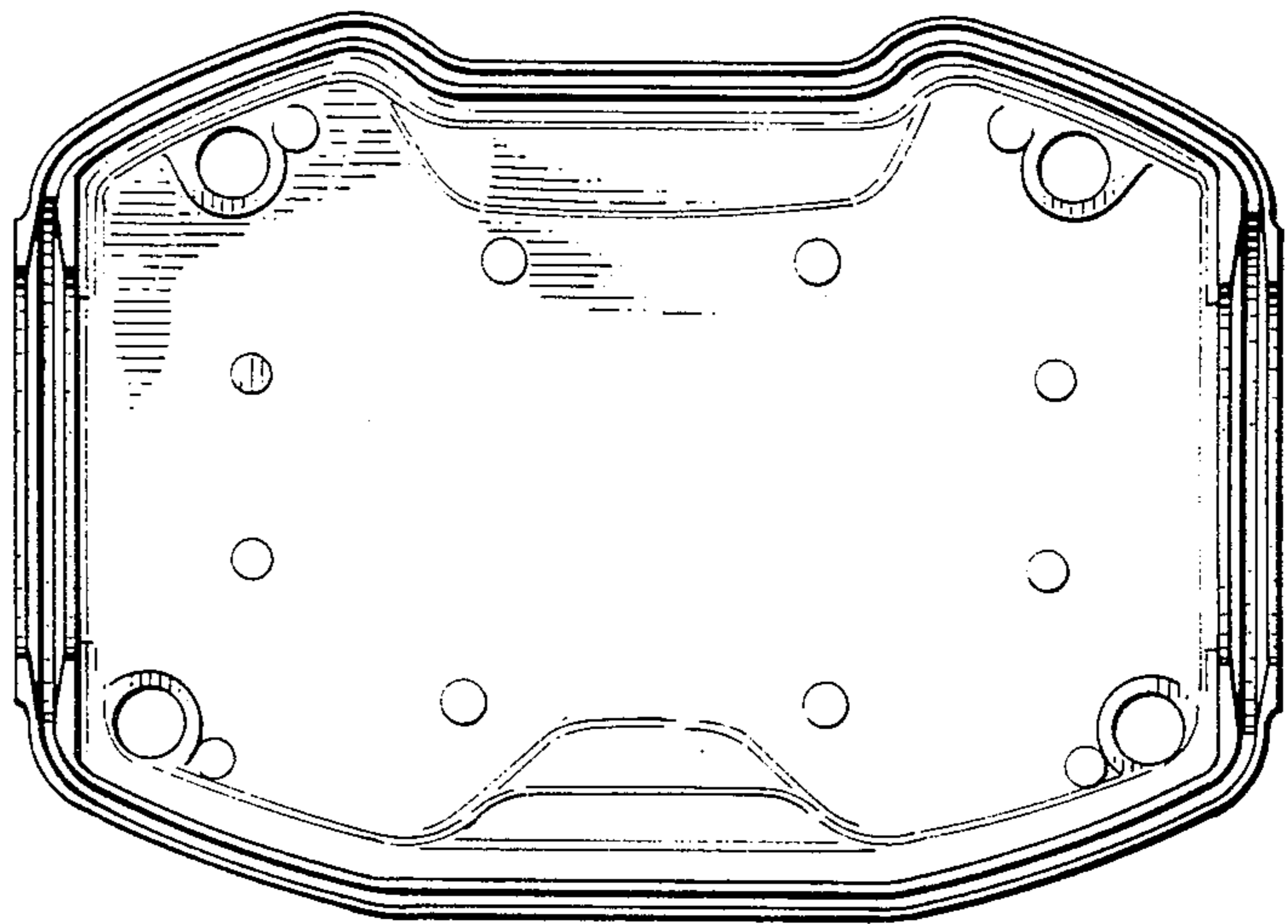

**Fig. 4**

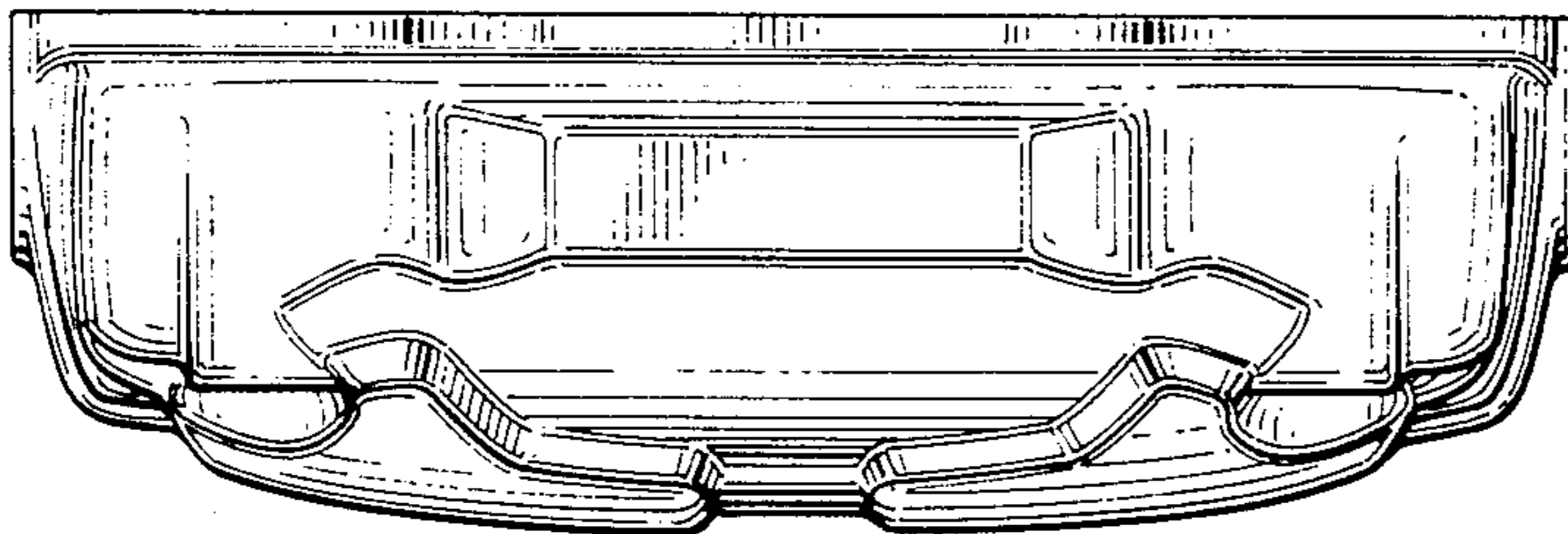

**Fig. 5**

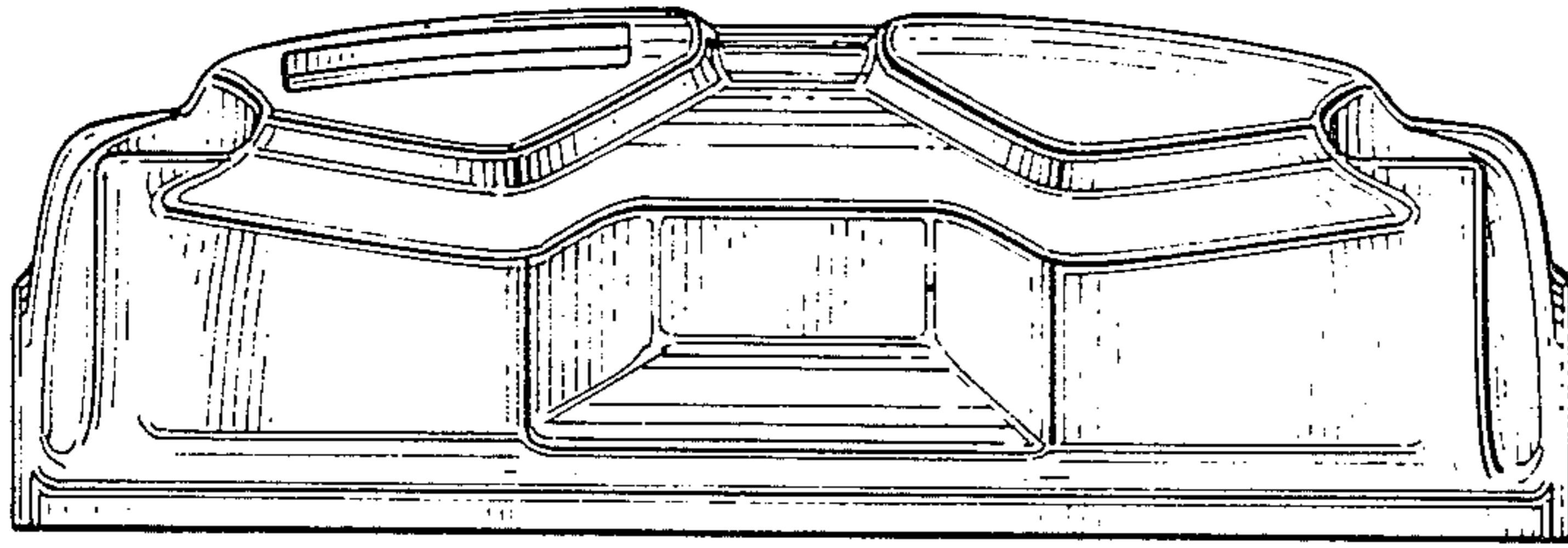

**Fig. 6**

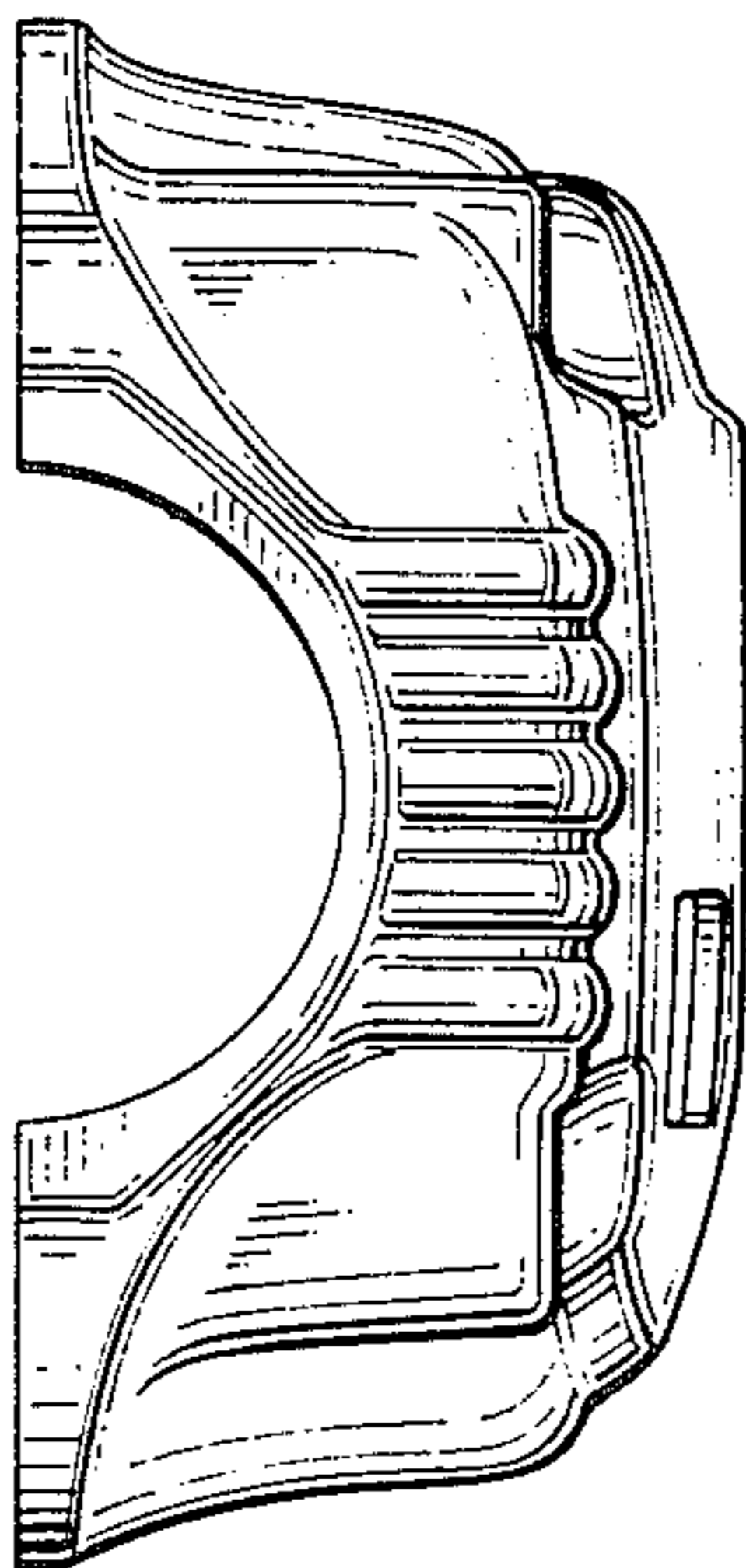

**Fig. 7**

