

[54] GARMENT BAG

[76] Inventor: Richard B. Gibbs, 11548 Thurston Cir., Los Angeles, Calif. 90049

[\*\*] Term: 14 Years

[21] Appl. No.: 511,951

[22] Filed: Jul. 8, 1983

[52] U.S. Cl. .... D3/71; D3/77

[58] Field of Search ..... D3/30.1, 42, 48, 71, D3/74, 76, 77; 190/100, 102, 103, 115; 206/286, 287, 287.1

[56] References Cited

U.S. PATENT DOCUMENTS

D. 265,607	8/1982	Cooper	.....	D3/71
D. 265,779	8/1982	Stark	.....	D3/71
D. 267,677	1/1983	Pelavin	.....	D3/71
D. 273,911	5/1984	Pelavin	.....	D3/71
4,098,376	7/1978	Pelavin	.....	D3/71

Primary Examiner—George P. Word  
Attorney, Agent, or Firm—John E. Kelly

[57] CLAIM

The ornamental design for a garment bag, substantially as shown and described.

DESCRIPTION

FIG. 1 is a top plan view of a garment bag showing my new design in the unfolded position;  
 FIG. 2 is a left side elevational view thereof;  
 FIG. 3 is a front elevational view thereof;  
 FIG. 4 is a right side elevational view thereof;  
 FIG. 5 is a bottom plan view thereof;  
 FIG. 6 is a rear elevational view thereof;  
 FIG. 7 is a perspective view of the garment bag of FIGS. 1-6 in folded position;  
 FIG. 8 is a top plan view thereof;  
 FIG. 9 is a left side elevational view thereof;  
 FIG. 10 is a bottom plan view thereof; and,  
 FIG. 11 is a rear elevational view thereof.

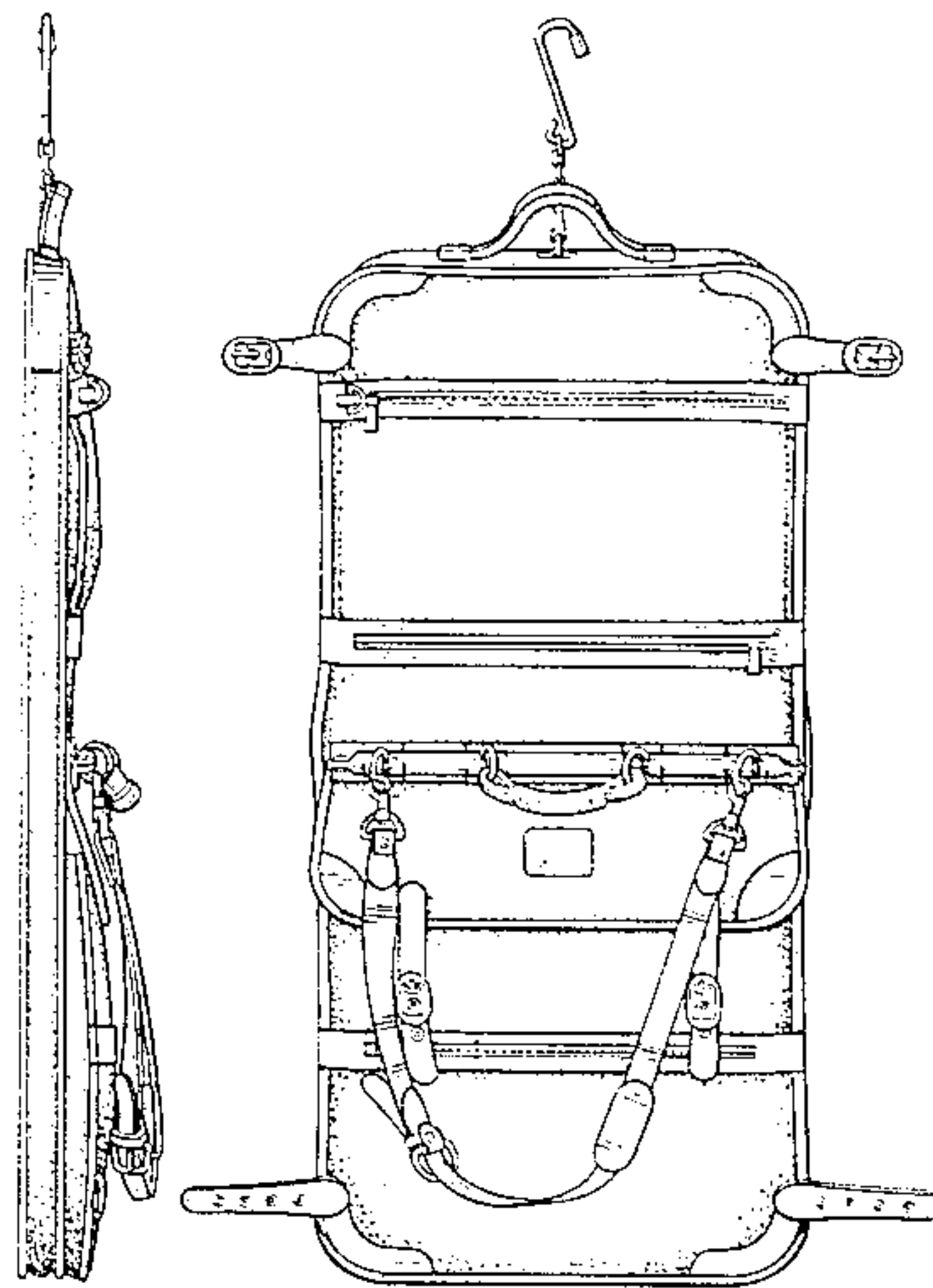

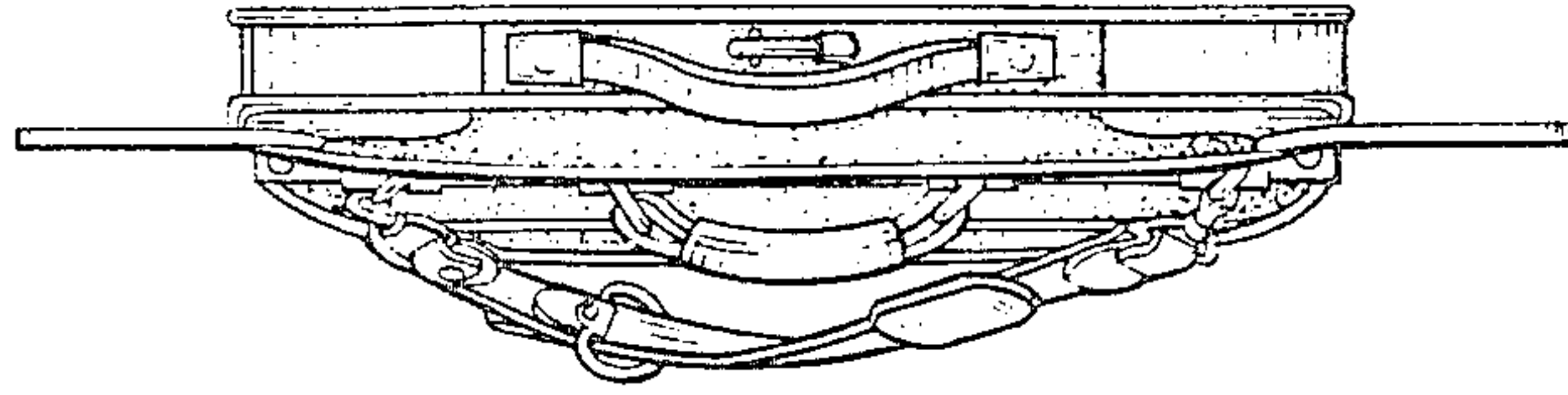

FIG. 1

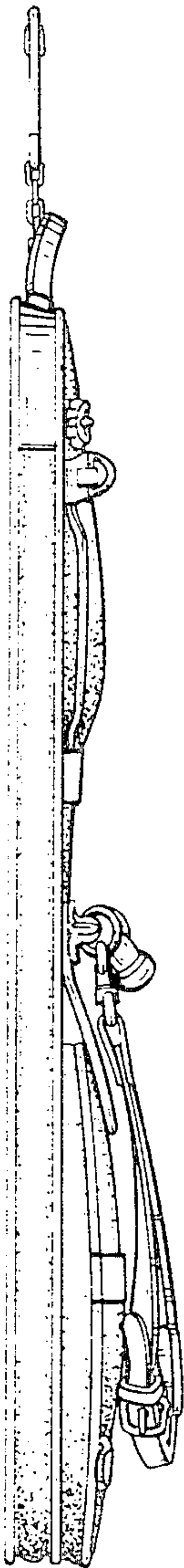

FIG. 2

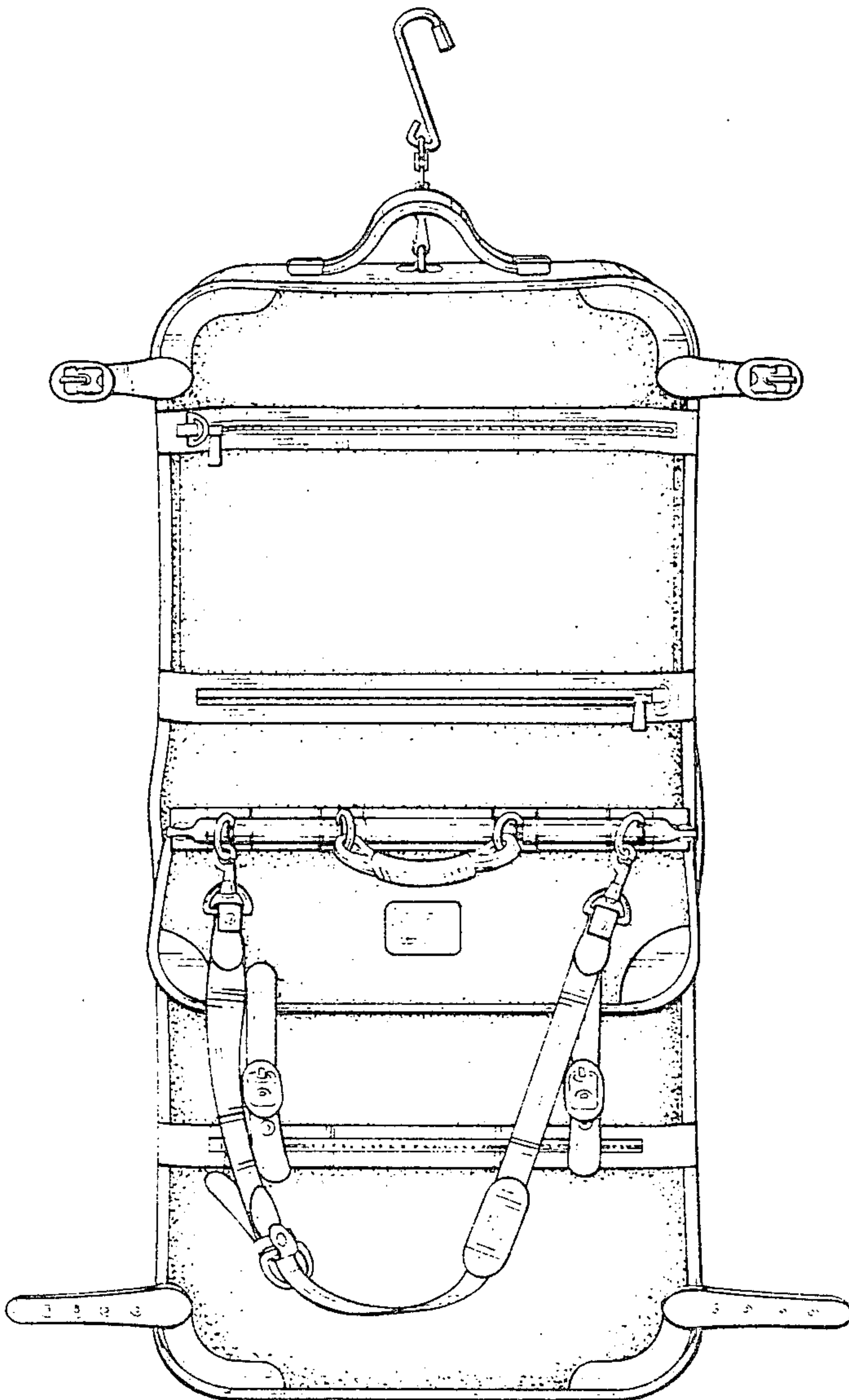

FIG. 3

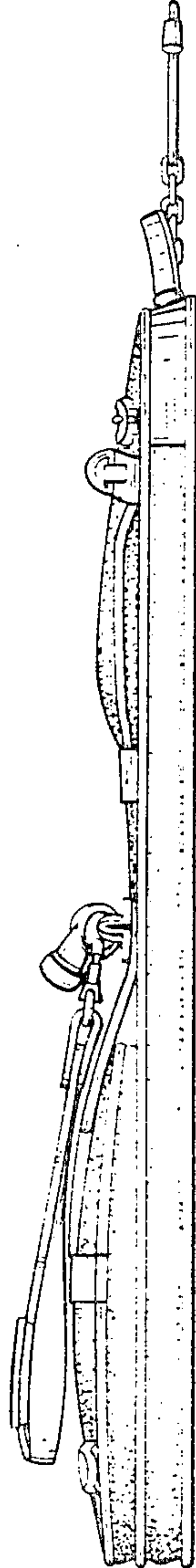

FIG. 4

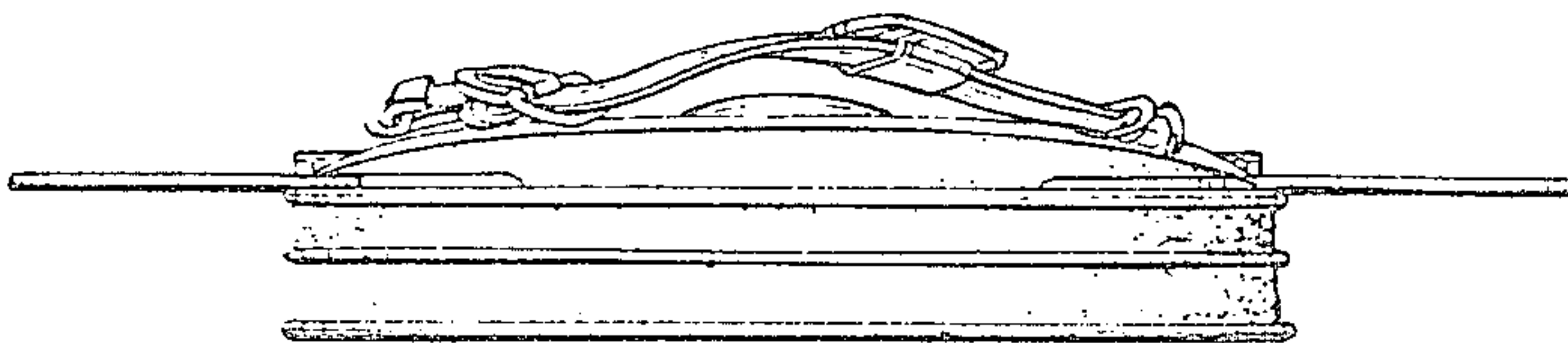

FIG. 5

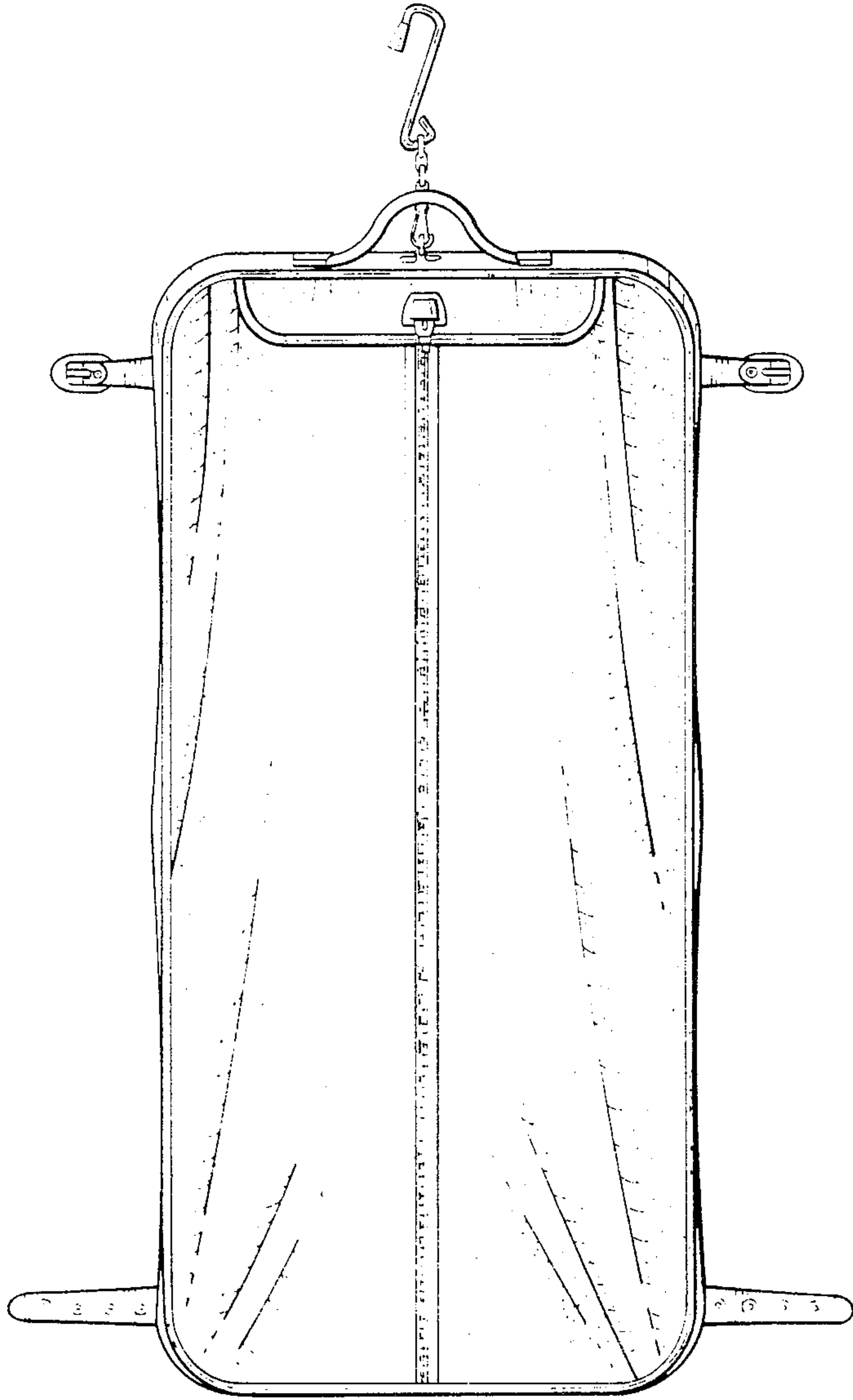

FIG. 6



FIG. 7

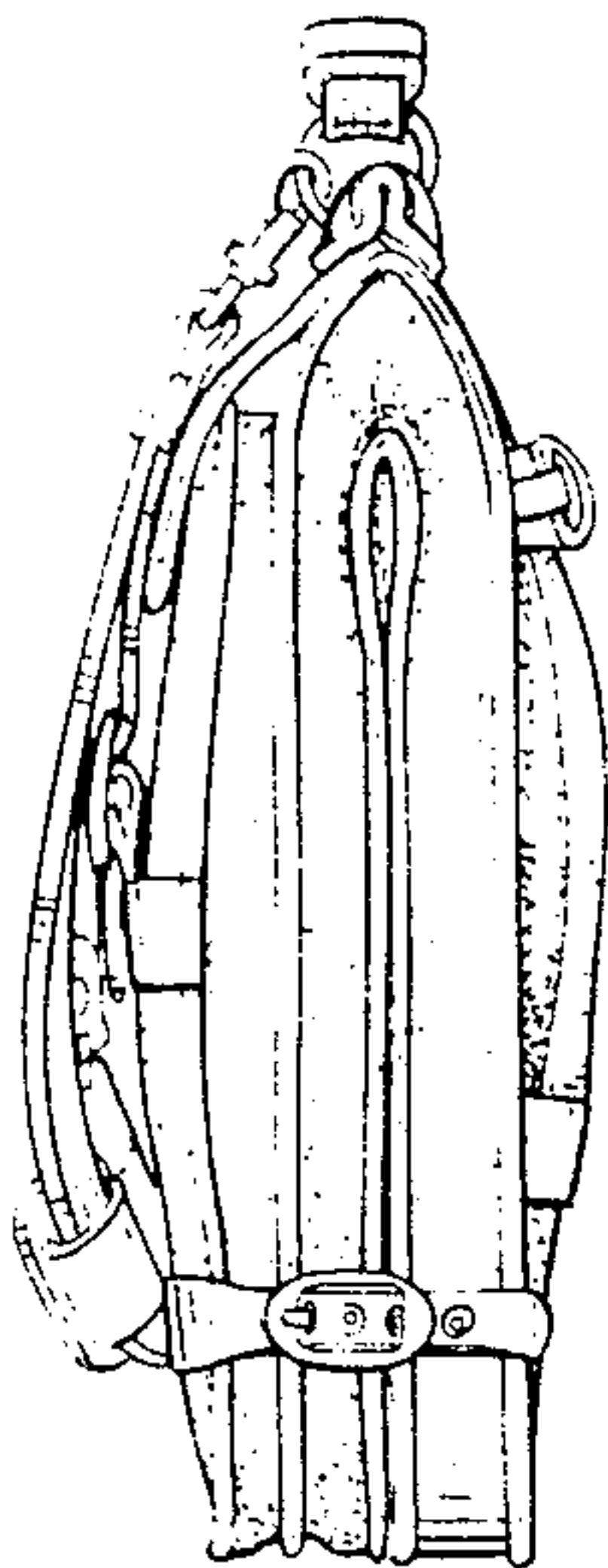

FIG. 9

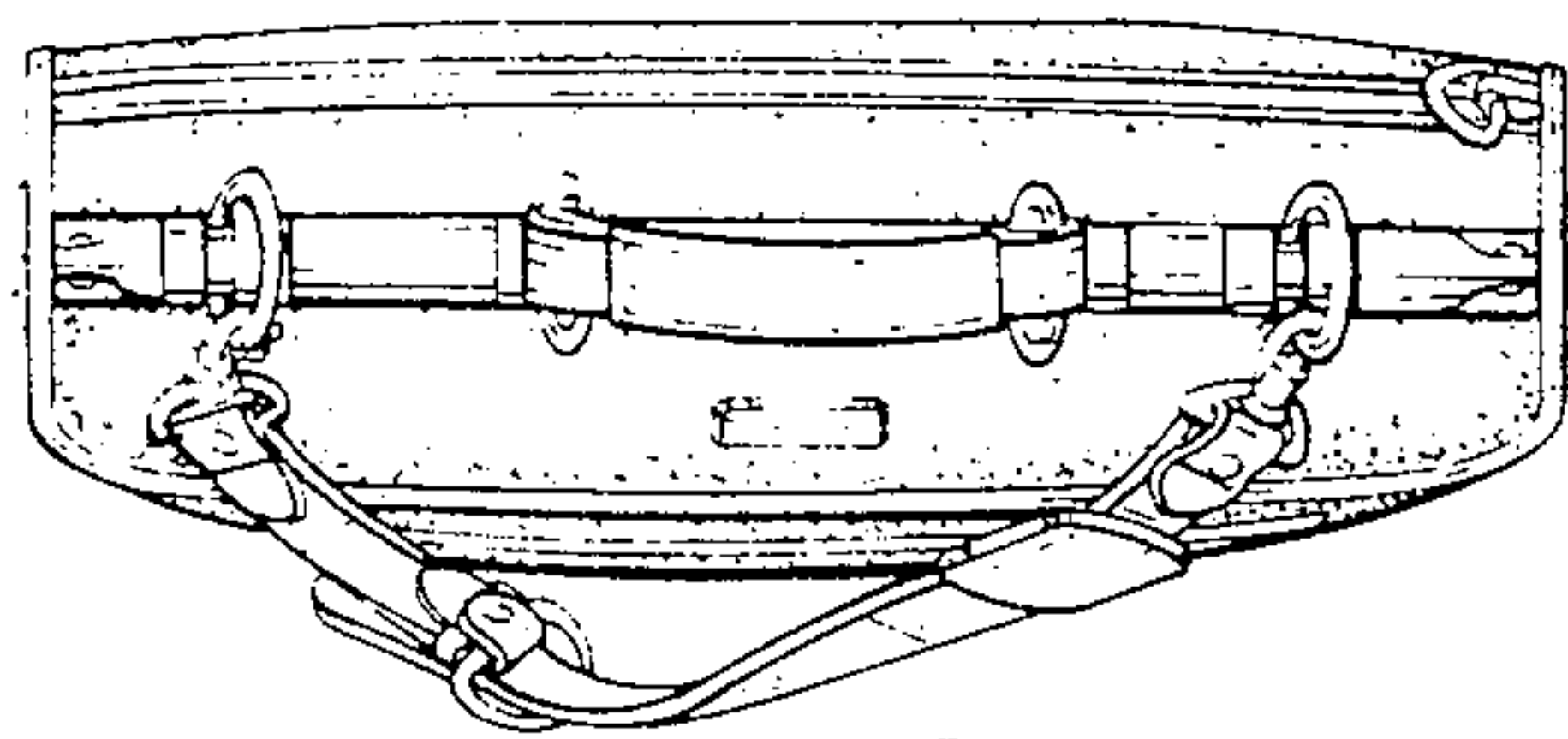

FIG. 8

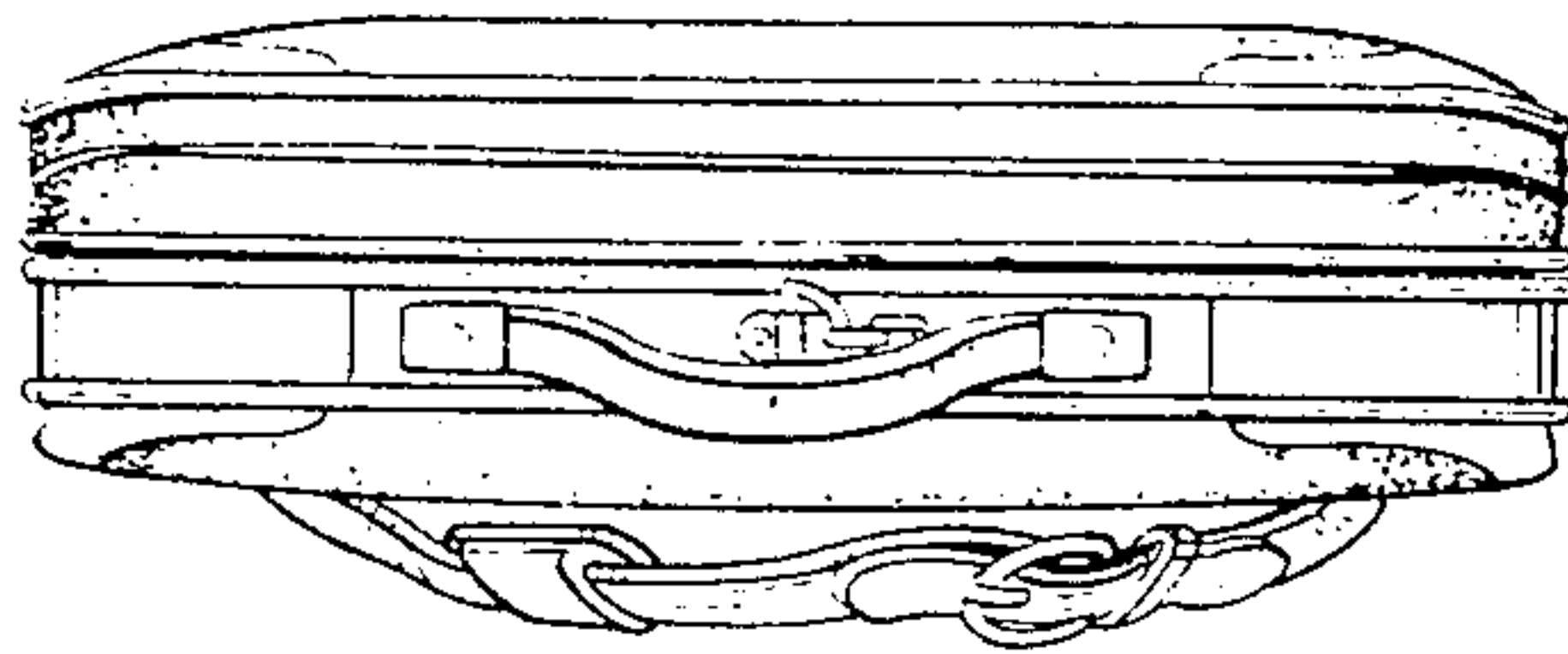

FIG. 10

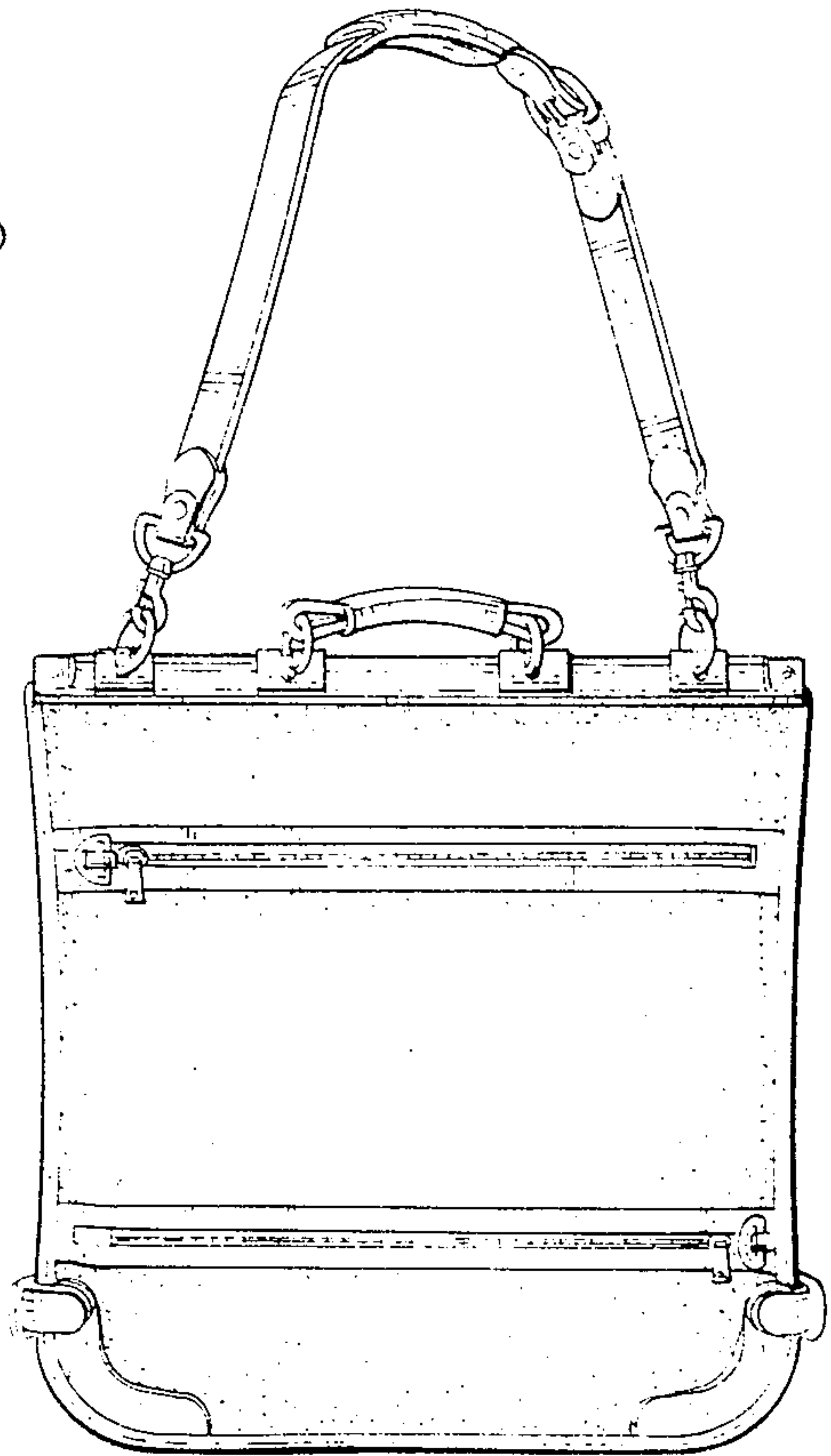

FIG. 11