

- [54] **TYPIST'S COPY STAND**
- [75] Inventors: **Michael J. Szablak; Glen E. Tomblin,**
both of Winchester, Va.
- [73] Assignee: **Rubbermaid Commercial Products,**
Inc., Winchester, Va.
- [**] Term: **14 Years**
- [21] Appl. No.: **397,513**
- [22] Filed: **Jul. 12, 1982**
- [52] U.S. Cl. **D19/91; D19/52**
- [58] Field of Search **D19/91, 52, 90, 86;**
D6/180; 40/341, 352, 357; 248/452; 281/42

3,484,072	12/1969	Wilkin	248/452
3,694,727	9/1971	Wilkin	281/42
4,267,656	5/1981	Solomon	40/352

FOREIGN PATENT DOCUMENTS

446681	3/1949	Italy	40/357
--------	--------	-------------	--------

Primary Examiner—George P. Word
Attorney, Agent, or Firm—Renner, Kenner, Greive & Bobak Co.

[57] **CLAIM**

The ornamental design for a typist's copy stand, as shown and described.

DESCRIPTION

FIG. 1 is a perspective view of a typist's copy stand embodying our new design and comprising a base supporting an upwardly inclined platen.

FIG. 2 is a front elevational view thereof.

FIG. 3 is a sectional view on line 3—3 of FIG. 2.

FIG. 4 is a top plan view of the base detached from the platen.

FIG. 5 is a bottom plan view of the base; and

FIG. 6 is a left side elevational view of the typist's copy stand.

[56] **References Cited**
U.S. PATENT DOCUMENTS

1,305,305	6/1919	Pitts .	
1,612,192	12/1926	Johnson .	
1,884,639	10/1932	Fensky et al. .	
1,908,874	5/1933	Van Alstine .	
2,000,558	5/1935	Dawson et al.	120/33
2,572,731	10/1951	Keith	40/352
2,763,241	9/1956	Waggoner	40/352
2,891,195	11/1883	Weinschenk .	

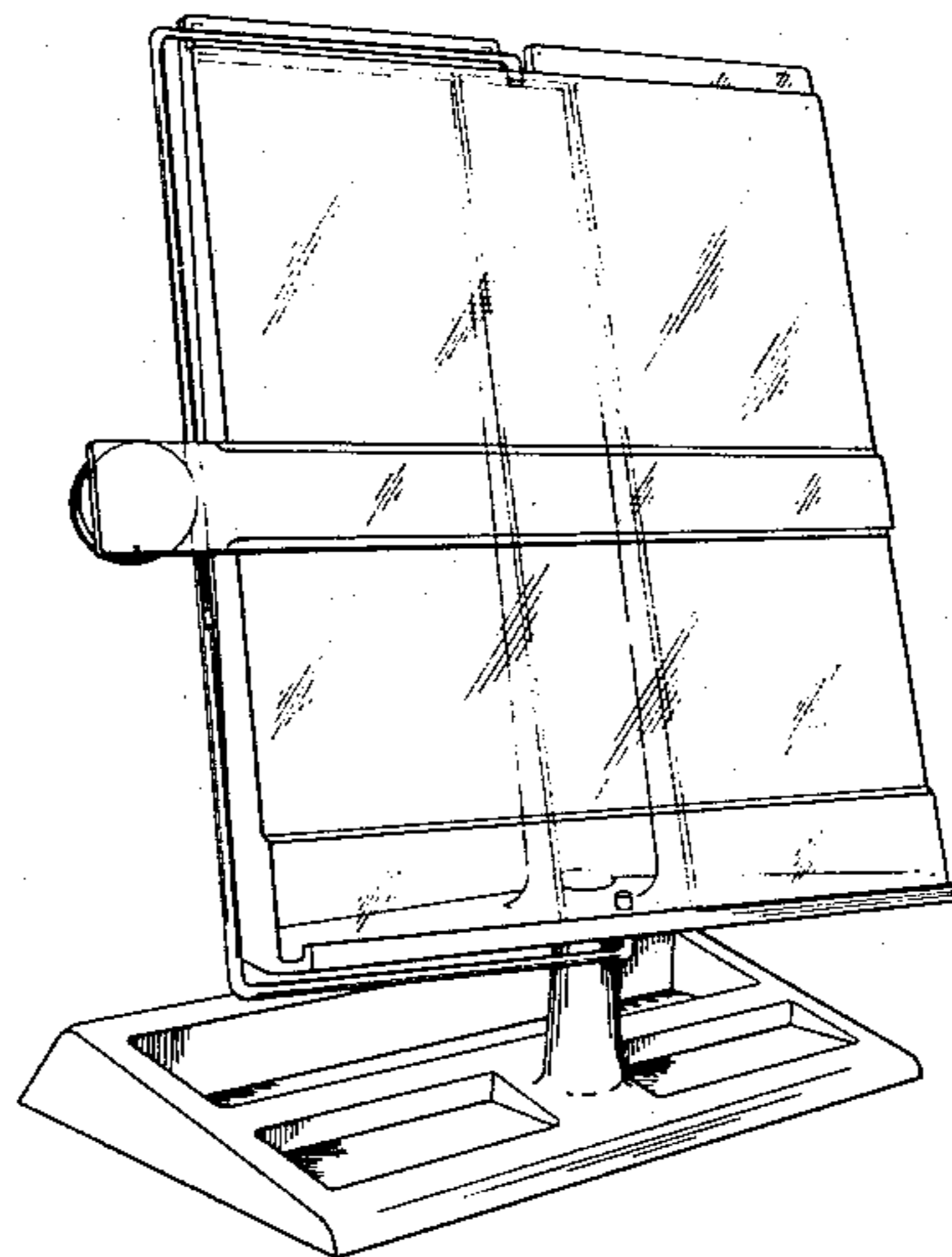

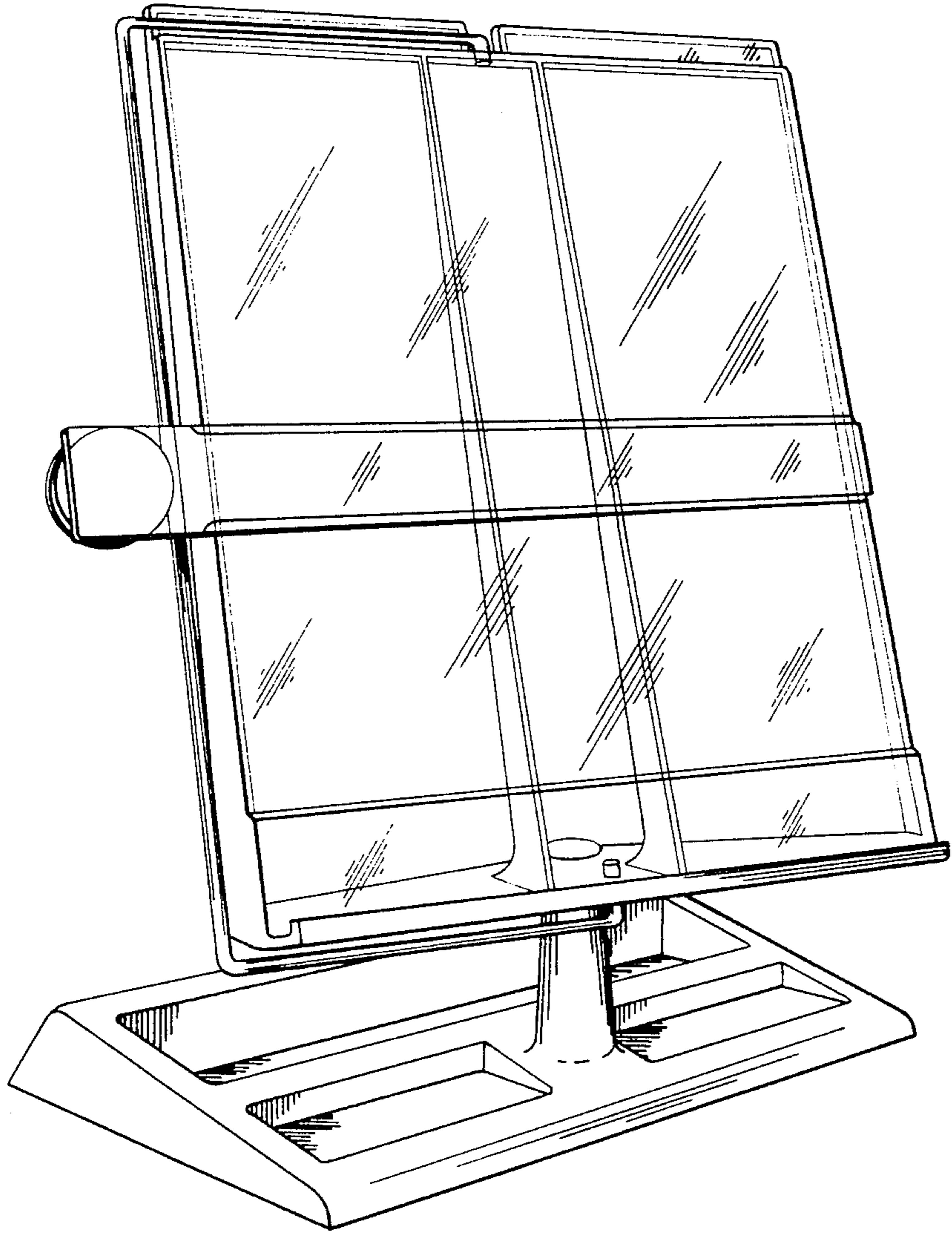

FIG. 1

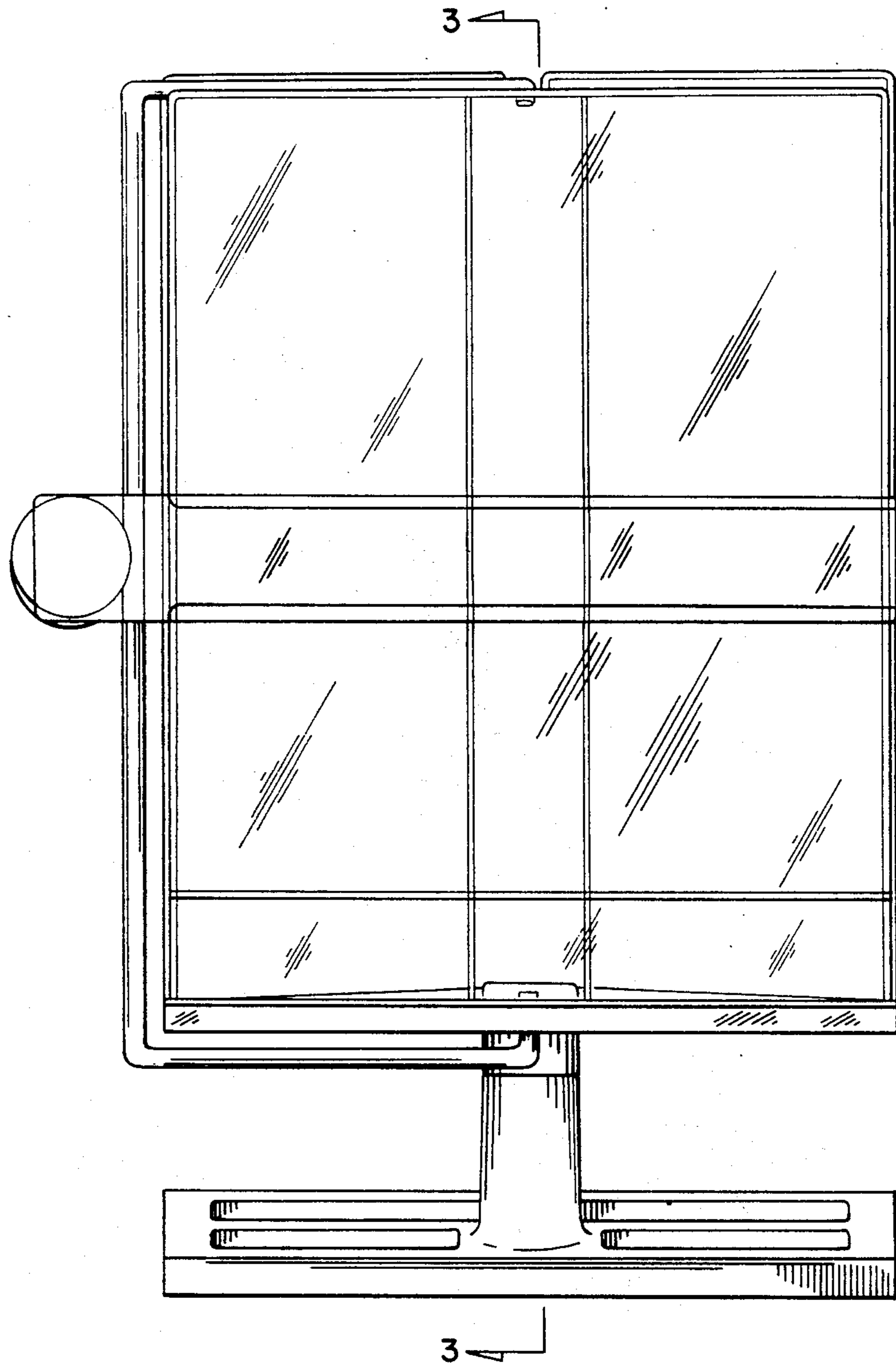

FIG. 2

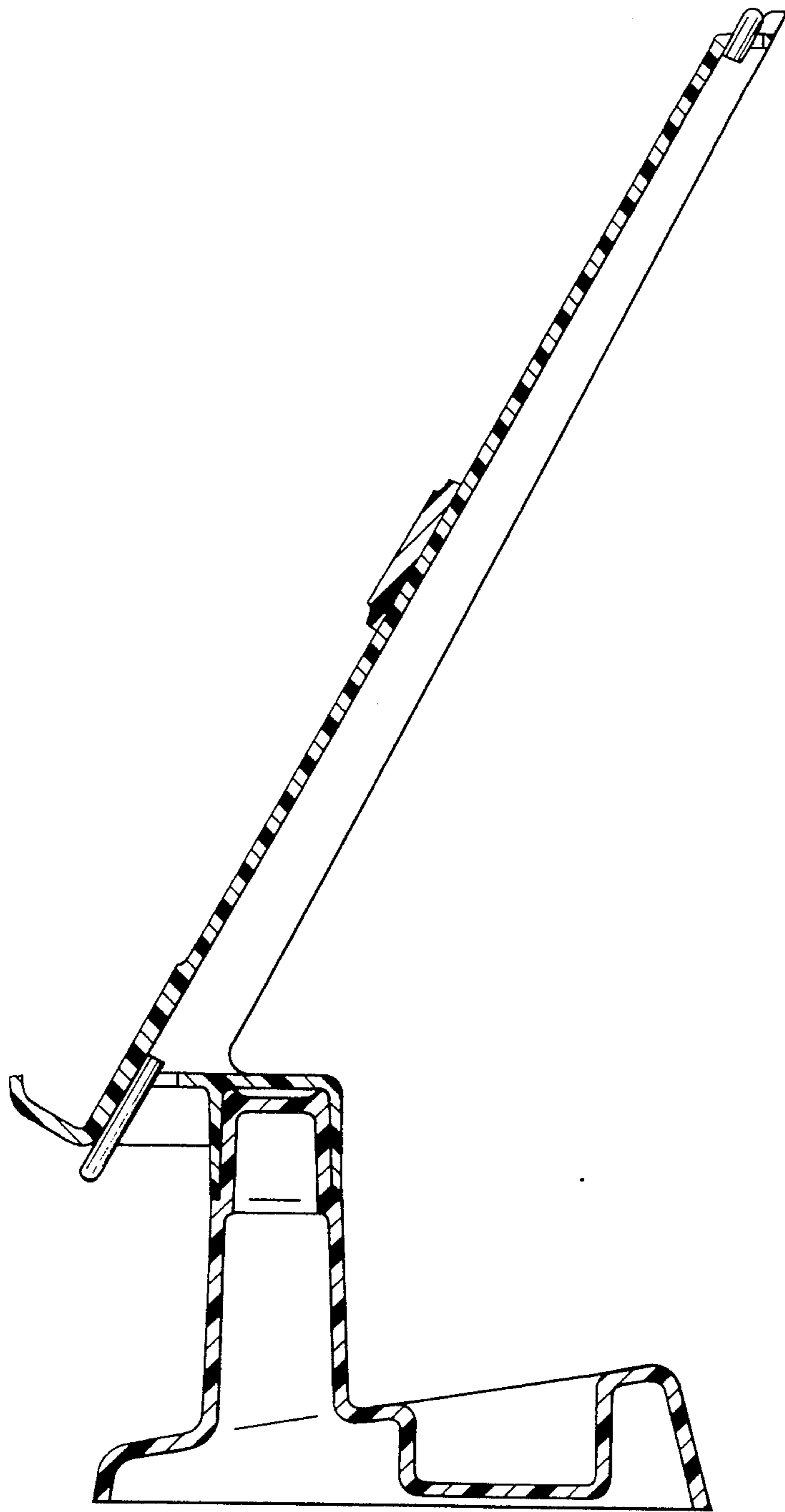

FIG. 3

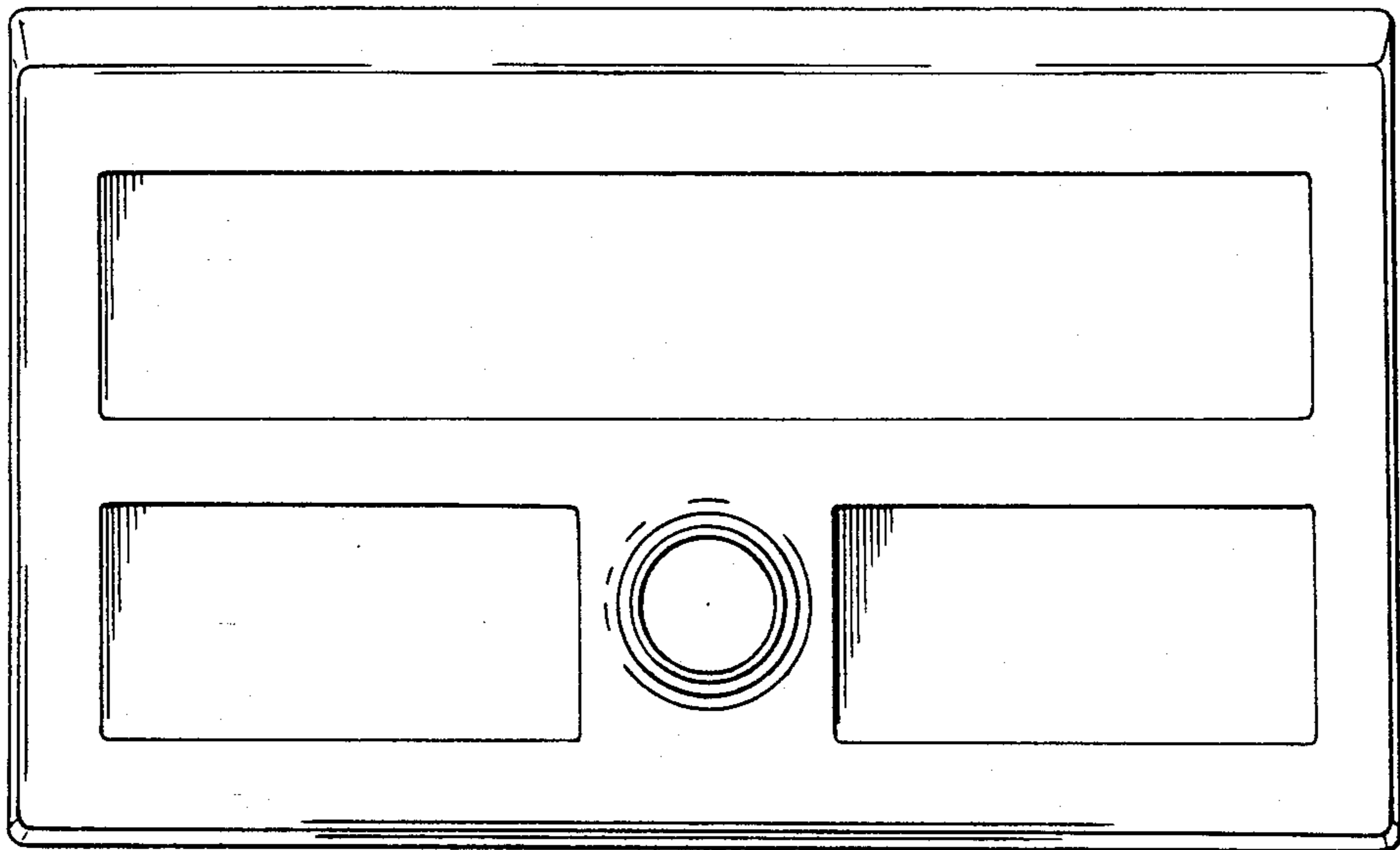

FIG. 4

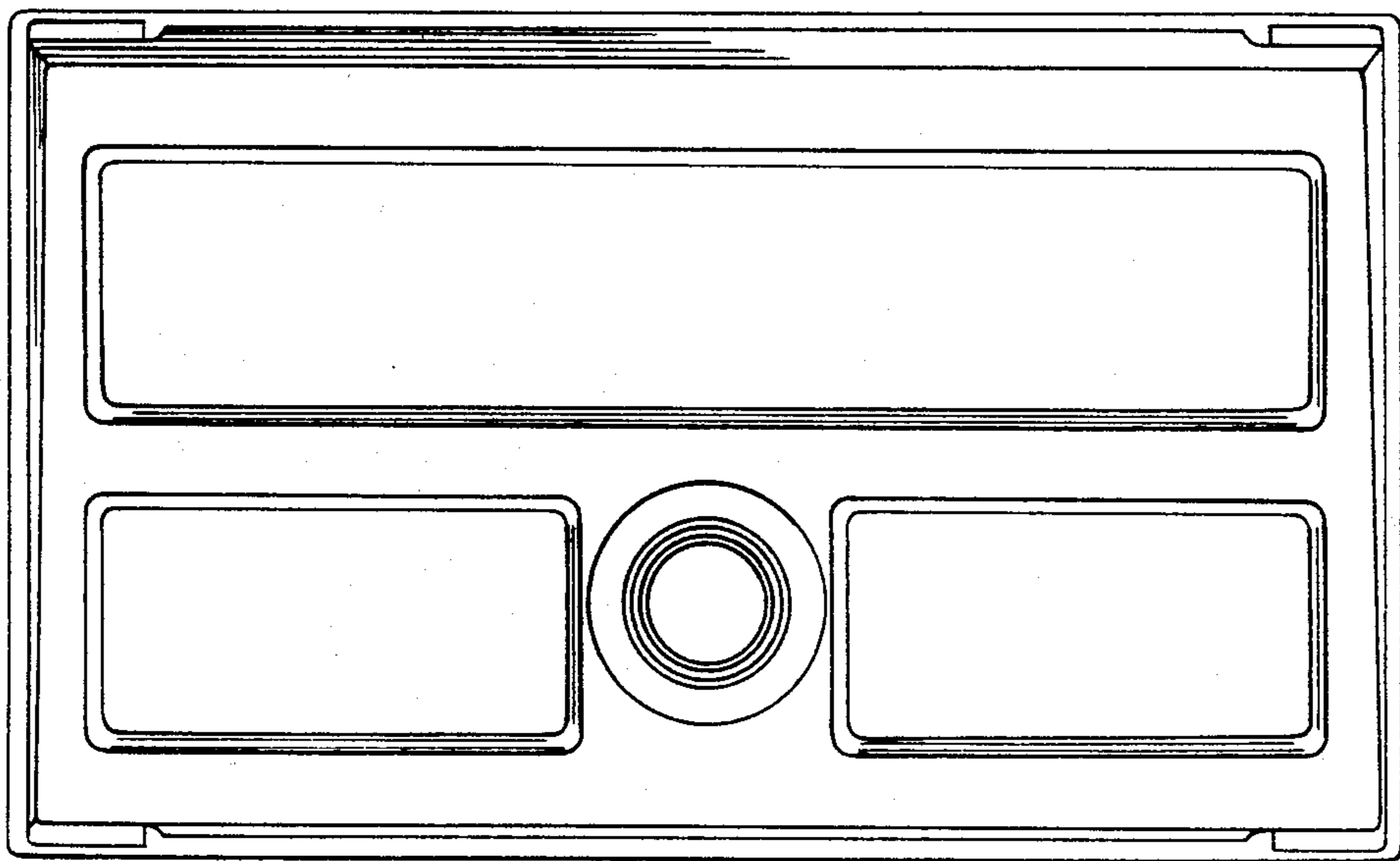

FIG. 5

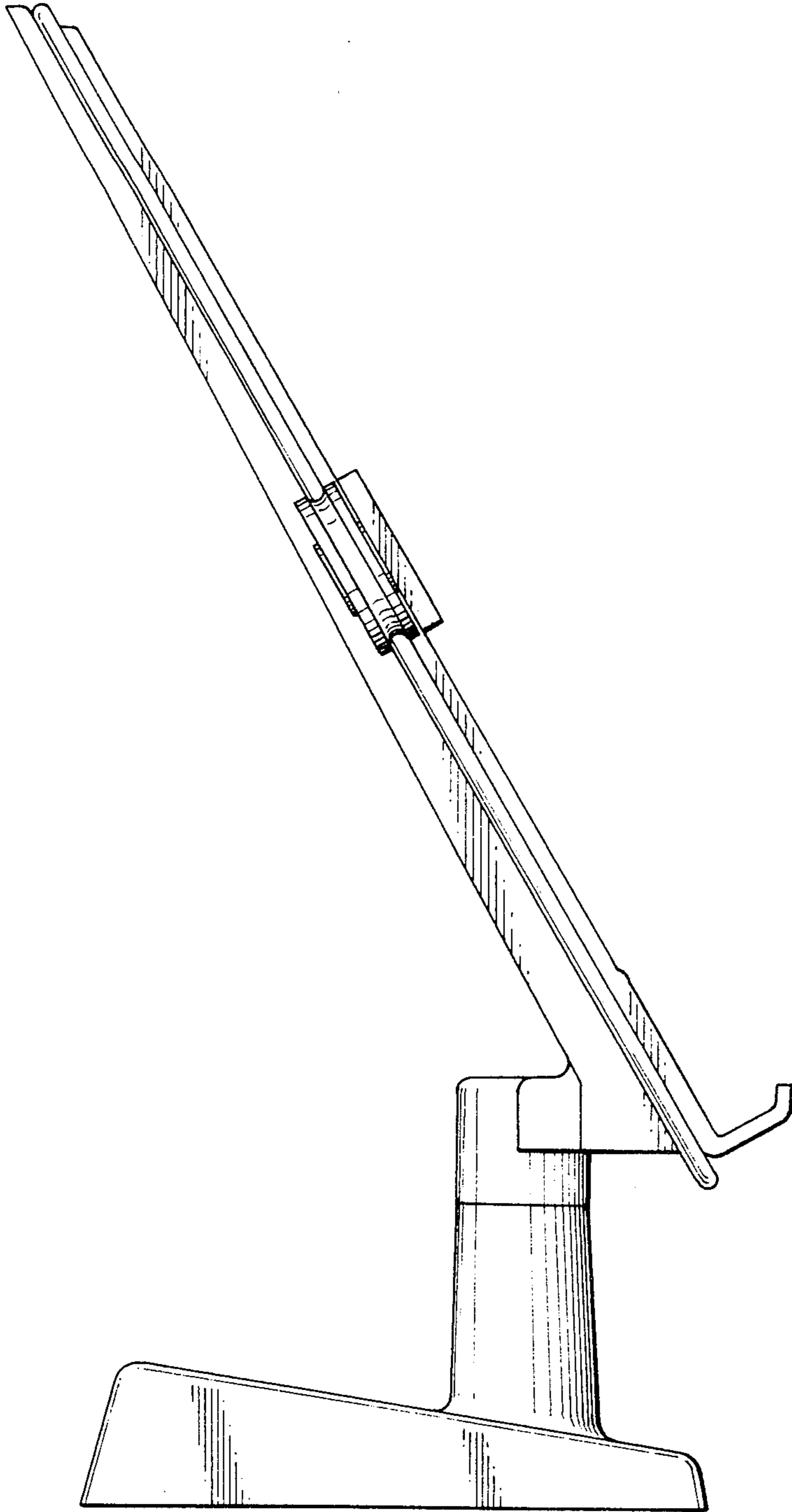

FIG. 6