

[54] FLOATING SEAT

[76] Inventor: Klaus P. H. Maertin, 7 Villiers Pl., Dee Why West, New South Wales 2099, Australia

[**] Term: 14 Years

[21] Appl. No.: 420,204

[22] Filed: Sep. 20, 1982

[52] U.S. Cl. D21/237

[58] Field of Search D21/237, 238; 441/130, 441/131, 81

- 2491314 4/1982 France.
- 249325 3/1926 Great Britain.
- 2542589 9/1984 France.
- 575615 2/1946 Great Britain.
- 576709 4/1946 Great Britain.
- 623044 5/1949 Great Britain.
- 634994 3/1950 Great Britain.
- 686682 1/1963 Great Britain.
- 742969 1/1956 Great Britain.

Primary Examiner—James M. Gandy
Assistant Examiner—Kay H. Chin
Attorney, Agent, or Firm—Ladas & Parry

[56] References Cited

U.S. PATENT DOCUMENTS

- D. 187,313 2/1960 Denyer D21/237
- 2,173,963 4/1938 Eubank 441/131
- 2,435,497 2/1948 Hajduk 441/131
- 2,959,796 6/1960 De Sander 9/312
- 3,581,328 6/1971 Smith 9/310G
- 4,021,873 5/1977 Francois 9/2A

FOREIGN PATENT DOCUMENTS

- 85813 4/1977 Australia.
- 1025949 4/1966 Great Britain.
- 1280543 11/1961 France.
- 1354237 1/1964 France.
- 1468187 3/1977 Great Britain.
- 1488672 10/1977 Great Britain.
- 1756765 10/1970 West Germany.
- 2288030 5/1976 France.

[57] CLAIM

The ornamental design for a floating seat, as shown.

DESCRIPTION

FIG. 1 is a top perspective view of a floating seat;
FIG. 2 is a top plan view thereof;
FIG. 3 is a bottom plan view thereof;
FIG. 4 is a view in section taken along line IV—IV of FIG. 2.
FIG. 5 is a side elevation view thereof looking in the direction of arrow 5 of FIG. 2;
FIG. 6 is a side elevation view thereof looking in the direction of arrow 6 of FIG. 2; and
FIG. 7 is a side elevation view thereof looking in the direction of arrow 7 of FIG. 2.
The broken lines showing of the connecting members in FIGS. 1, 4, 5, 6 and 7 are for illustrative purposes only.

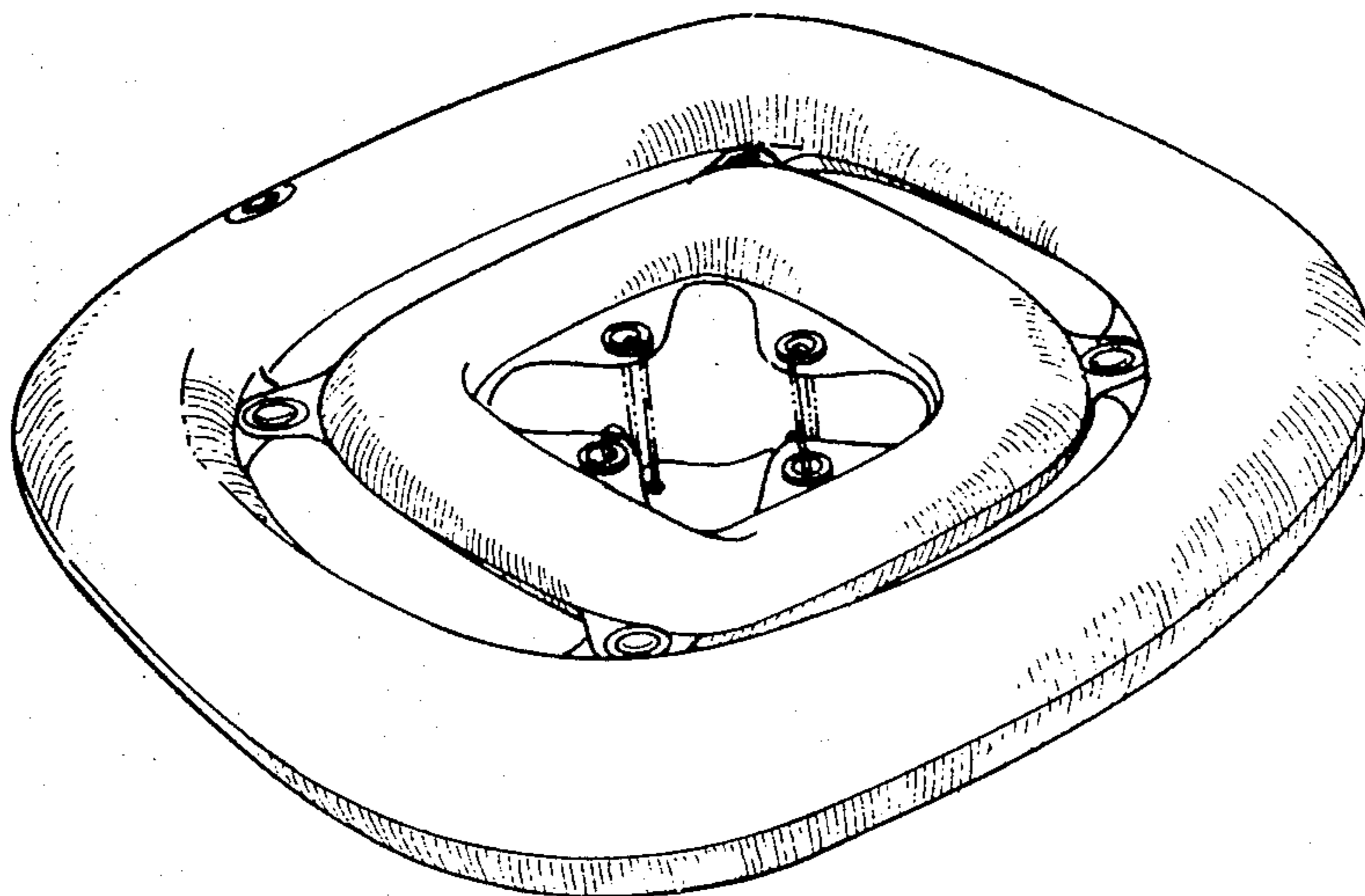

FIG. 1

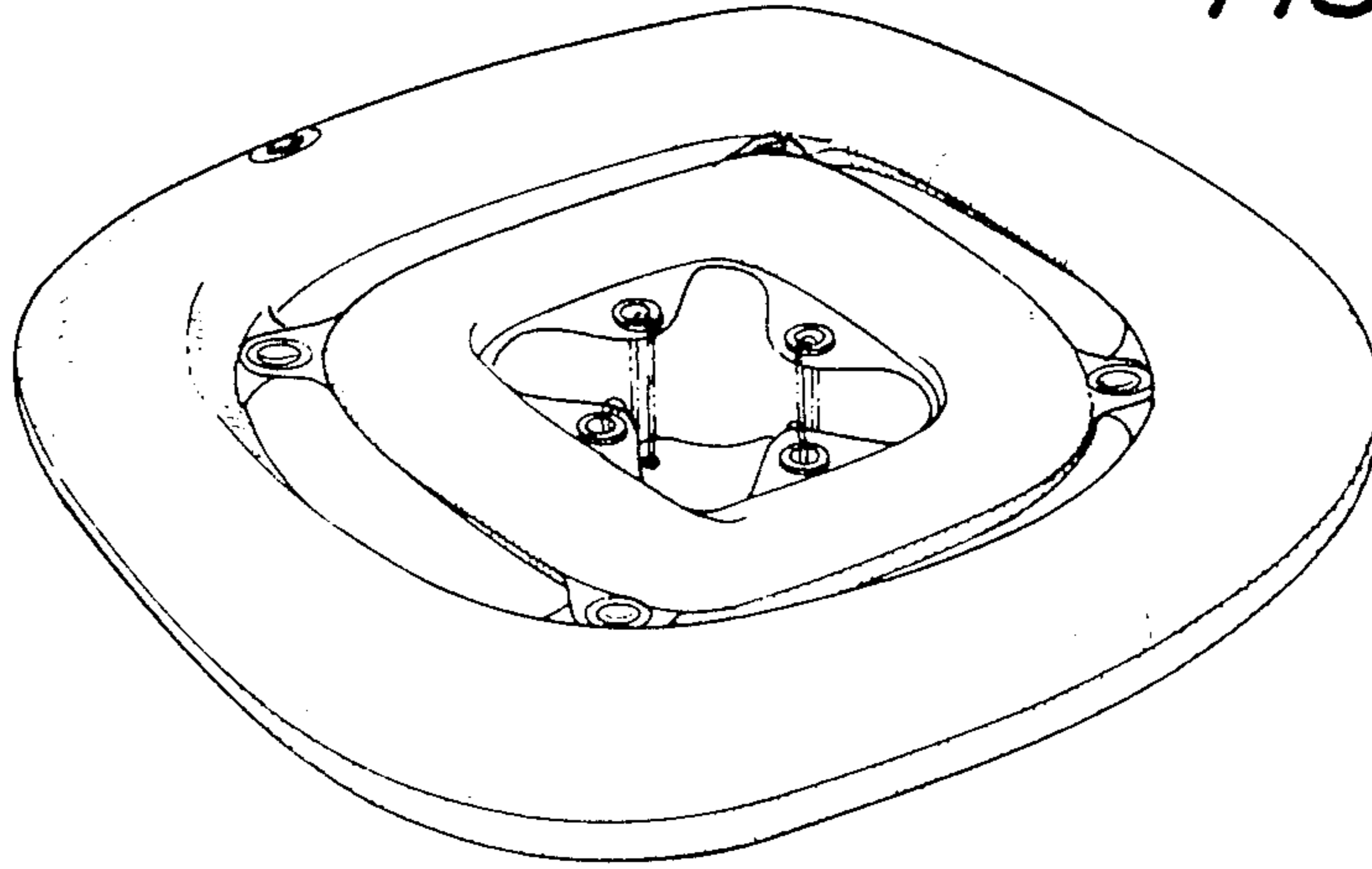
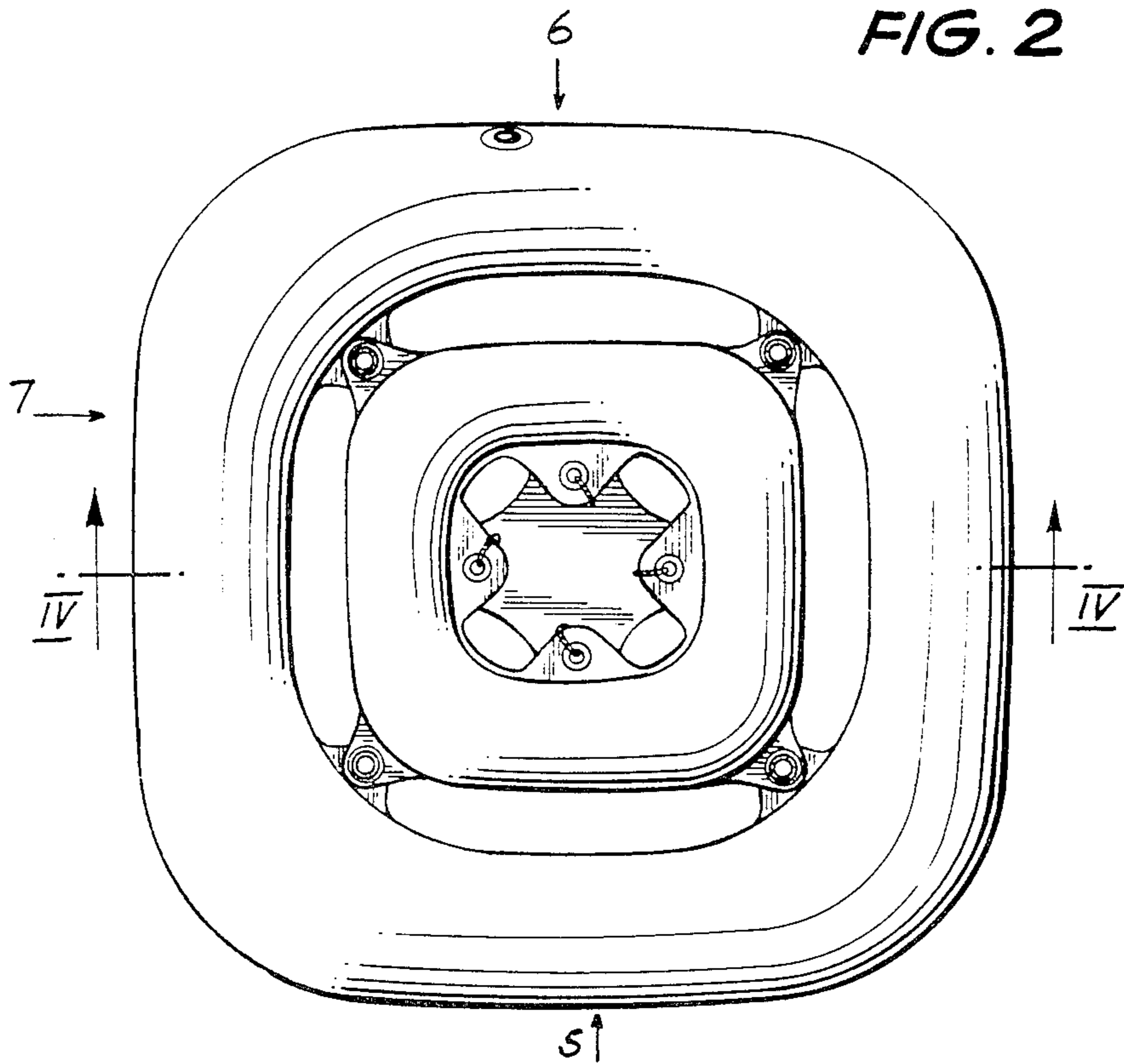

FIG. 2



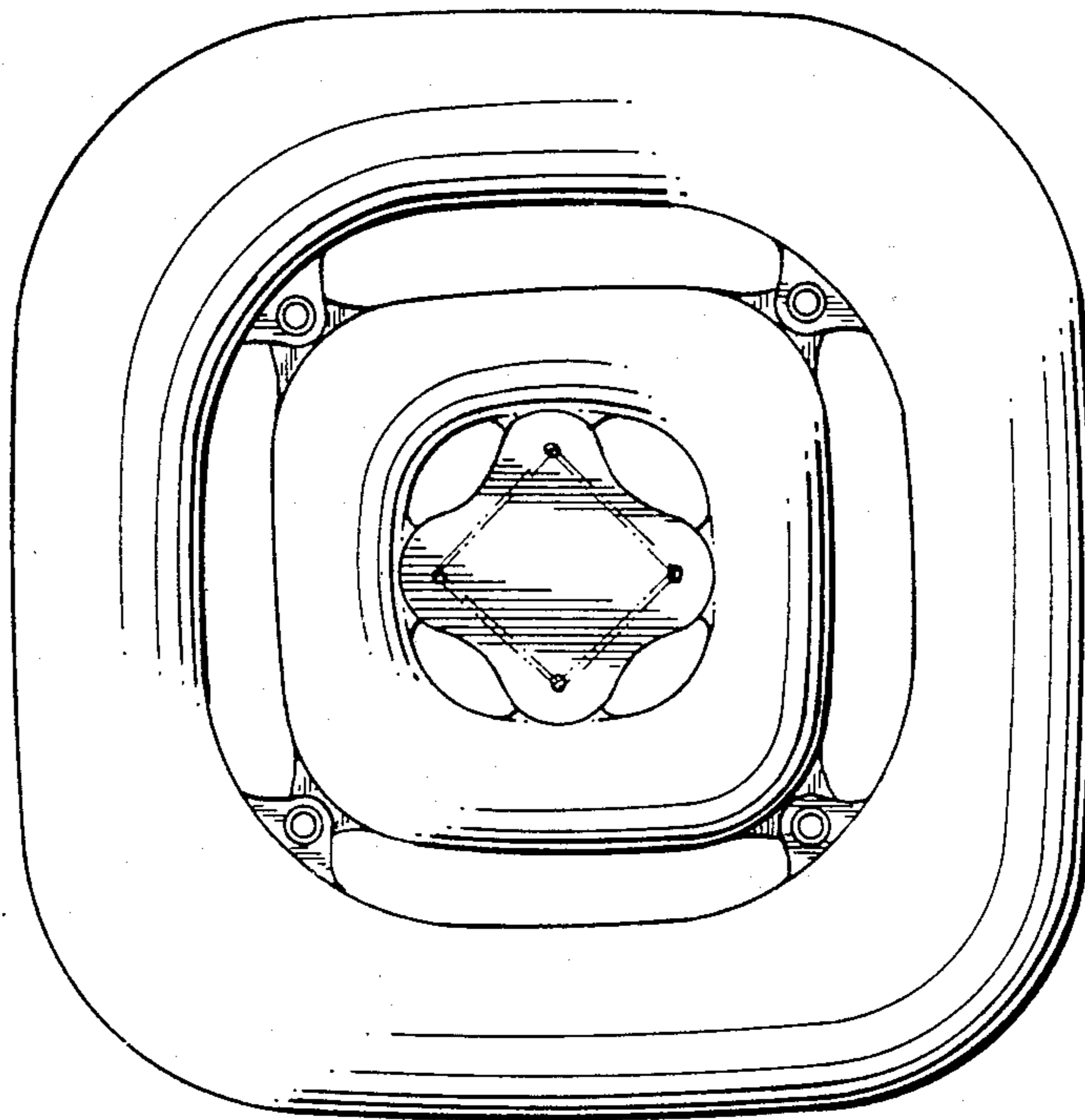
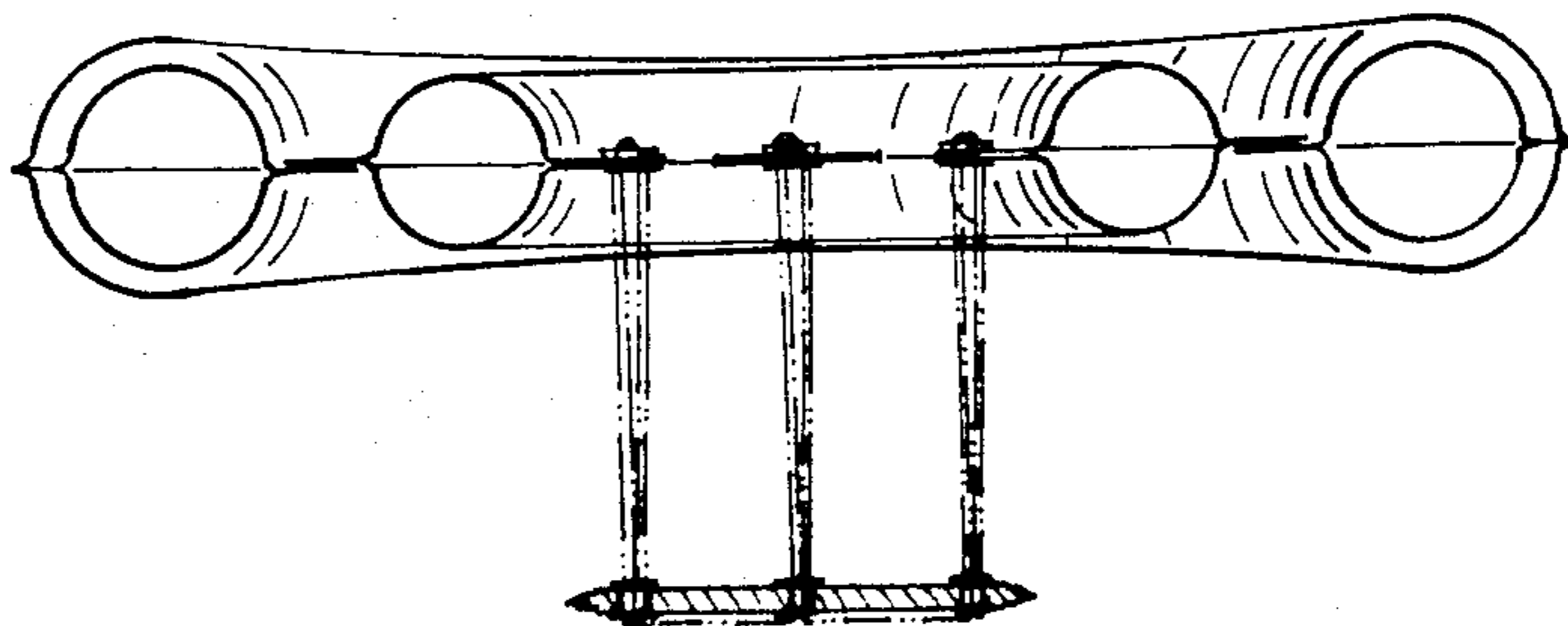

FIG. 3

FIG. 4



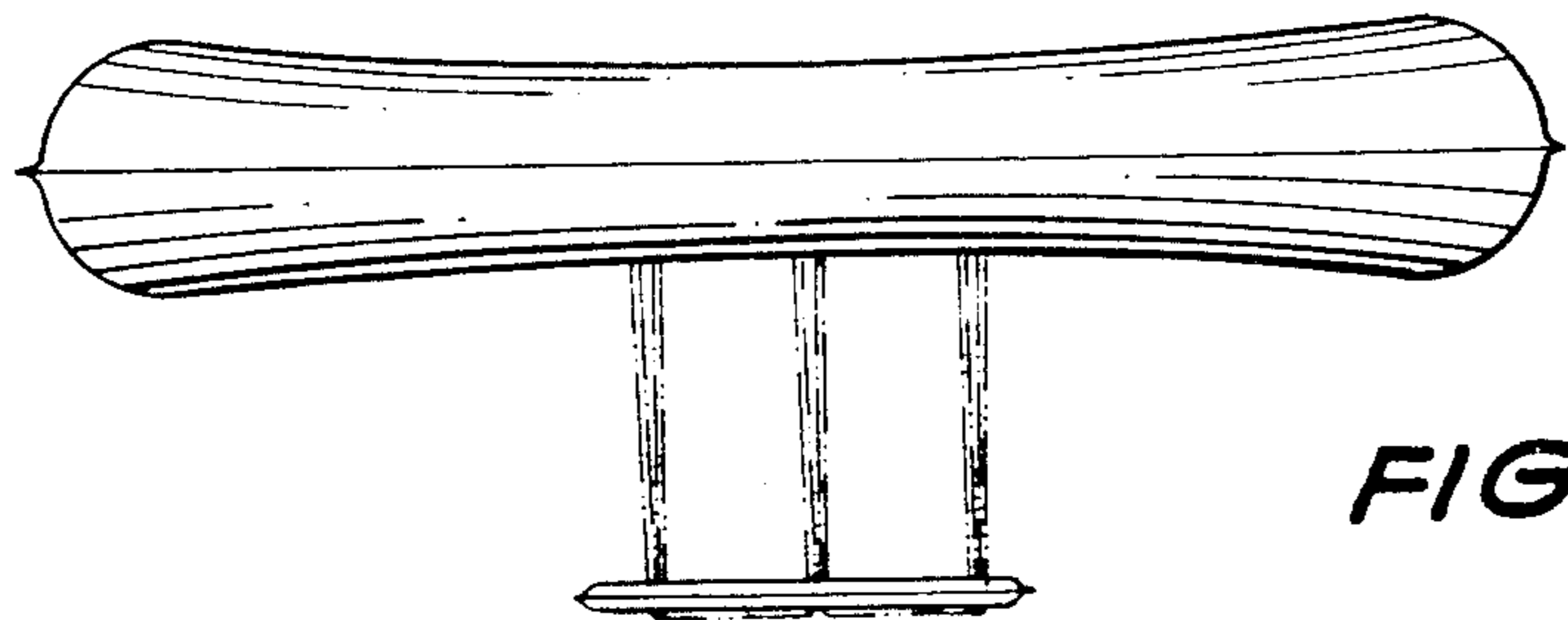

FIG. 5

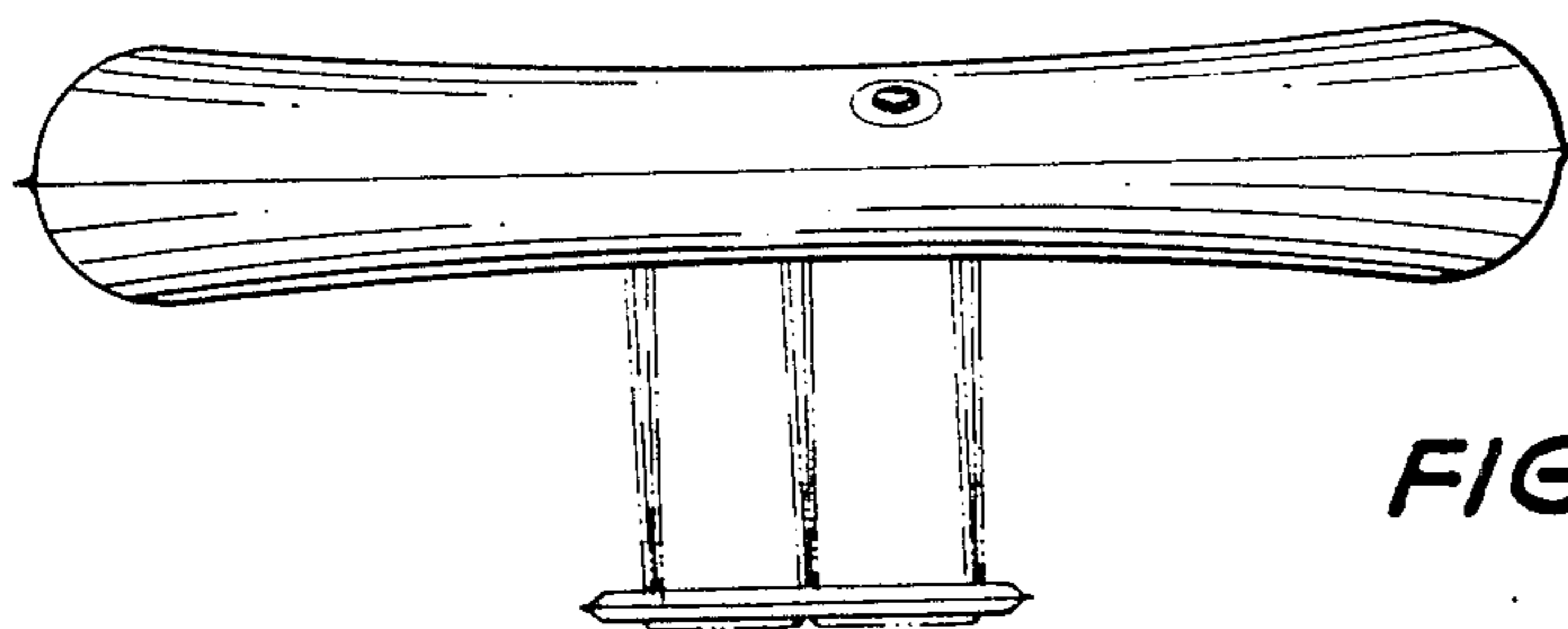

FIG. 6

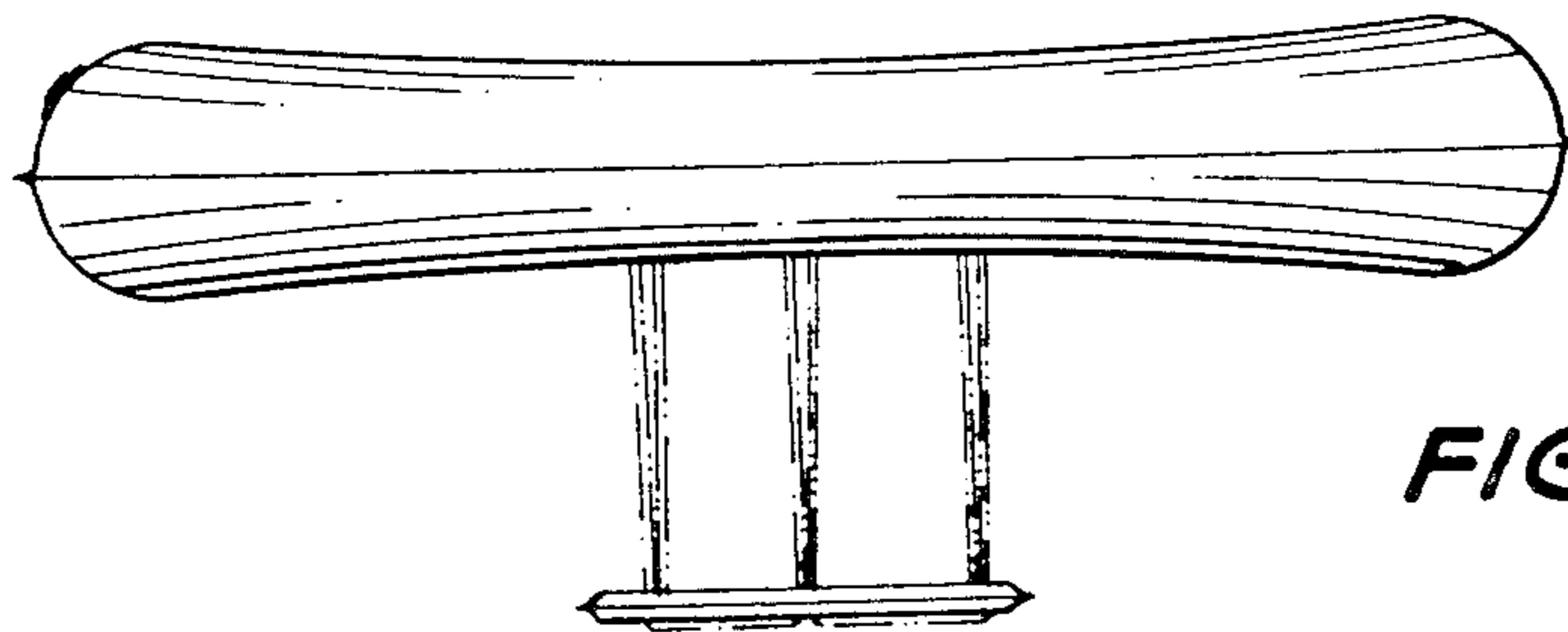

FIG. 7