

[54] **STAPLE GUN HAVING A STAPLE STORAGE COMPARTMENT**

[75] **Inventor: George Hillinger, Los Angeles, Calif.**

[73] **Assignee: Alltrade Inc., Commerce, Calif.**

[**] **Term: 14 Years**

[21] **Appl. No.: 521,218**

[22] **Filed: Aug. 10, 1983**

[52] **U.S. Cl. D8/49**

[58] **Field of Search D8/49, 50; 227/128, 227/127, 132**

[56] **References Cited**

U.S. PATENT DOCUMENTS

D. 165,414	12/1951	Crosby et al.	D8/49
D. 172,754	8/1954	Marano	D8/49
2,337,479	12/1943	Lindstrom	227/128
2,456,526	12/1948	Morberg	227/132
2,617,096	11/1952	Boroughs	227/127 X

Primary Examiner—Bernard Ansher
Assistant Examiner—Terry Pfeffer
Attorney, Agent, or Firm—William W. Glenny

[57] **CLAIM**

The ornamental design for a staple gun having a staple storage compartment, substantially as shown and described.

DESCRIPTION

FIG. 1 is a left side view of a staple gun showing my new design;
FIG. 2 is a front view thereof;
FIG. 3 is a rear view thereof;
FIG. 4 is a top plan view thereof;
FIG. 5 is a bottom plan view thereof;
FIG. 6 is a right side view thereof; and
FIG. 7 is a fragmentary view of the upper right portion of the staple gun as seen in FIG. 1, showing the door of the storage compartment in open position.
The distinctive feature of my design resides in the provision of a translucent portion in the windowed grip whereby to lighten the appearance of the staple gun.

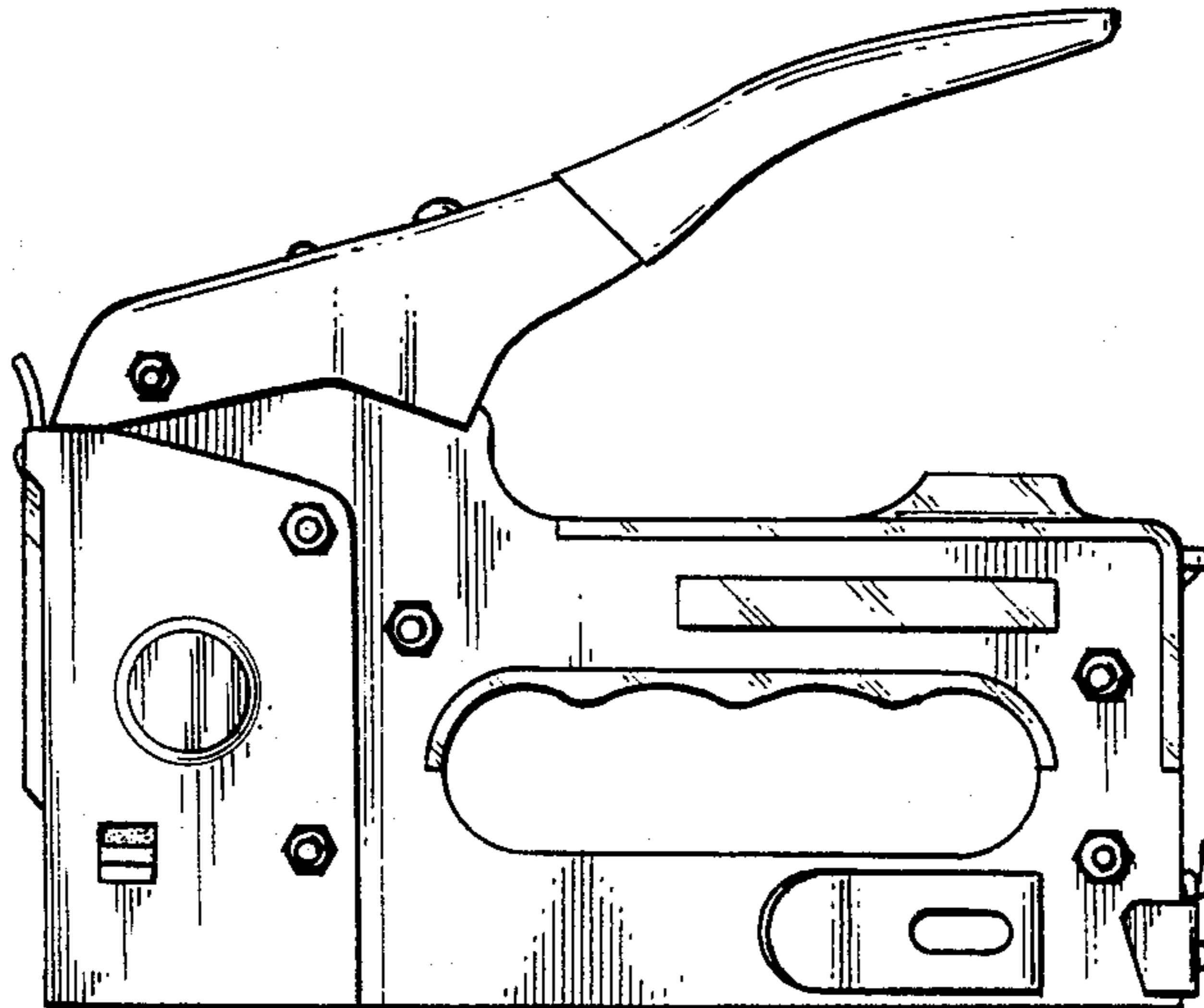

Fig. 4.

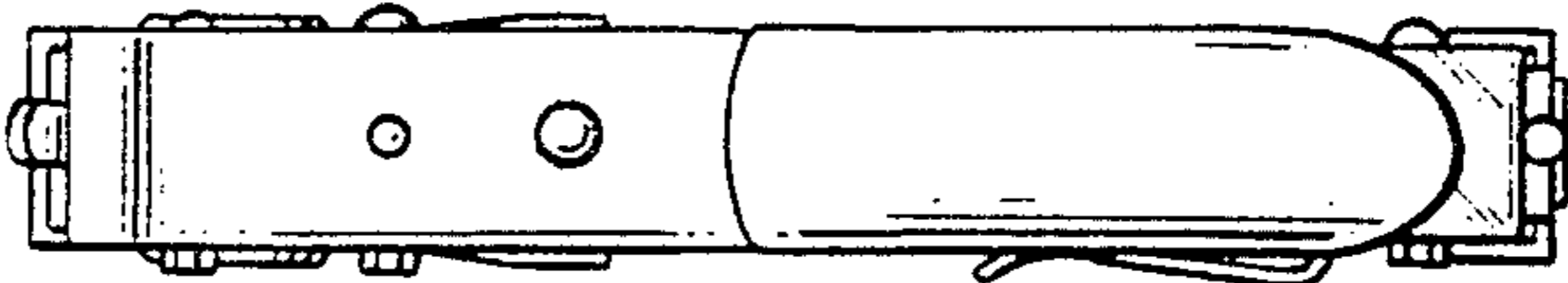

Fig. 2.

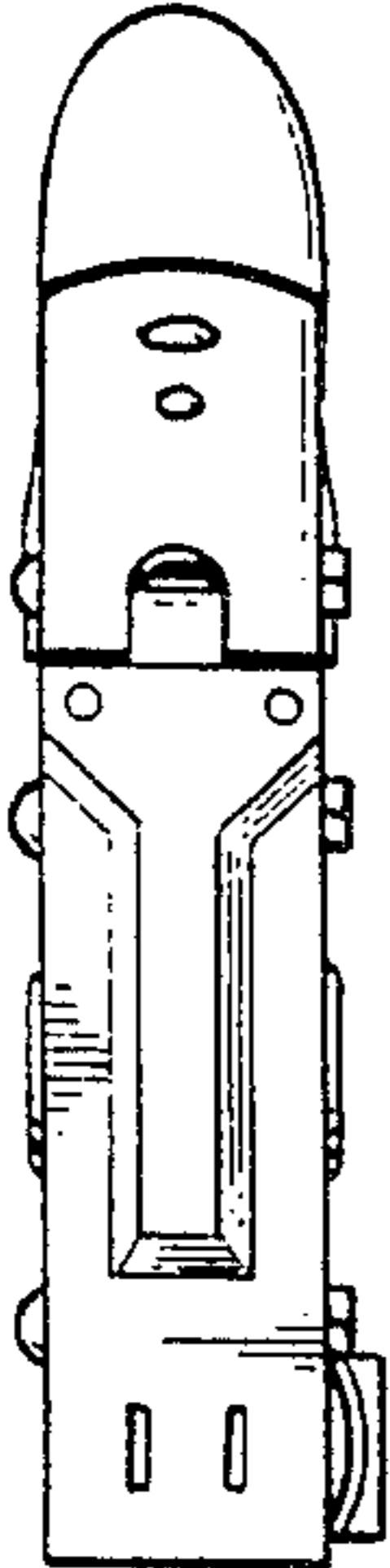

Fig. 1.

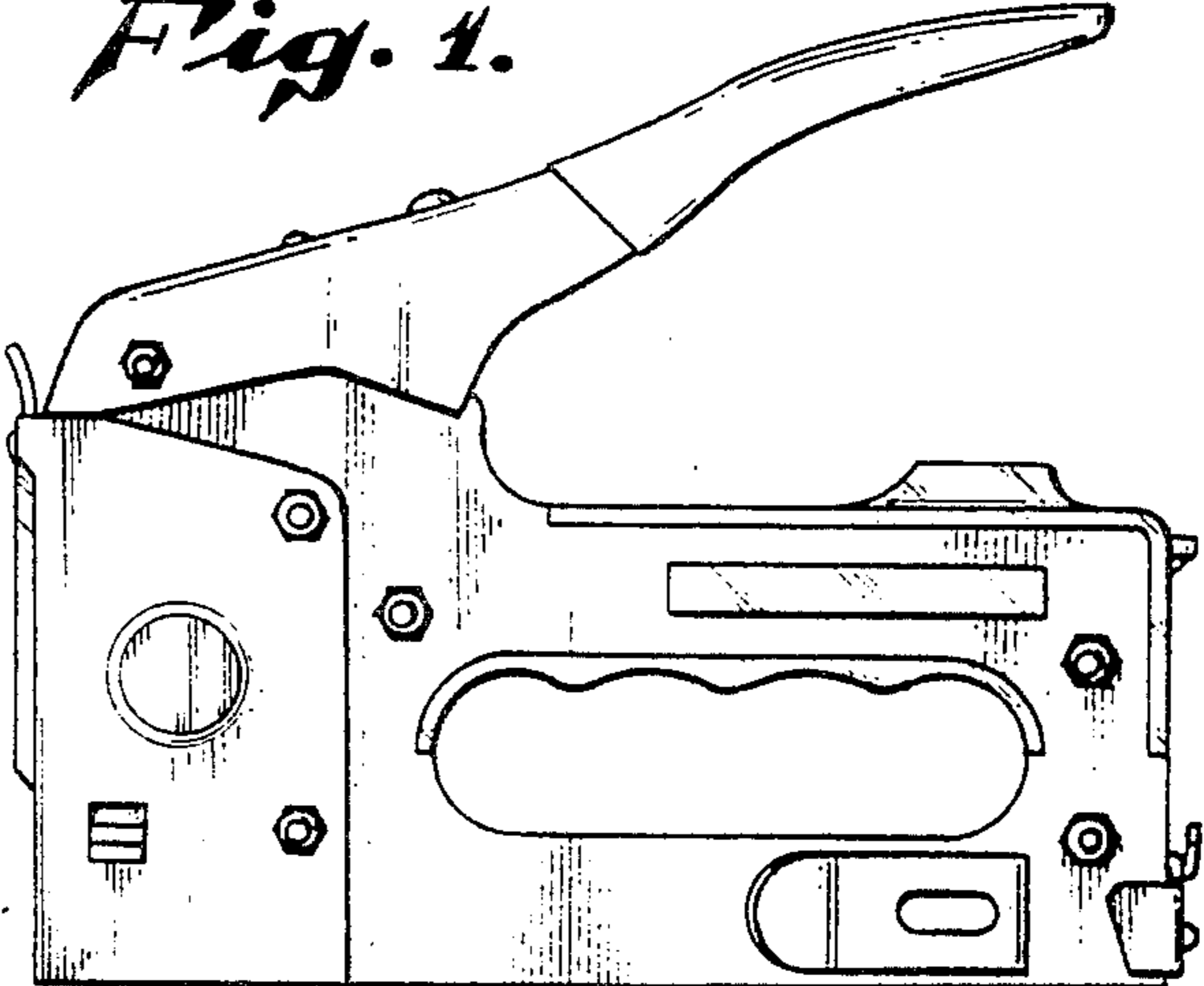

Fig. 5.

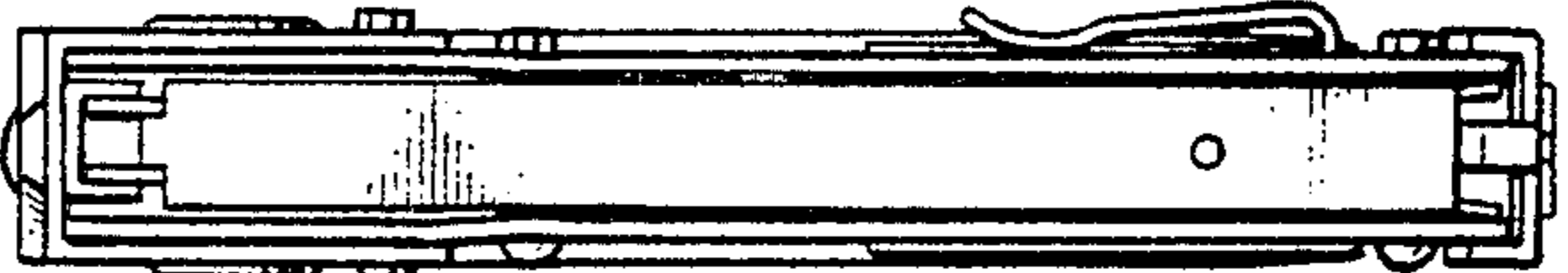

Fig. 3.

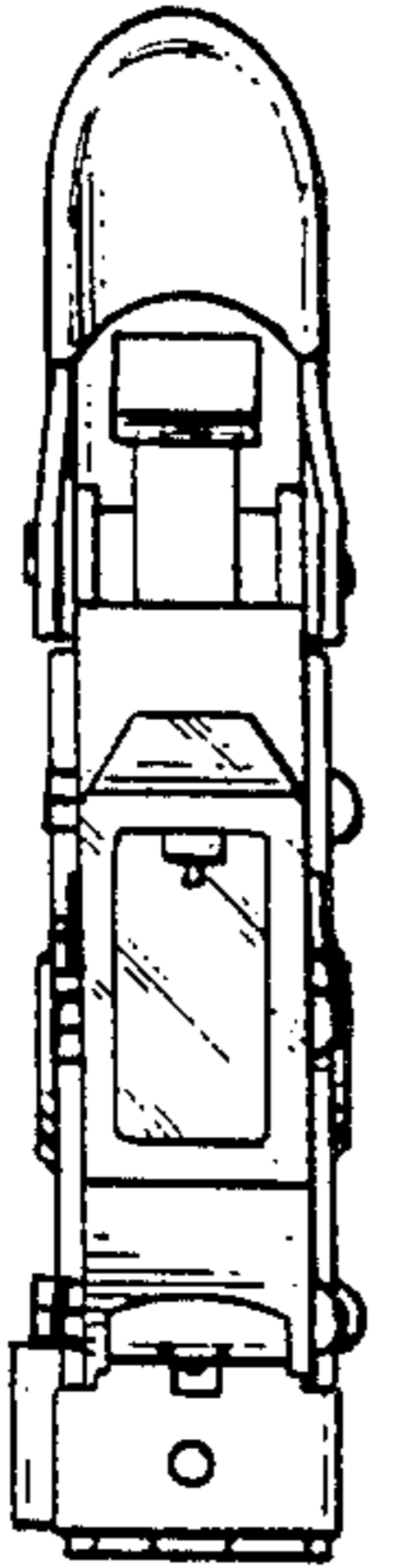

Fig. 6.

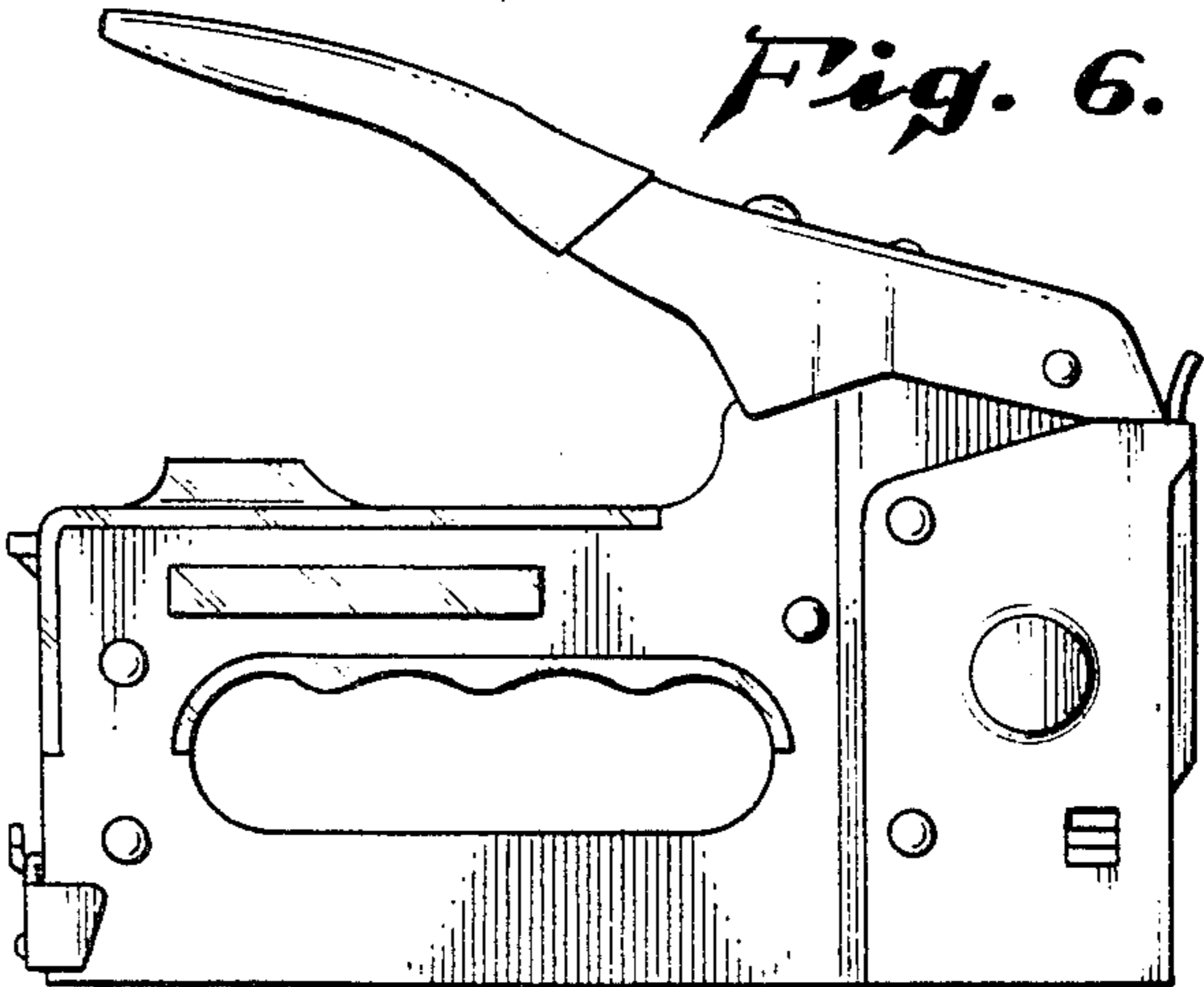

Fig. 7.

