

[54] APPARATUS FOR POPPING CORN

- [75] Inventor: William C. Cesaroni, Glenview, Ill.  
[73] Assignee: Dart Industries Inc., Northbrook, Ill.  
[\*\*] Term: 14 Years  
[21] Appl. No.: 458,090  
[22] Filed: Jan. 14, 1983  
[52] U.S. Cl. .... D7/325; D7/360  
[58] Field of Search ..... D7/325, 323, 354, 355,  
D7/356, 360; 99/323.5-323.11

[56] References Cited

U.S. PATENT DOCUMENTS

D. 206,674	1/1967	Hughes	.....	D7/325
D. 241,601	9/1976	Cook	.....	D7/325
D. 273,168	3/1984	Bowen et al.	.....	D7/354
3,611,910	10/1971	Hughes	.....	99/323.5
4,149,455	4/1979	Ross	.....	99/323.5
4,332,188	6/1982	Rhear	.....	99/323.5

OTHER PUBLICATIONS

Retailing Home Furnishings, Jul. 11, 1977, Sec 2, p. 1, West Bend Cornpopper.

Primary Examiner—Bernard Ansher  
Assistant Examiner—Linda Titolo  
Attorney, Agent, or Firm—Gregory J. Mancuso

[57] CLAIM

The ornamental design for an apparatus for popping corn, substantially as shown.

DESCRIPTION

FIG. 1 is a front perspective view of an apparatus for popping corn showing my new design; FIG. 2 is a top plan view thereof; FIG. 3 is a front elevational view thereof; FIG. 4 is a right side elevational view thereof; FIG. 5 is a left side elevational view thereof; FIG. 6 is a rear elevational view thereof; and FIG. 7 is a bottom plan view thereof.

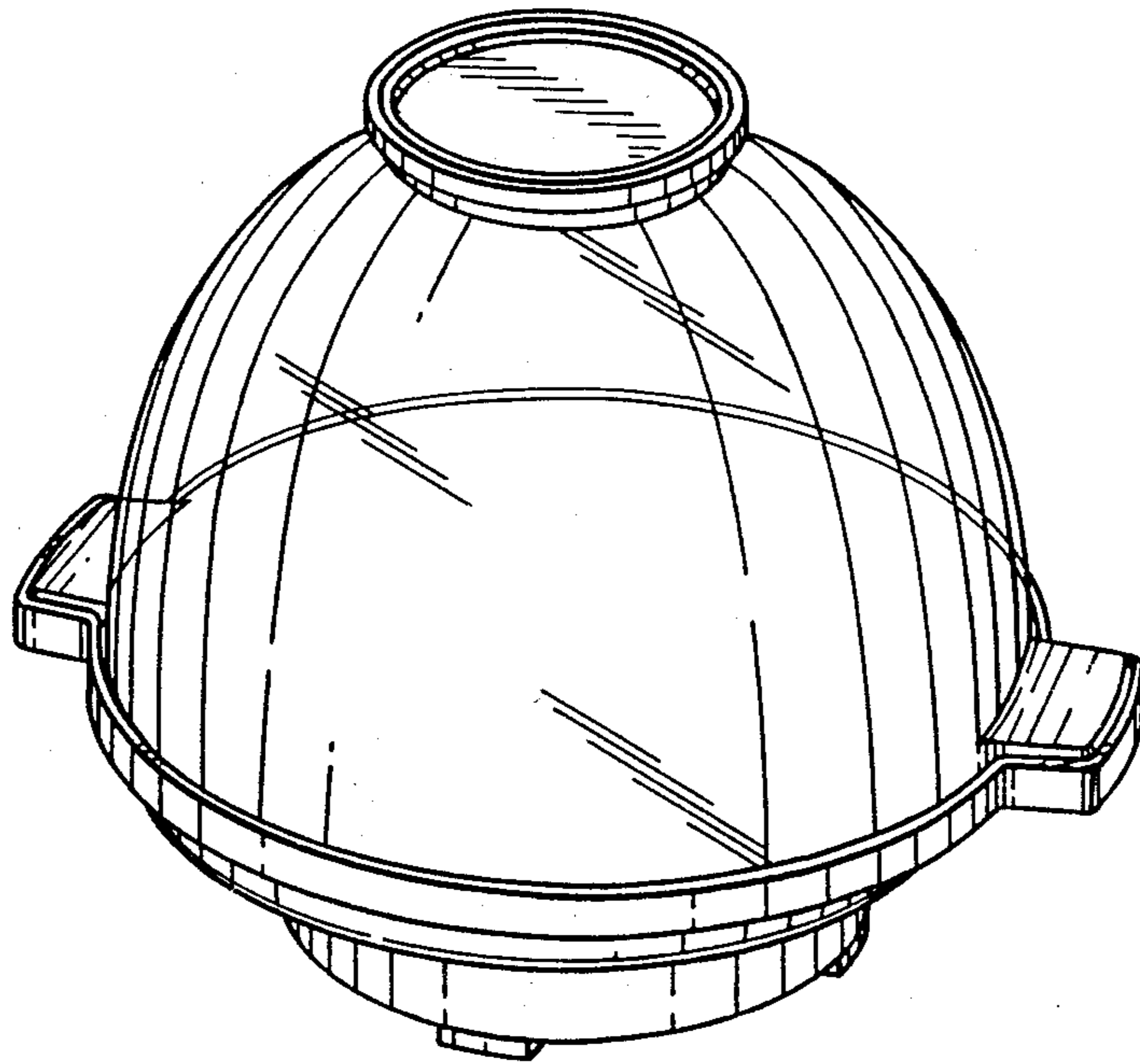

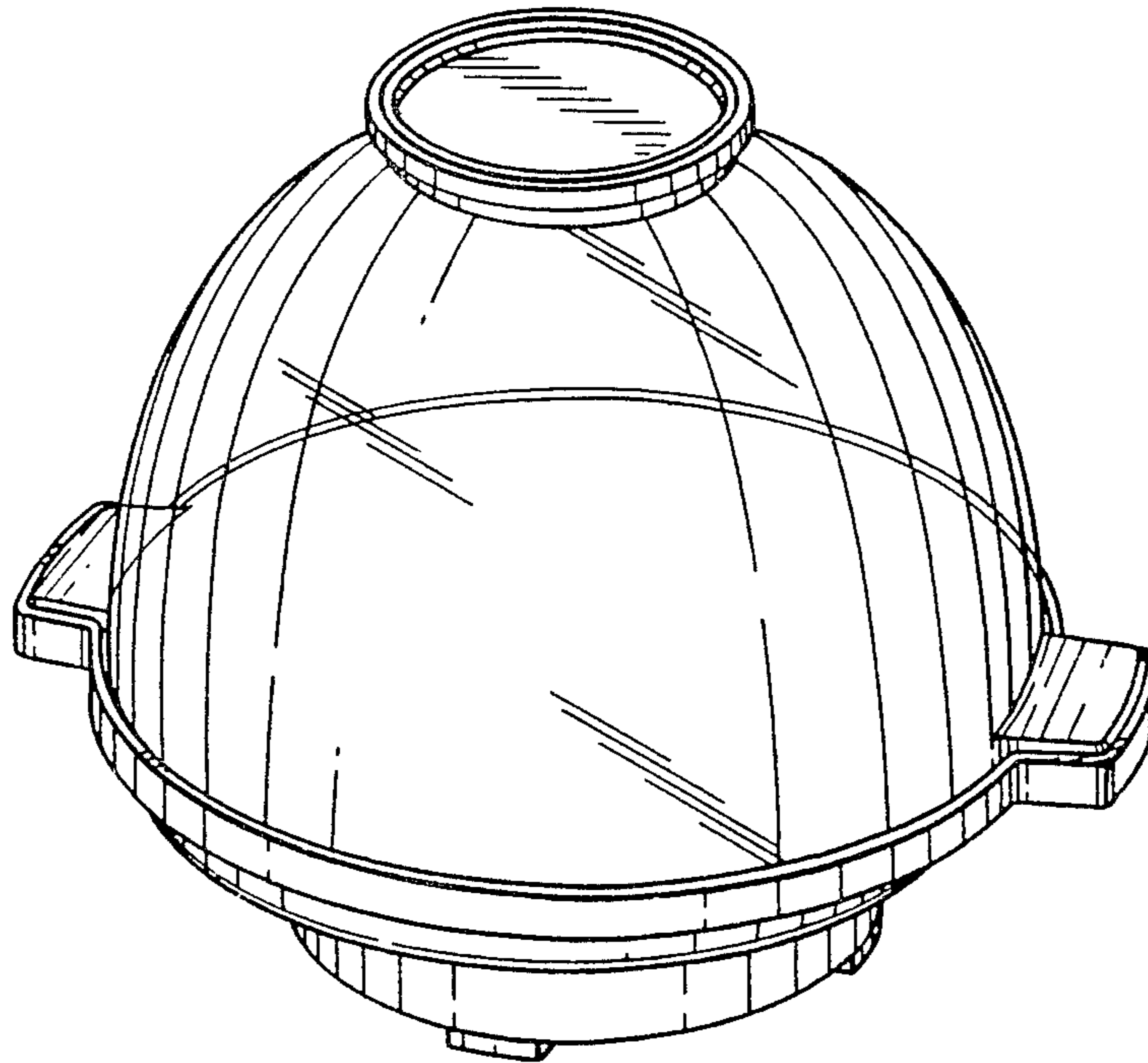

FIG. 1

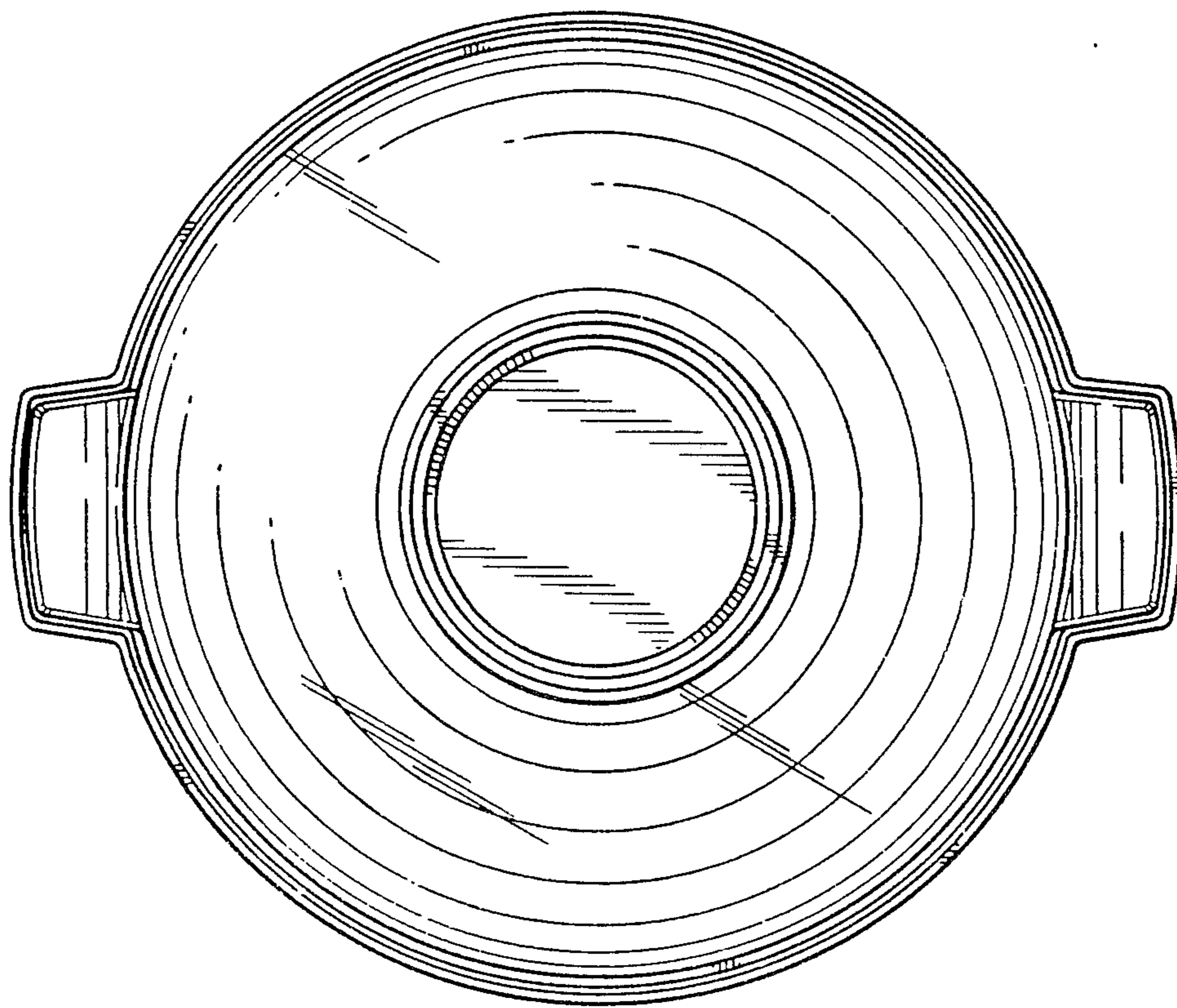

FIG. 2

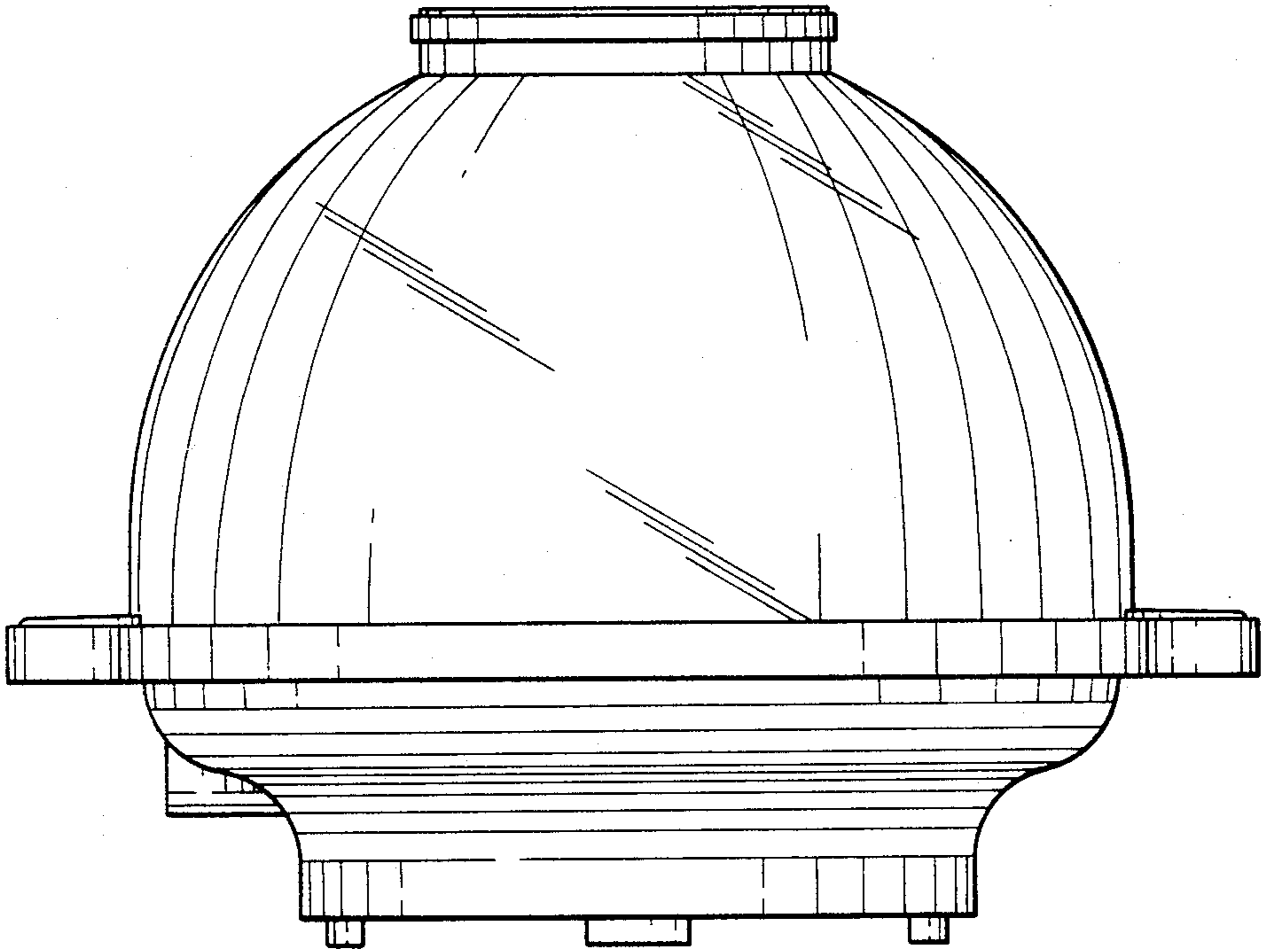

FIG. 3

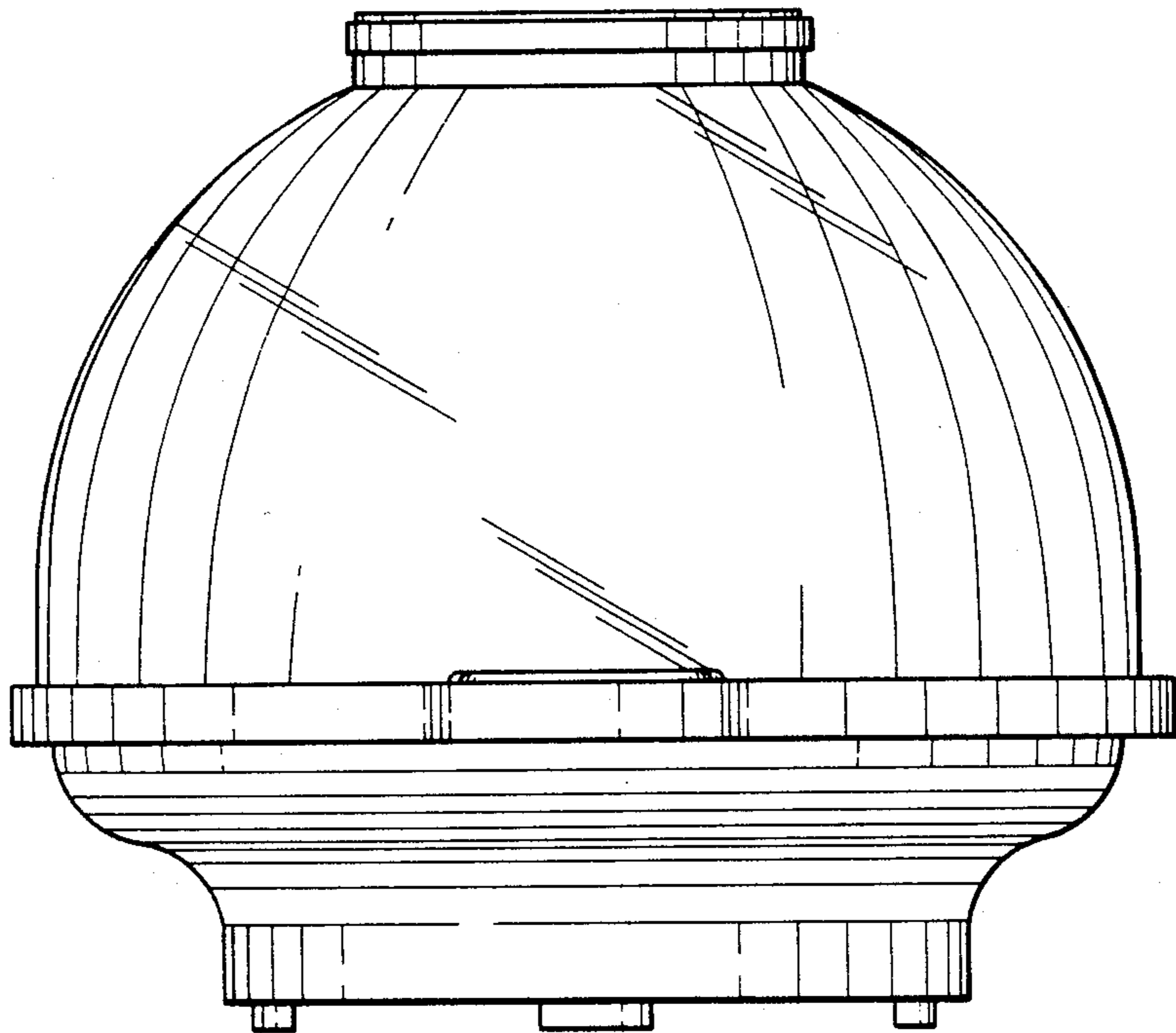

FIG. 4

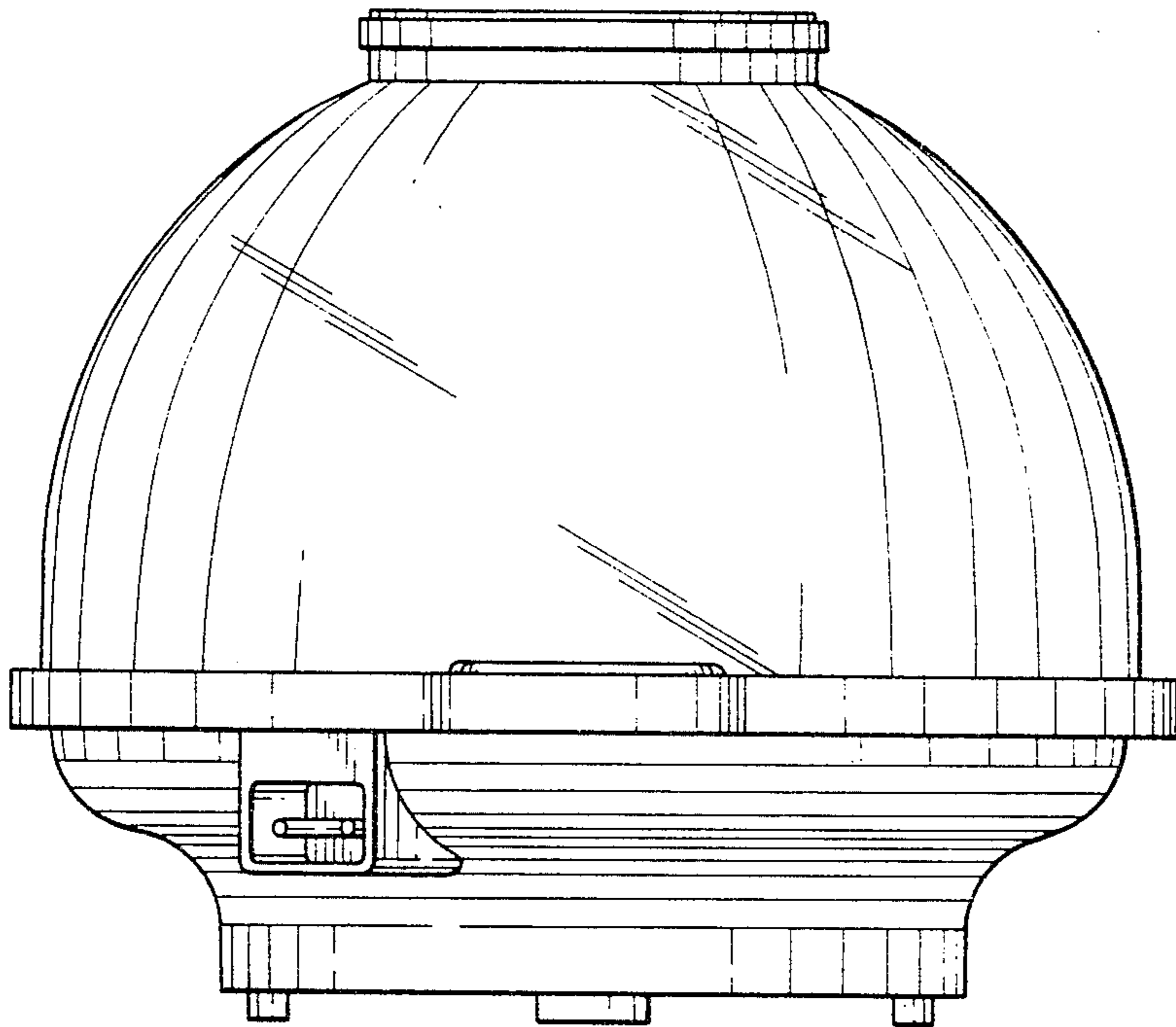

FIG. 5

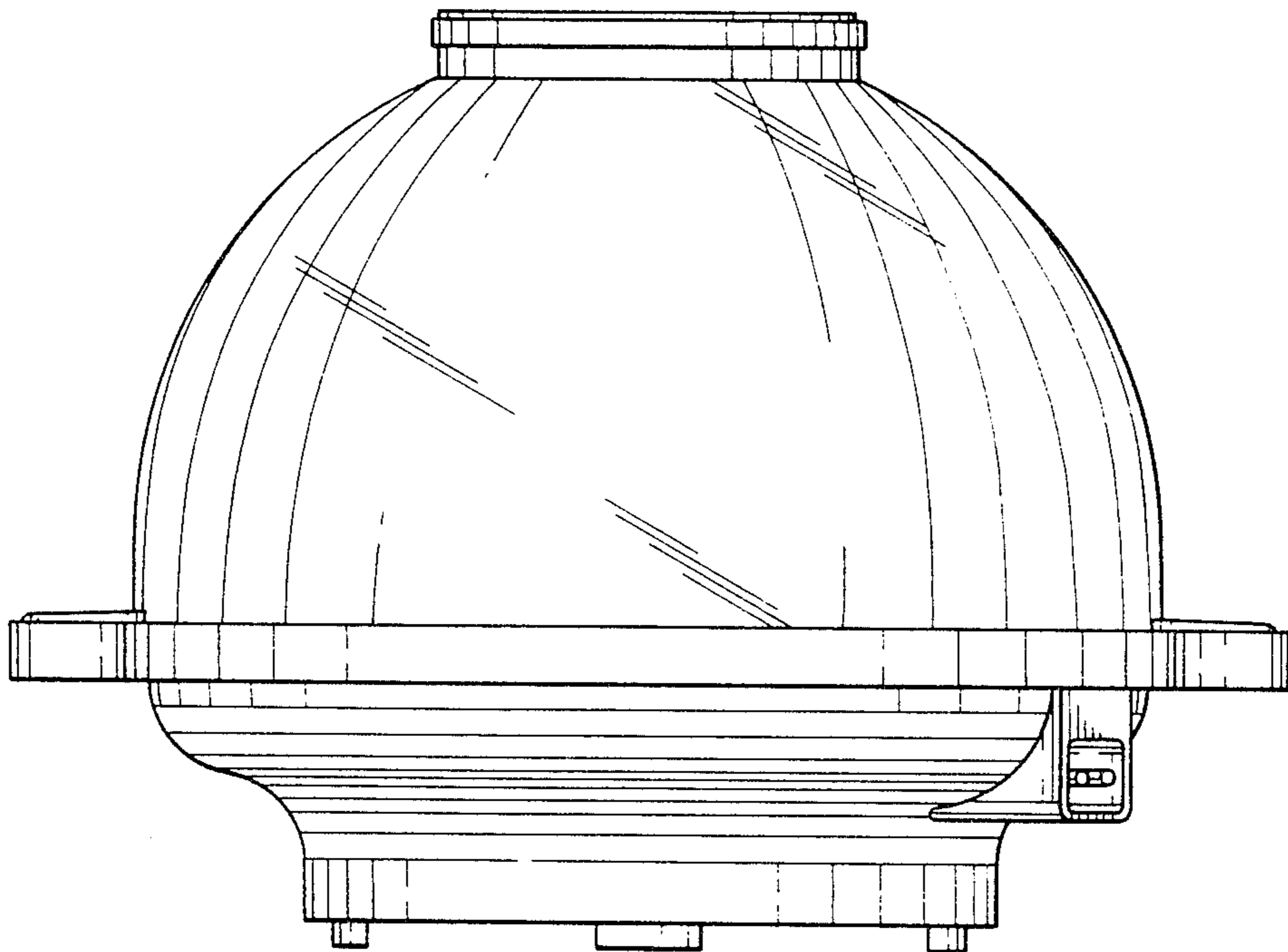

FIG. 6

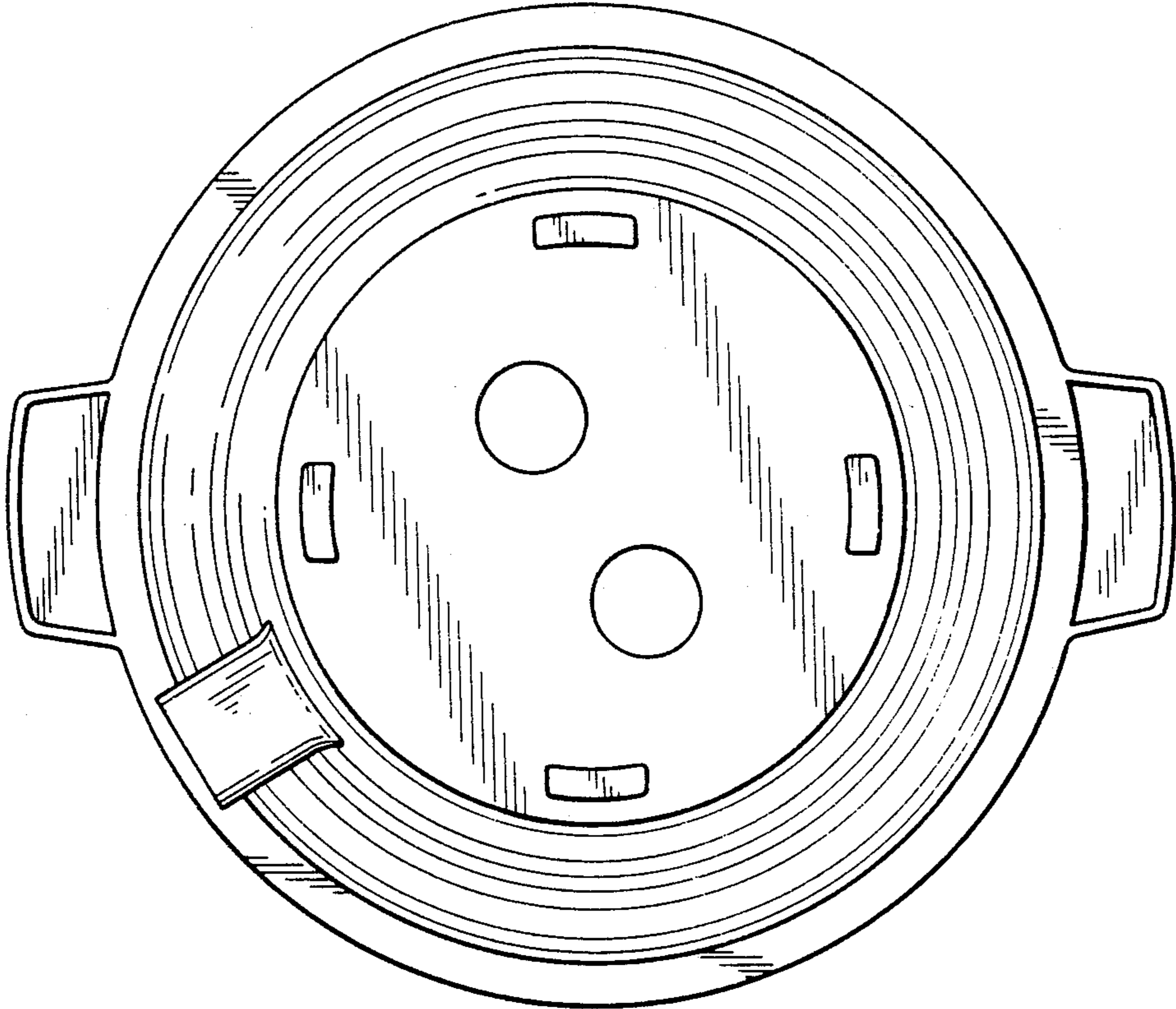

FIG. 7