

[54] **FOOD CONTAINER WITH PRESS-IN LID**

[75] **Inventor: Arthur R. Carlson, East Malvern, Australia**

[73] **Assignee: Brian Davis and Company Proprietary Limited, Scoresby, Australia**

[\*] **Notice: The portion of the term of this patent subsequent to Nov. 30, 1996 has been disclaimed.**

[\*\*] **Term: 14 Years**

[21] **Appl. No.: 342,728**

[22] **Filed: Jan. 25, 1982**

[52] **U.S. Cl. .... D7/16; D7/79**

[58] **Field of Search ..... D9/425, 428, 431, 435, D9/426; D34/40-46; 229/2.5; D7/16.17, 76, 79**

[56] **References Cited**

**U.S. PATENT DOCUMENTS**

D. 257,107 9/1980 Dagnen et al. .... D9/424  
2,780,385 2/1957 Tupper ..... D9/431  
3,448,880 6/1969 Smith et al. .... D9/425

*Primary Examiner—George P. Word  
Attorney, Agent, or Firm—Walter H. Schneider*

[57] **CLAIM**

The ornamental design for a food container with press-in lid, as shown and described.

**DESCRIPTION**

FIG. 1 is a side elevational view of a food container with press-in lid showing my new design;  
FIG. 2 is an end elevational view thereof;  
FIG. 3 is a bottom plan view thereof;  
FIG. 4 is a top plan view thereof;  
FIG. 5 is a reduced scale exploded side elevational view thereof;  
FIG. 6 is a reduced scale exploded end elevational view thereof;  
FIG. 7 is an exploded perspective view thereof; and  
FIG. 8 is a top perspective view of FIG. 1.

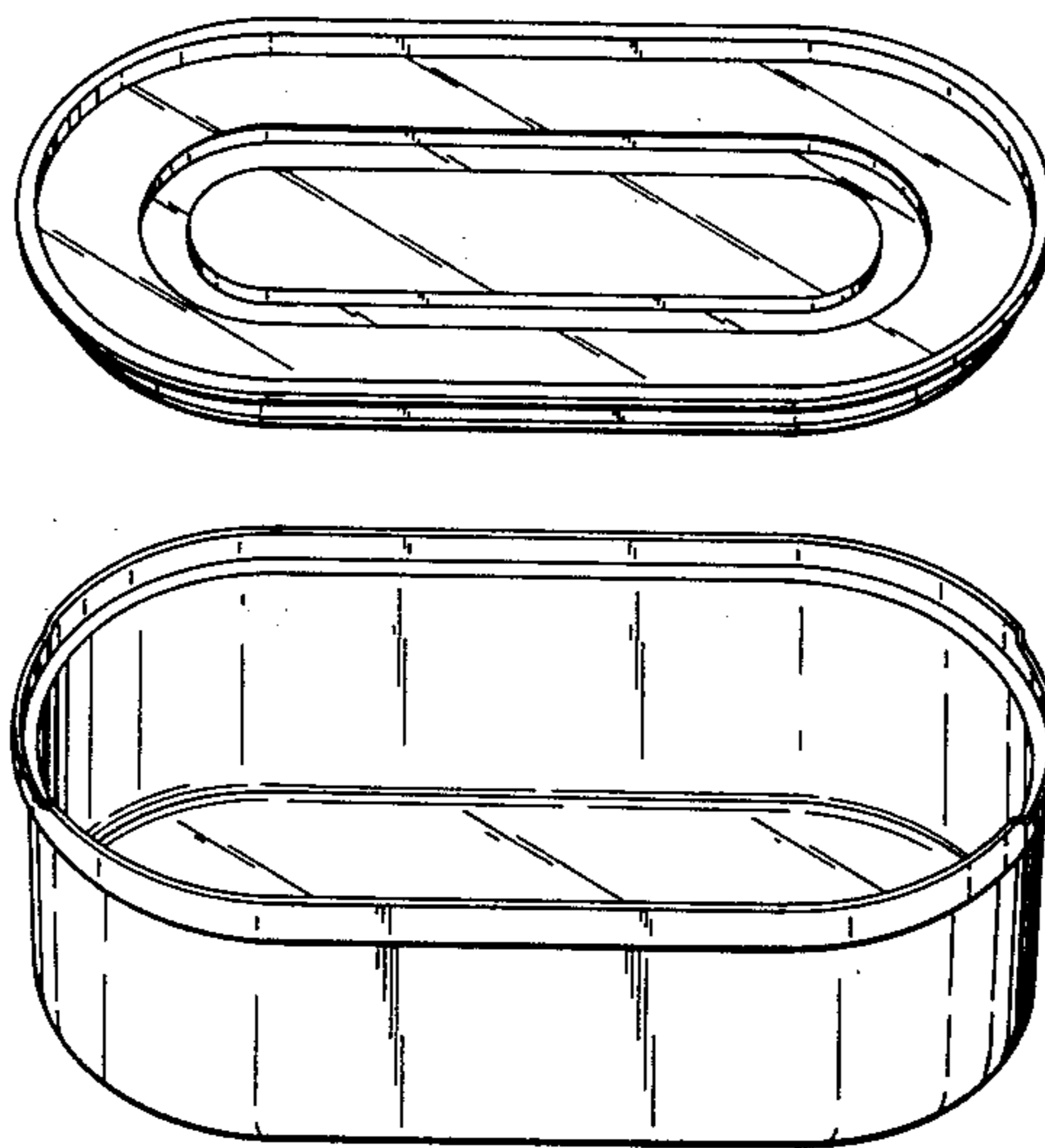

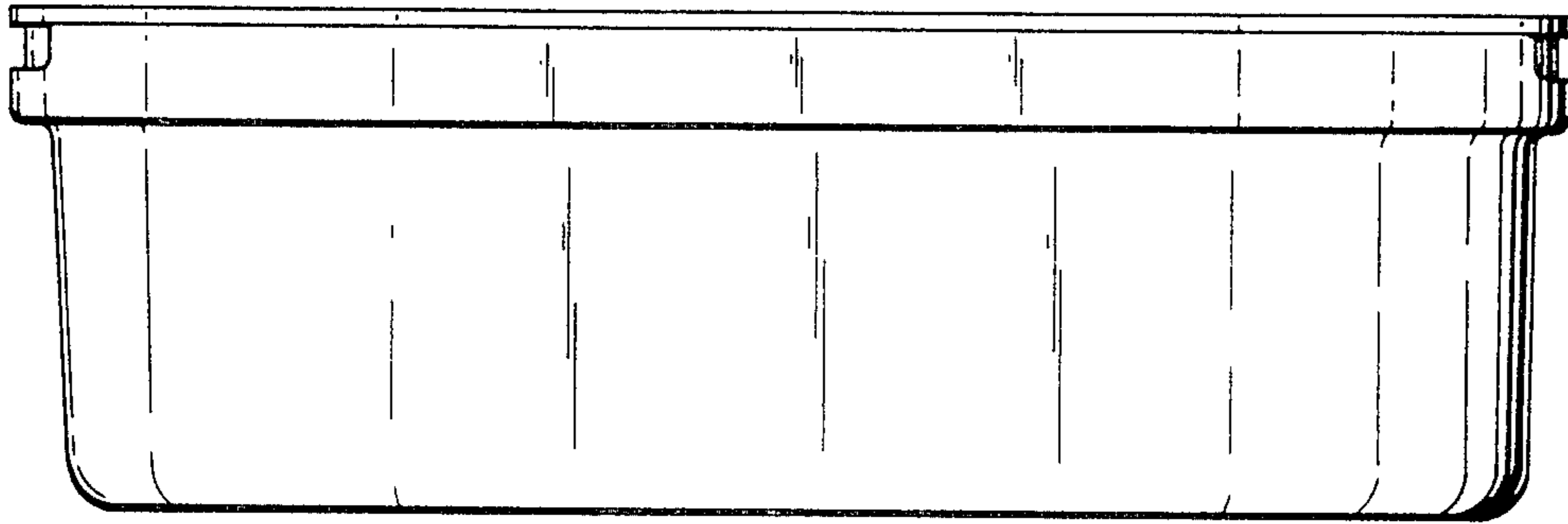

FIG. 1

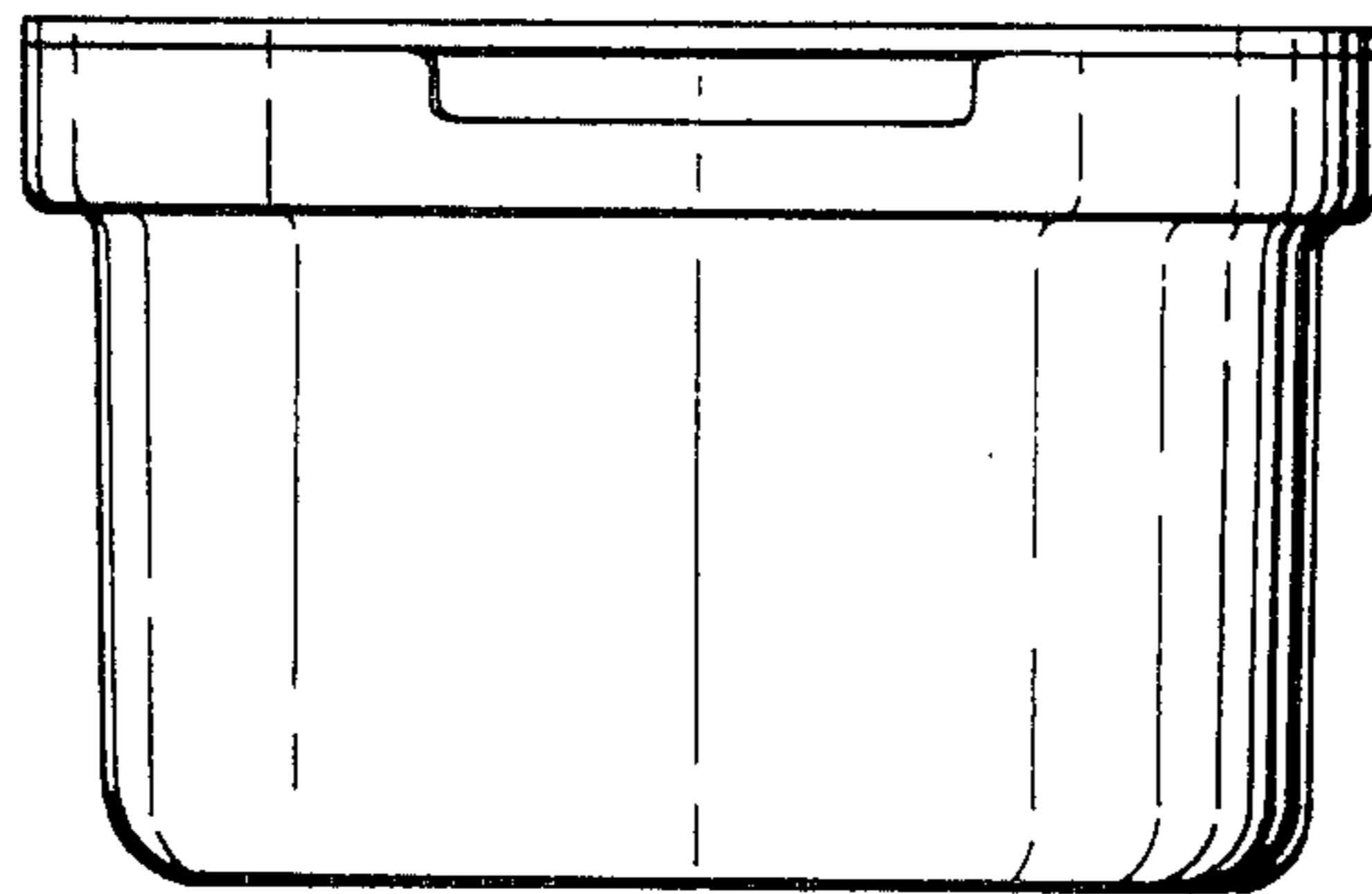

FIG. 2

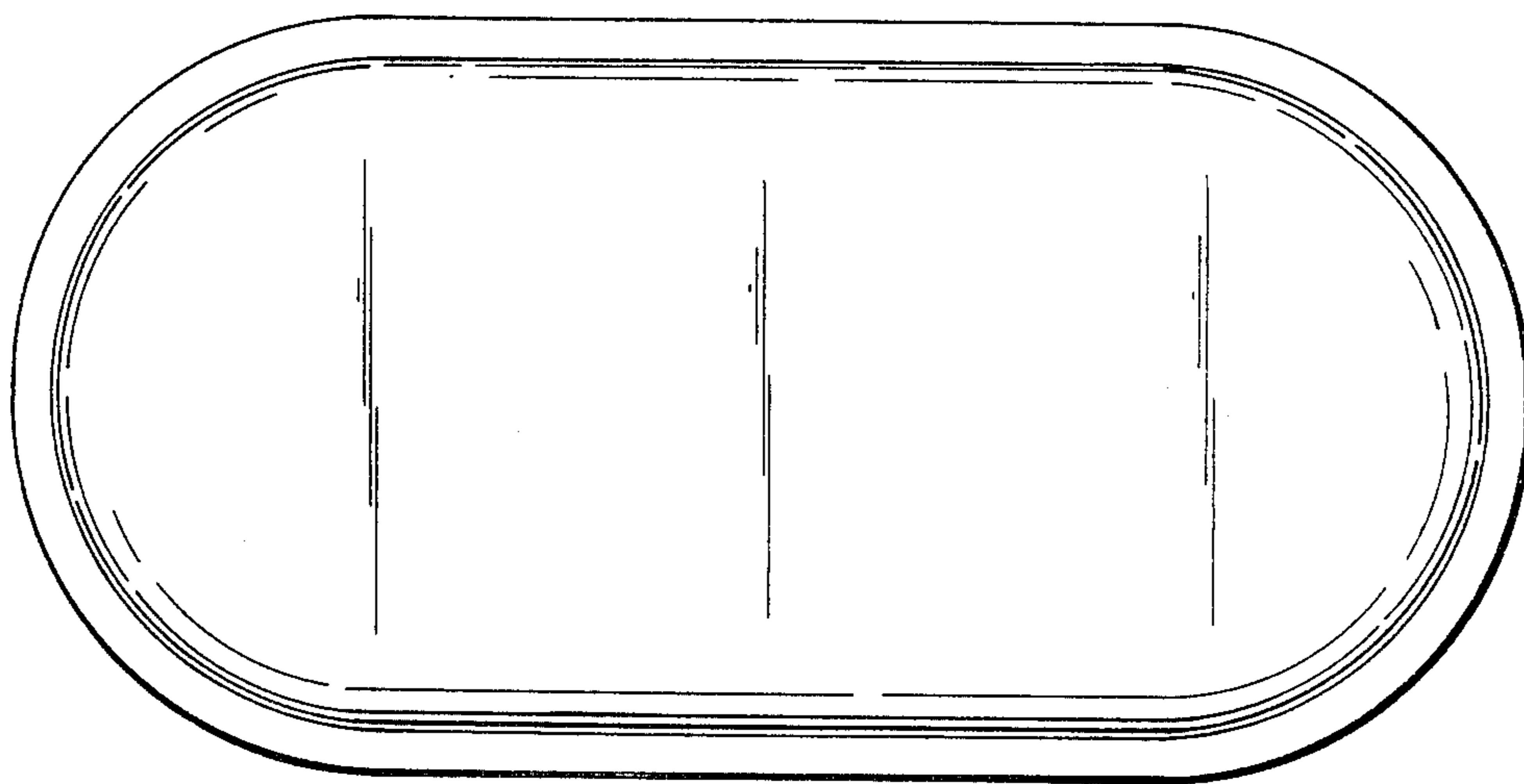

FIG. 3

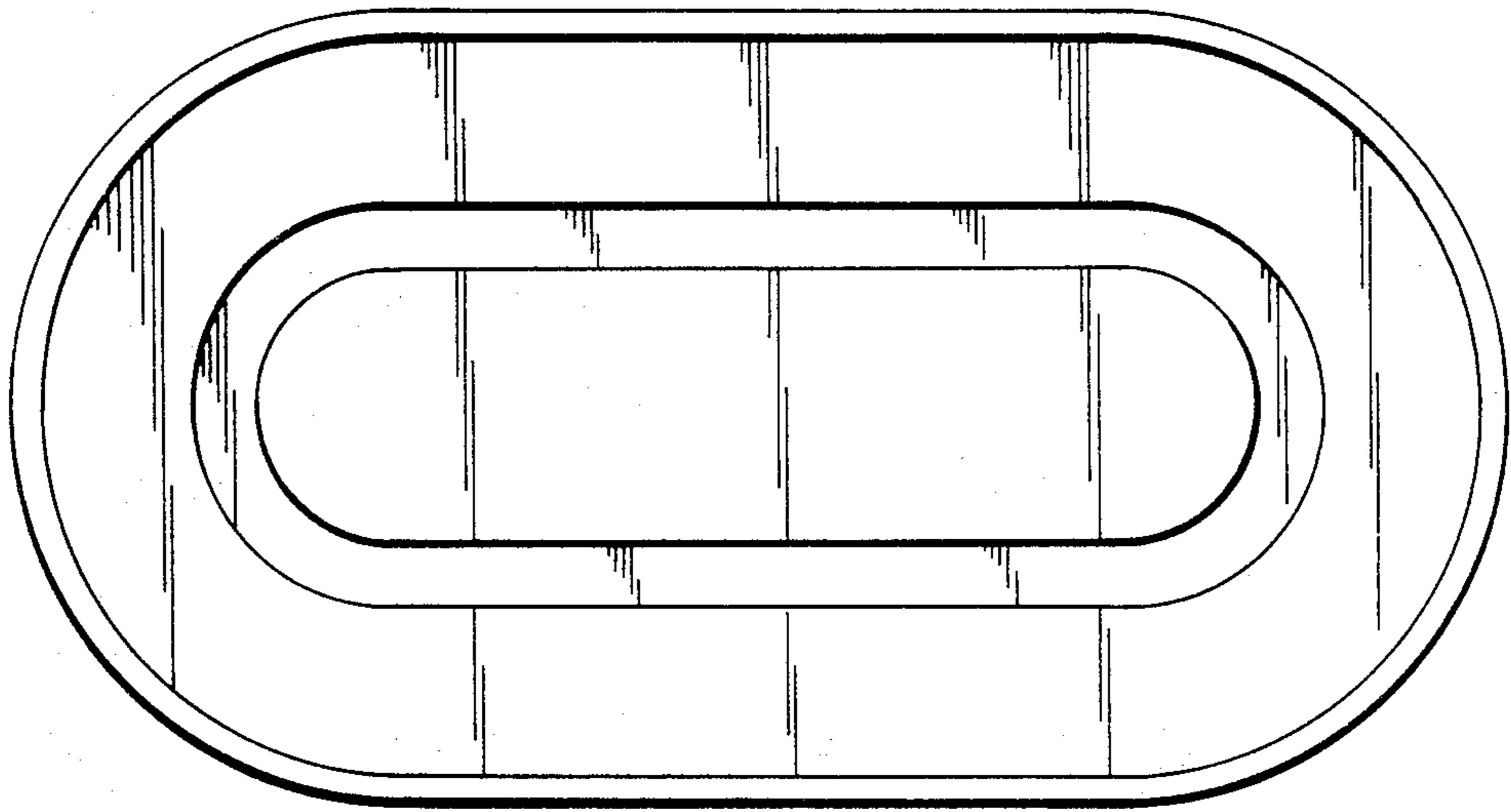

FIG. 4

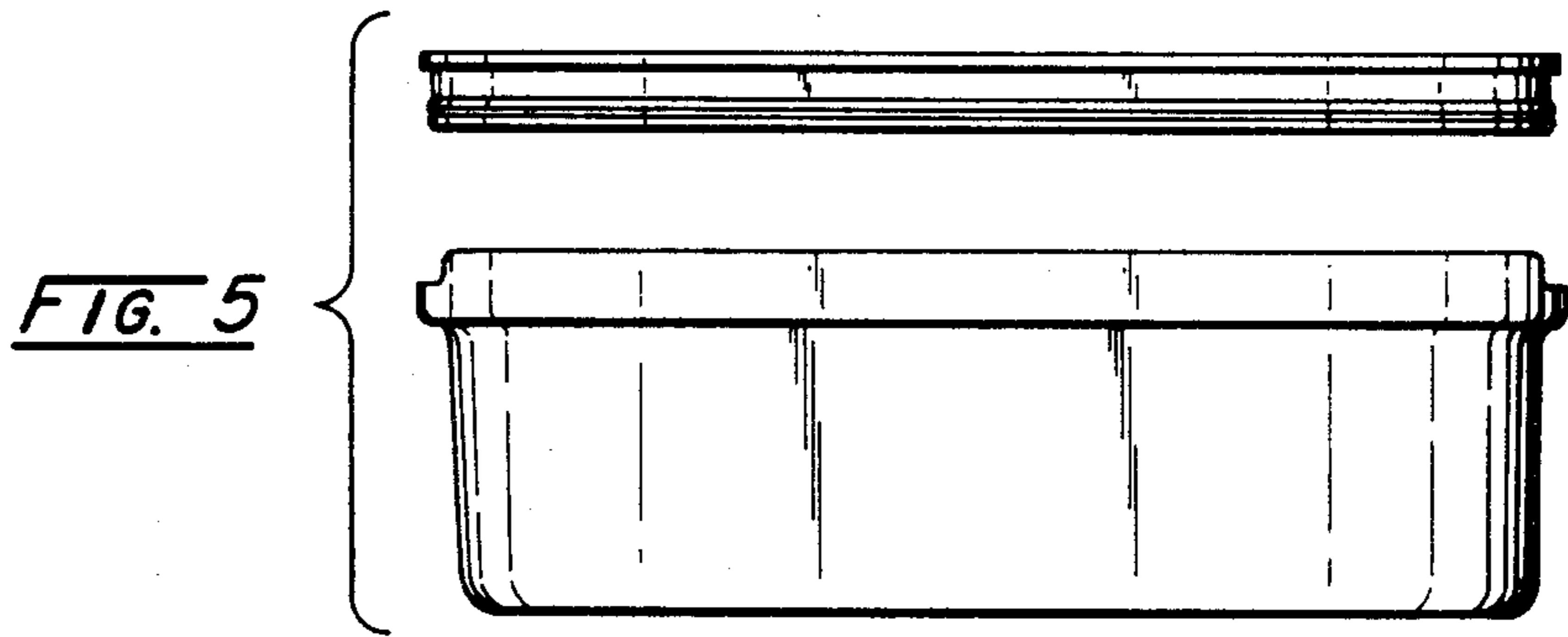

FIG. 5

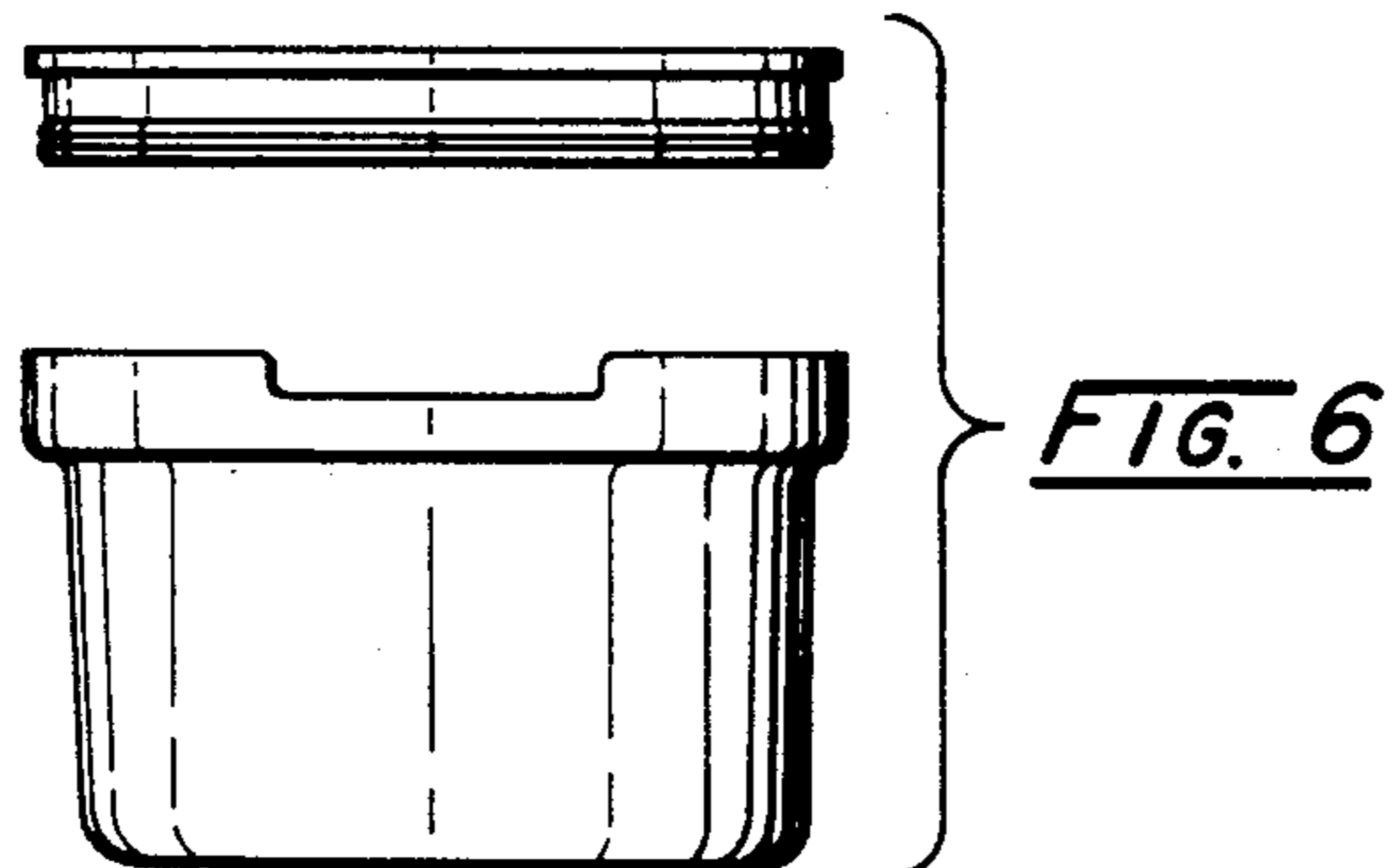

FIG. 6

