

[54] NOTE HOLDER STAND FOR CALENDARS AND DOCUMENTS

[76] Inventor: Andrew S. Lehman, 960 Bellmore Ave., North Bellmore, N.Y. 11710

[**] Term: 14 Years

[21] Appl. No.: 430,261

[22] Filed: Sep. 29, 1982

[52] U.S. Cl. D19/21

[58] Field of Search D19/21, 20, 65, 75; D14/59; 40/120, 11 R; D20/10, 15, 43, 99

[56] References Cited

U.S. PATENT DOCUMENTS

D. 159,576	8/1950	Bamford	D19/65
D. 172,756	8/1954	Montanye	D19/20
D. 215,054	8/1969	Swertz	D14/59
D. 221,491	8/1971	Finkel	D19/20
D. 256,258	8/1980	Varrin	D19/65 X
3,149,816	9/1964	Nichols	40/120
3,548,523	12/1970	Laws	40/11 R

Primary Examiner—Bernard Ansher
Assistant Examiner—Theodore M. Shooman
Attorney, Agent, or Firm—Bauer & Amer

[57] CLAIM

The ornamental design for a note holder stand for calendars and documents, as shown and described.

DESCRIPTION

FIG. 1 is a right end elevational view of a note holder stand for calendars and documents showing my new design;

FIG. 2 is a top plan view thereof as seen from line 2—2; FIG. 3 is a front elevational view thereof as seen from line 3—3;

FIG. 4 is a rear elevational view thereof as seen from line 4—4;

FIG. 5 is a bottom plan view thereof as seen from line 5—5;

FIG. 6 is a section taken along line 6—6 of FIG. 4;

FIG. 7 is an enlarged fragmental section taken along line 7—7 of FIG. 4; and

FIG. 8 is a top front perspective view thereof.

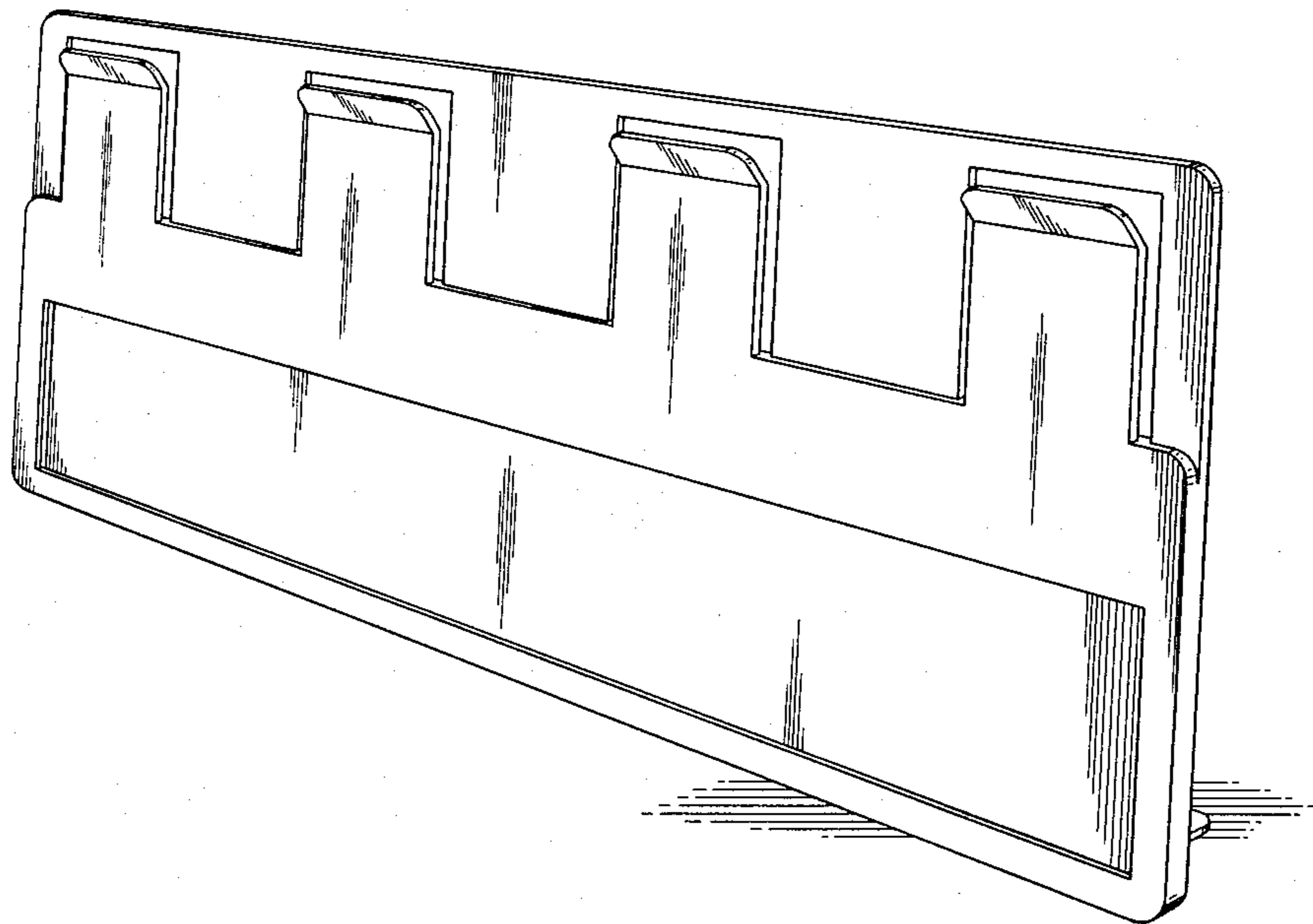

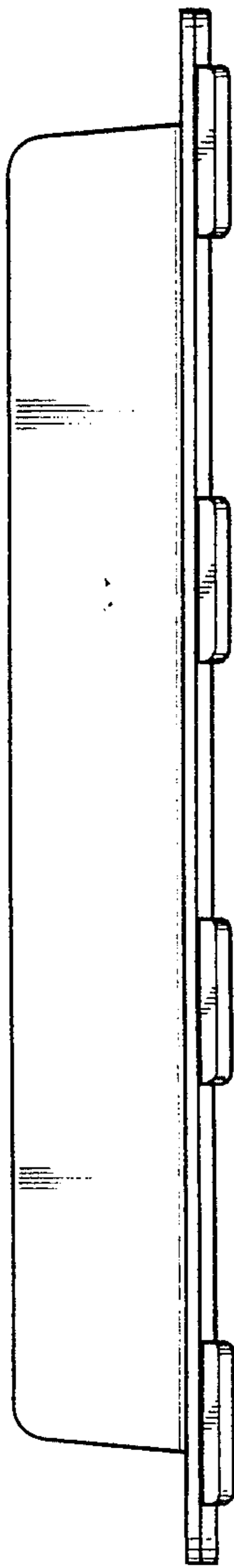

Fig.2

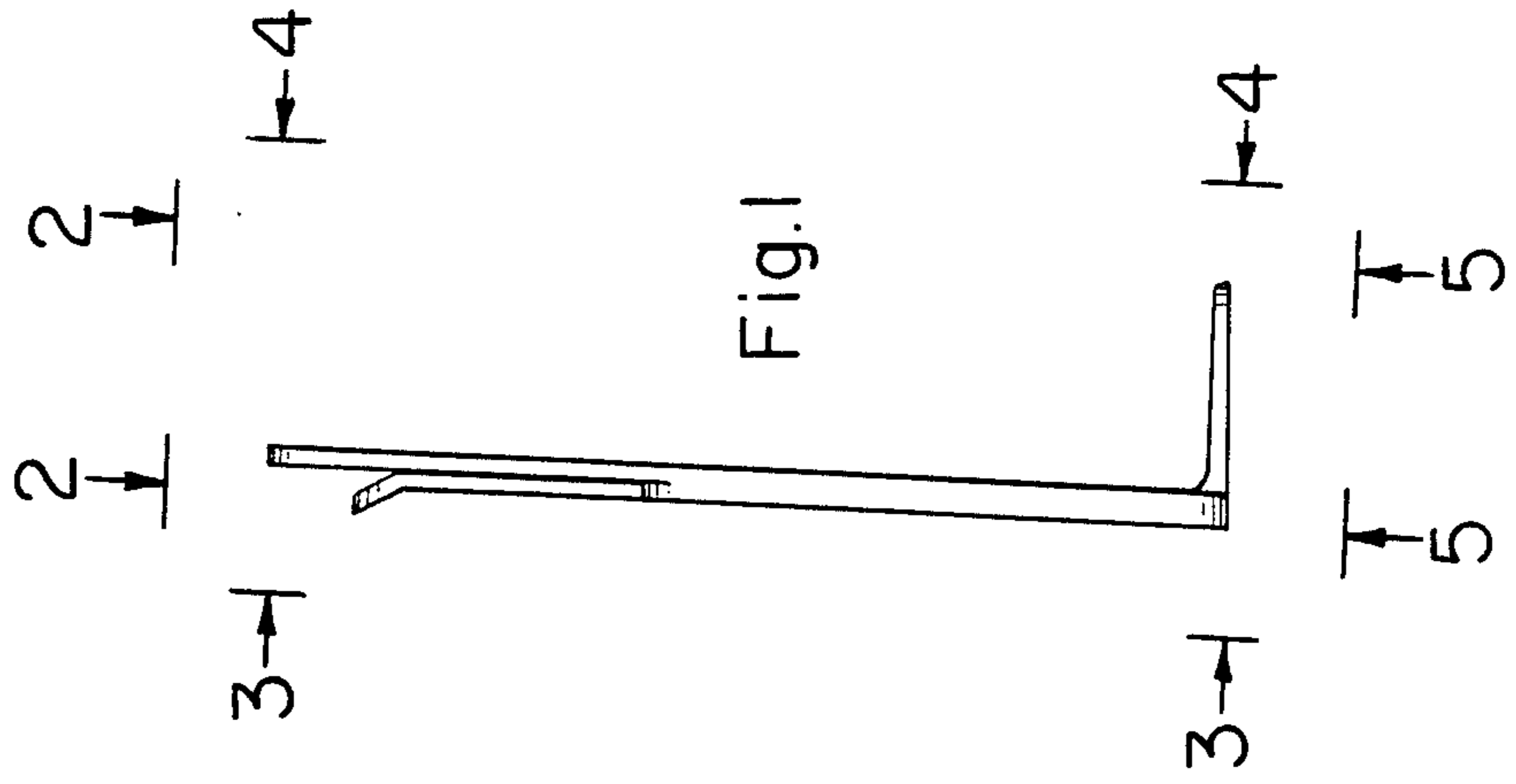

Fig.1

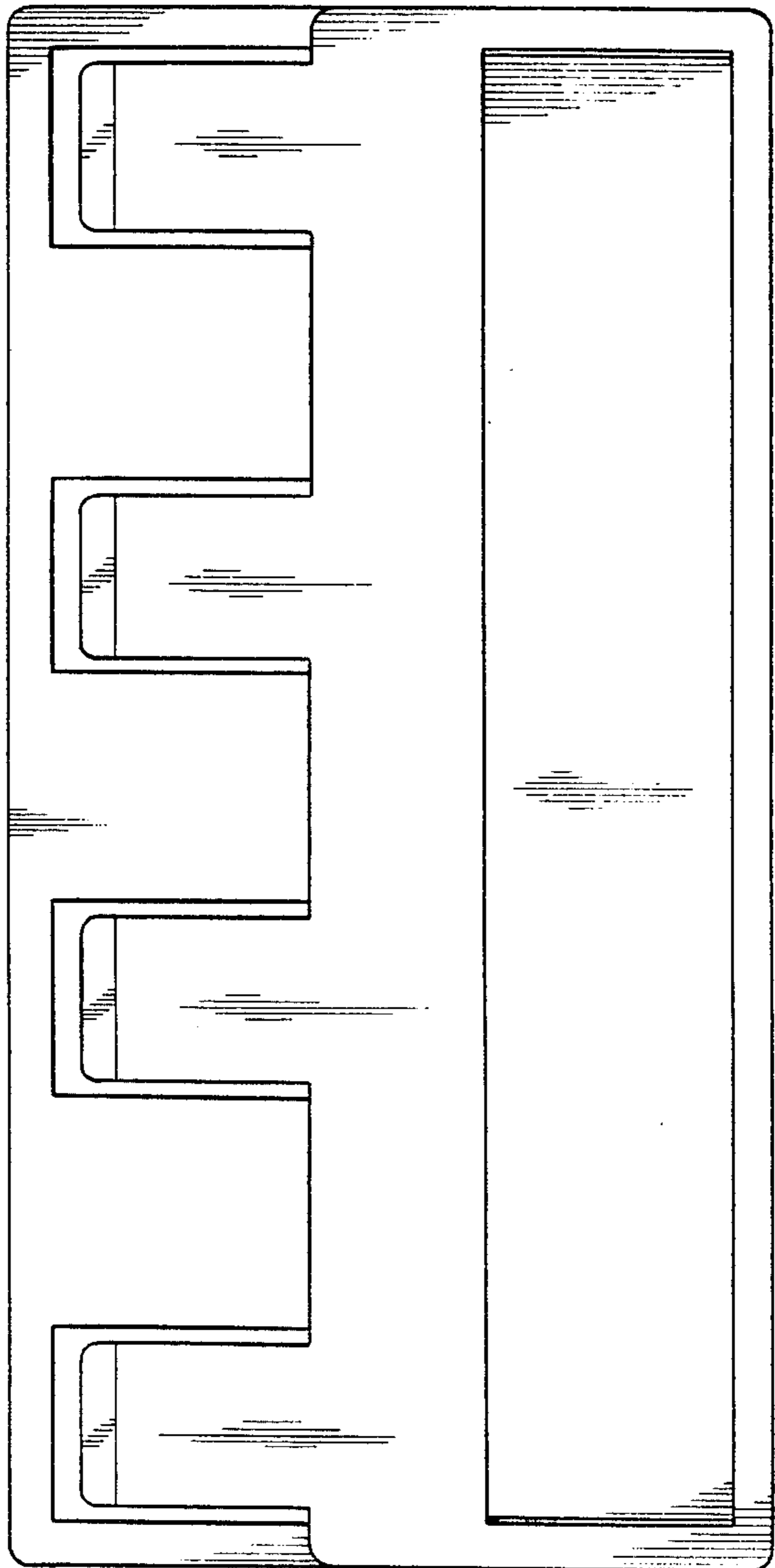

Fig.3

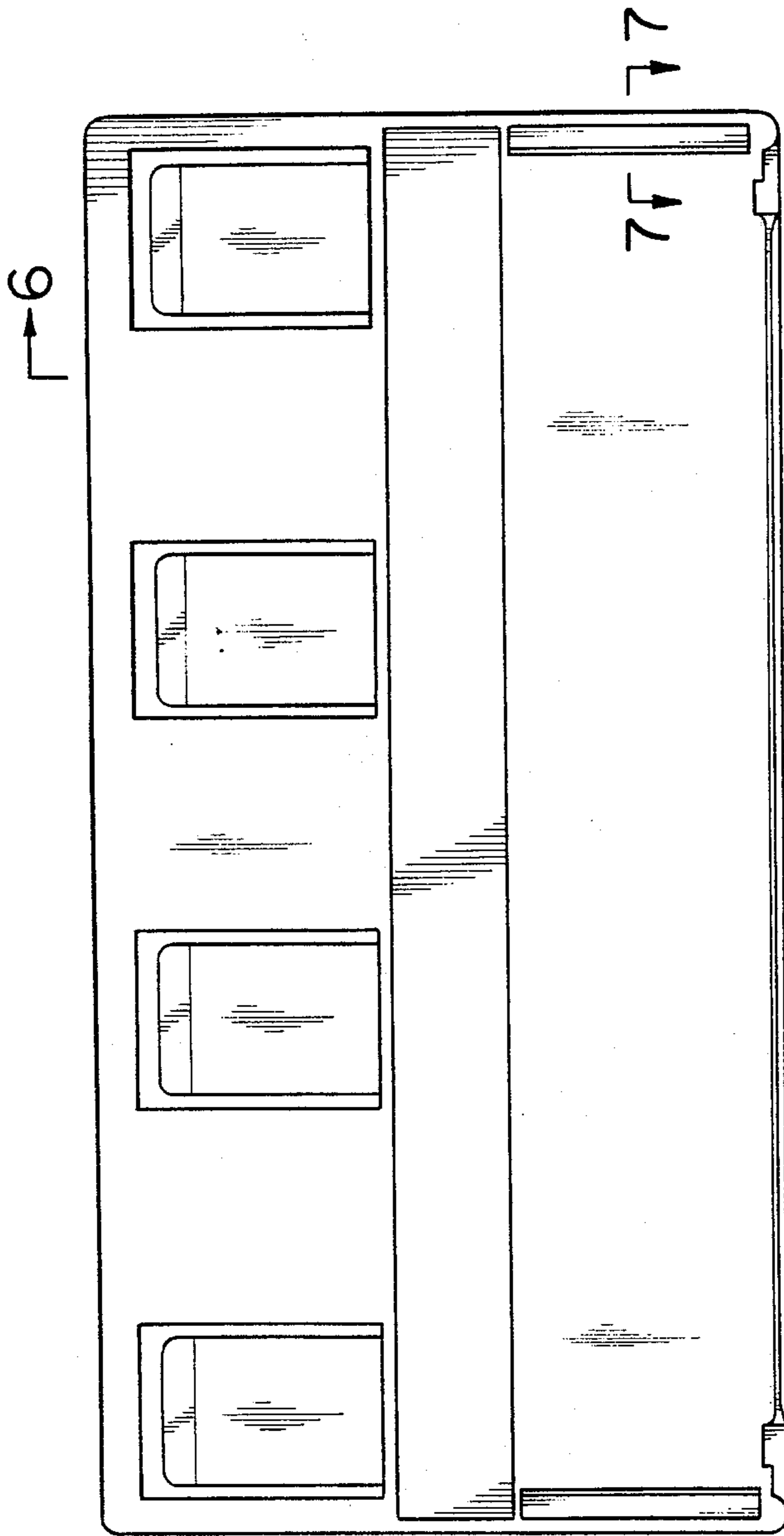

Fig. 4

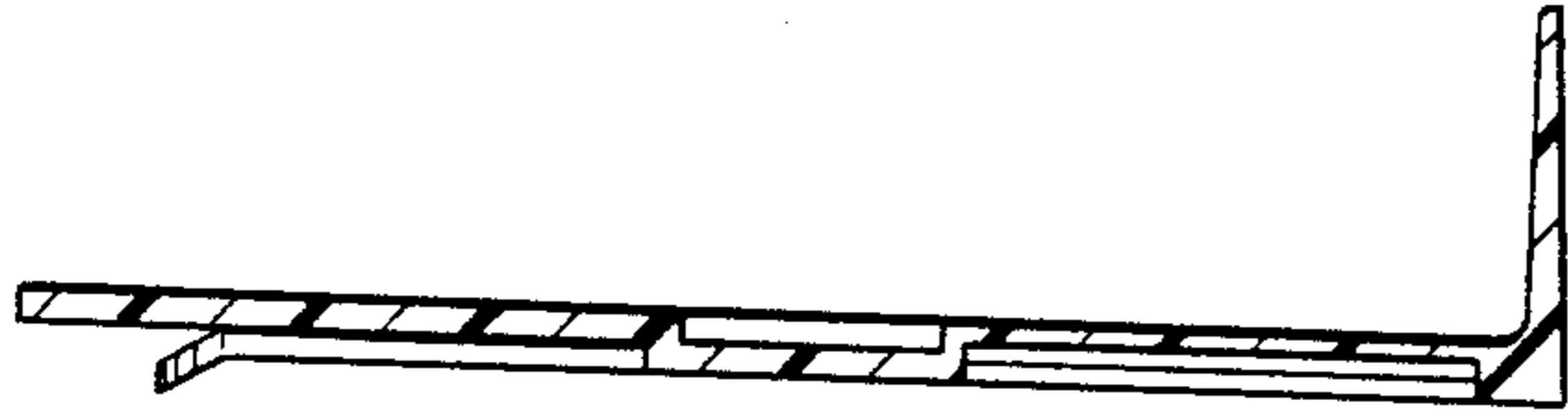

Fig. 6

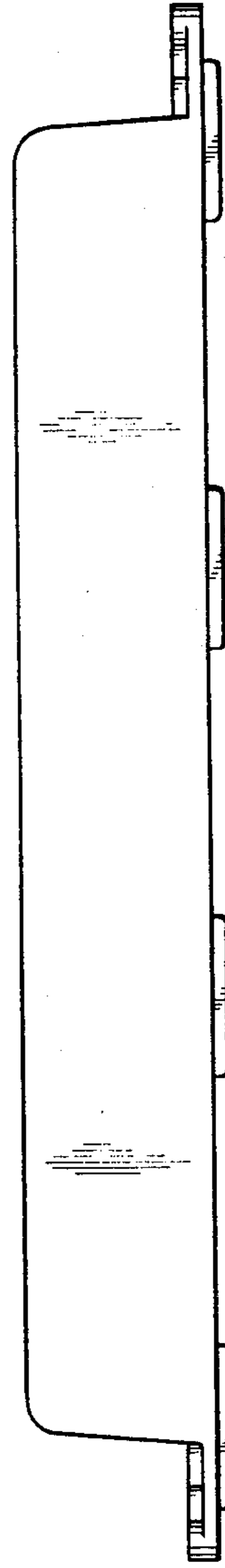

Fig. 5



Fig. 7

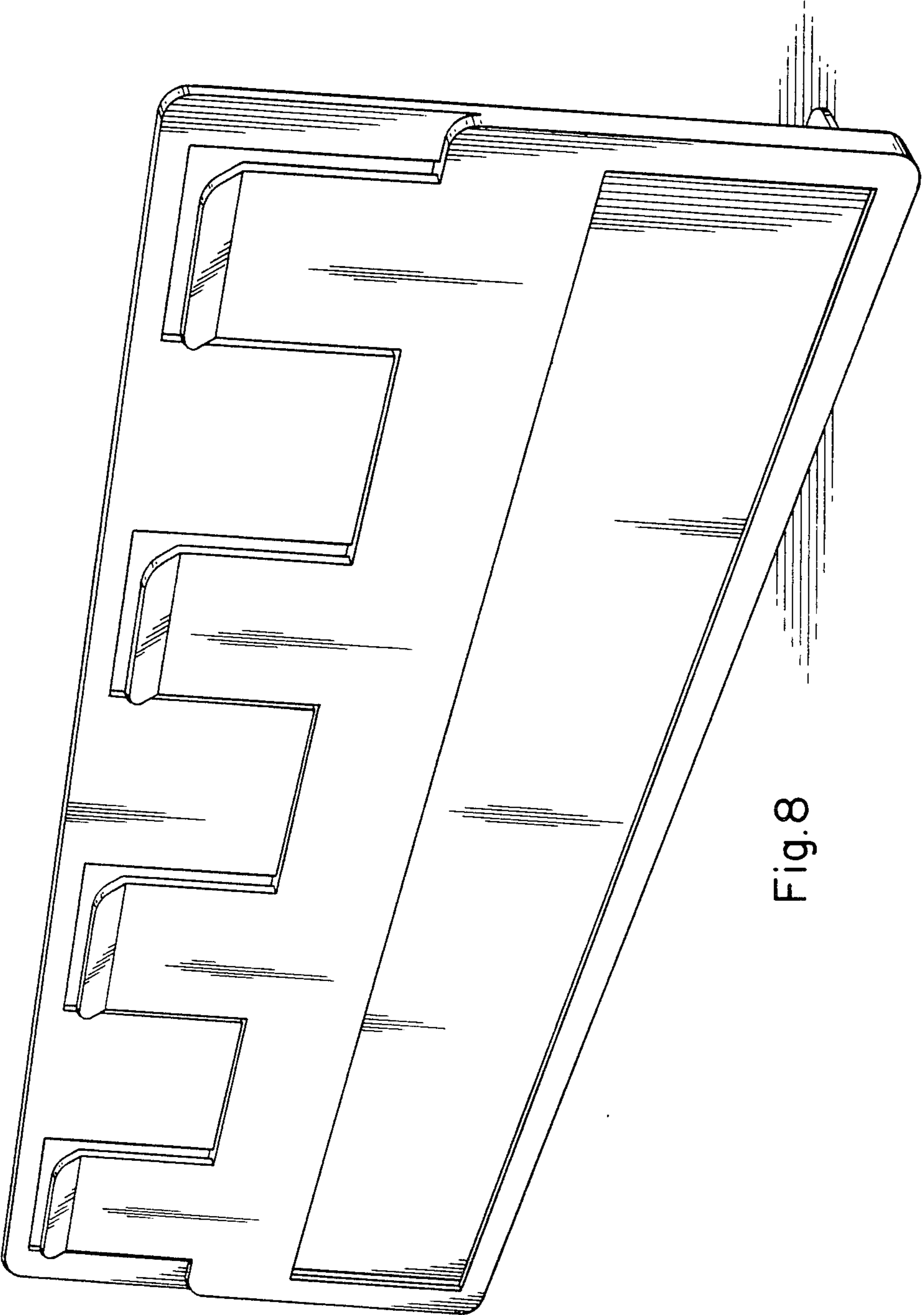

Fig. 8