

[54] FOOD BOWL

[76] Inventor: Steven J. Rossin, 1701 W. Robb Ave., Lima, Ohio 45805

[**] Term: 14 Years

[21] Appl. No.: 386,775

[22] Filed: Jun. 10, 1982

[52] U.S. Cl. D7/23; D7/28; D11/149; D11/152; D34/39

[58] Field of Search D7/23, 22, 29-36, D7/28, 1, 3, 78, 98, 301; D11/143, 144, 145, 148, 152, 153; D9/325; D34/39; 217/72, 5, 80, 91; 144/33, 147

[56] References Cited

U.S. PATENT DOCUMENTS

D. 90,039	5/1933	Wehrenberg	D7/301
115,088	5/1871	Niles	217/72
D. 151,079	9/1948	Sherry et al.	D7/98 X
D. 249,444	9/1979	Forsberg	D7/78
2,315,742	4/1943	Shipman	217/80 X

OTHER PUBLICATIONS

Jackson Vitrified China Co., Cat. #11, 5-27-1948, p. 20, Item #190—Hooped Ice Tub, center of page.

Figis Gifts, 1967 Cat., p. 42, "Bucket-o-Nuts", #122, Chestnut Finish, bucket at bottom.

Fine Wood Working, No. 31, Nov./Dec. 1981, p. 75, "Turning for Figure", Wood Grains on top left tray.

Primary Examiner—Winifred E. Herrmann

Attorney, Agent, or Firm—Jeffers, Irish & Hoffman

[57] CLAIM

The ornamental design for a food bowl, as shown and described.

DESCRIPTION

FIG. 1 is a top perspective view of a food bowl showing my new design;

FIG. 2 is a bottom perspective view thereof;

FIG. 3 is a top view;

FIG. 4 is a bottom view; and

FIG. 5 is a side elevational view thereof, it being understood that the other sides are similar except for the wood graining pattern thereon.

The characteristic feature of the design resides in the side wall comprising two hoops thereon with a space therebetween of equal height to the hoops, and to the bottom of the bowl having a concave surface as illustrated in FIGS. 2 and 4.

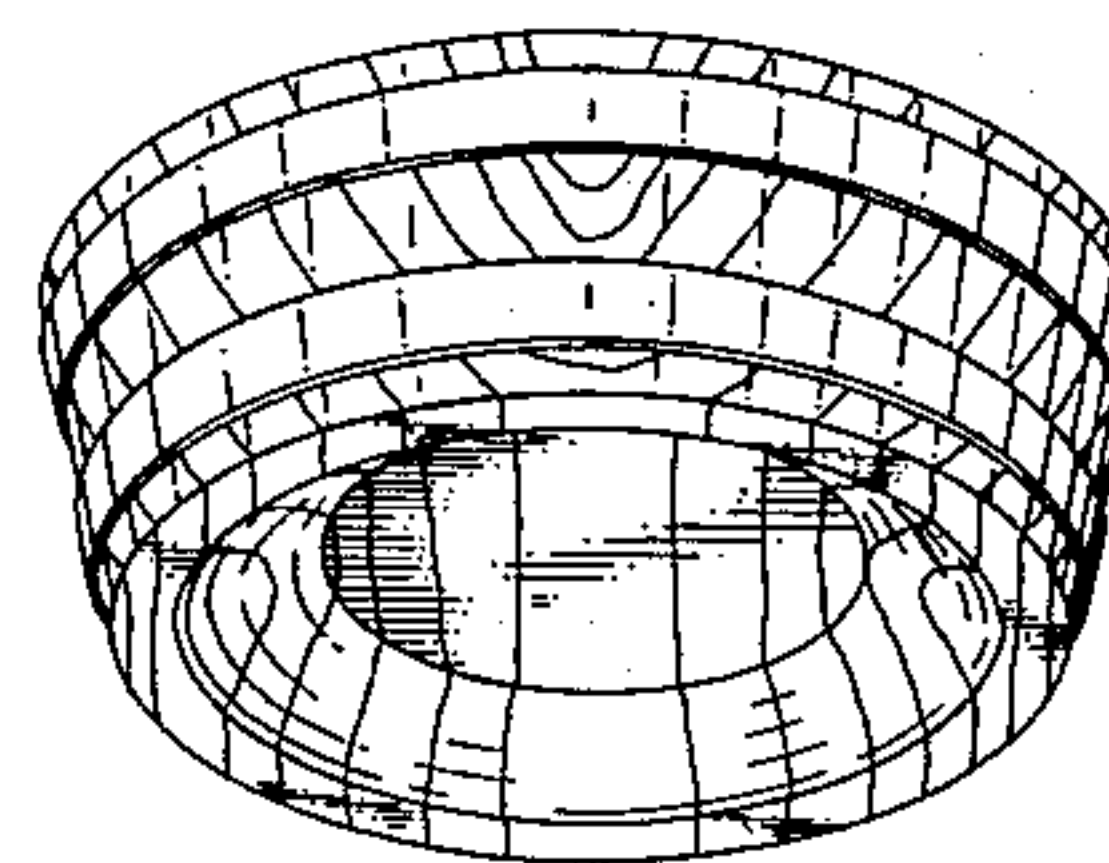
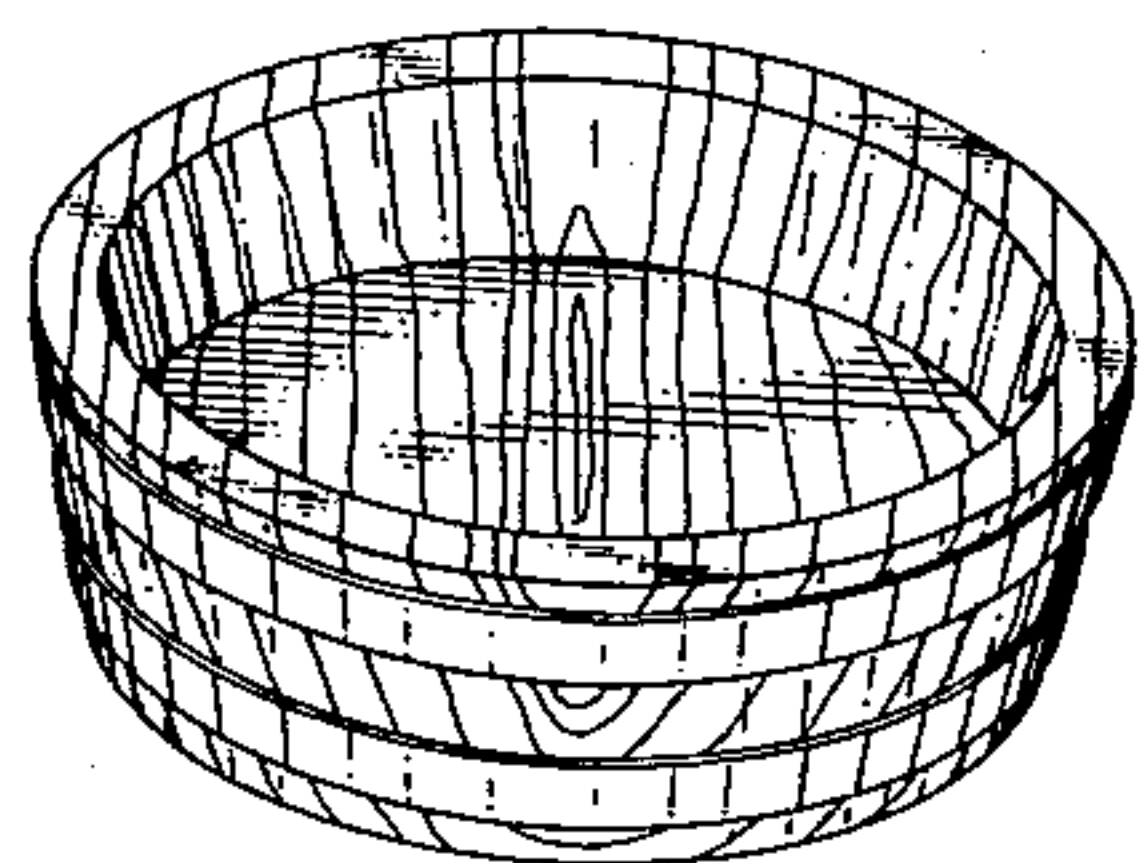

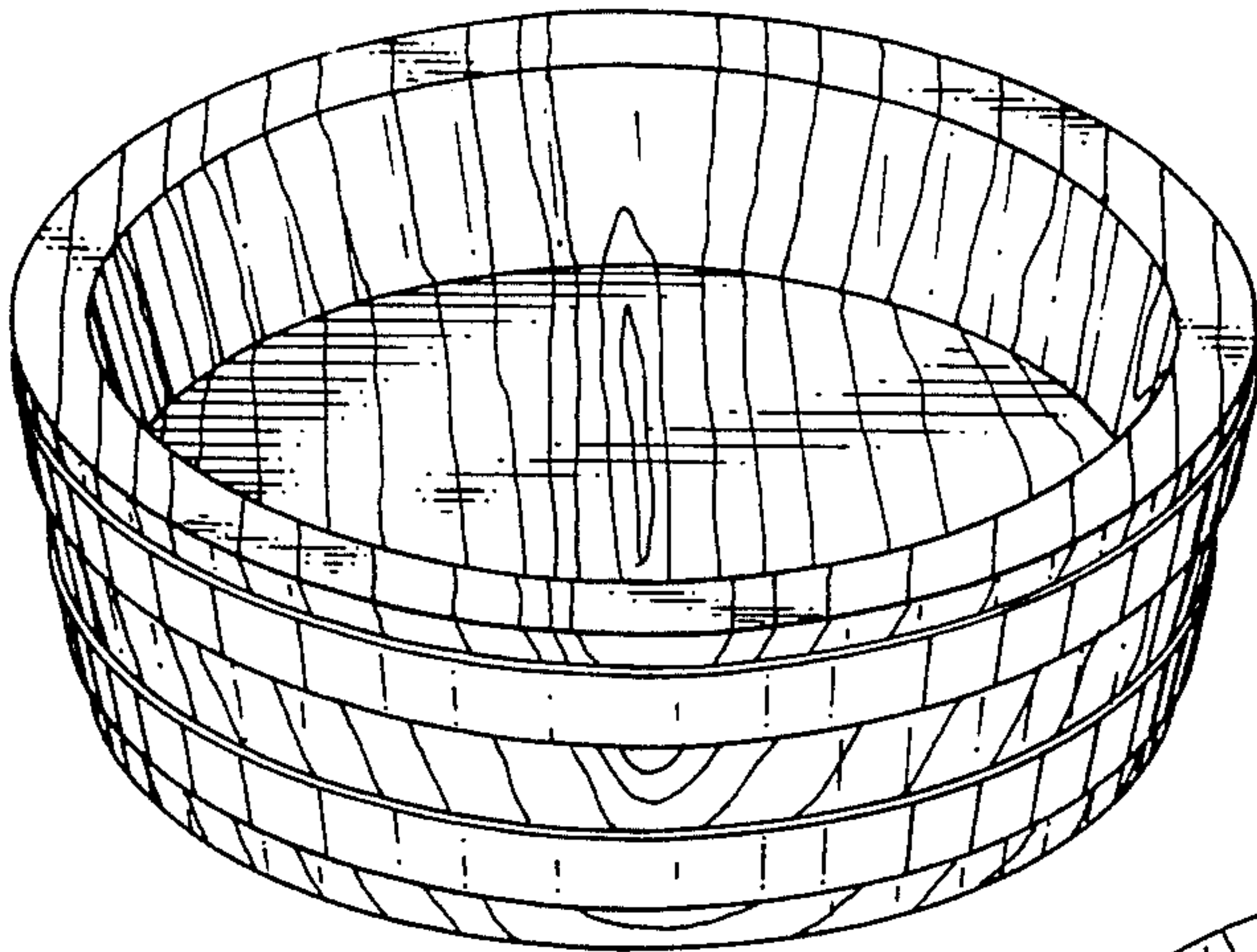

F I G 1

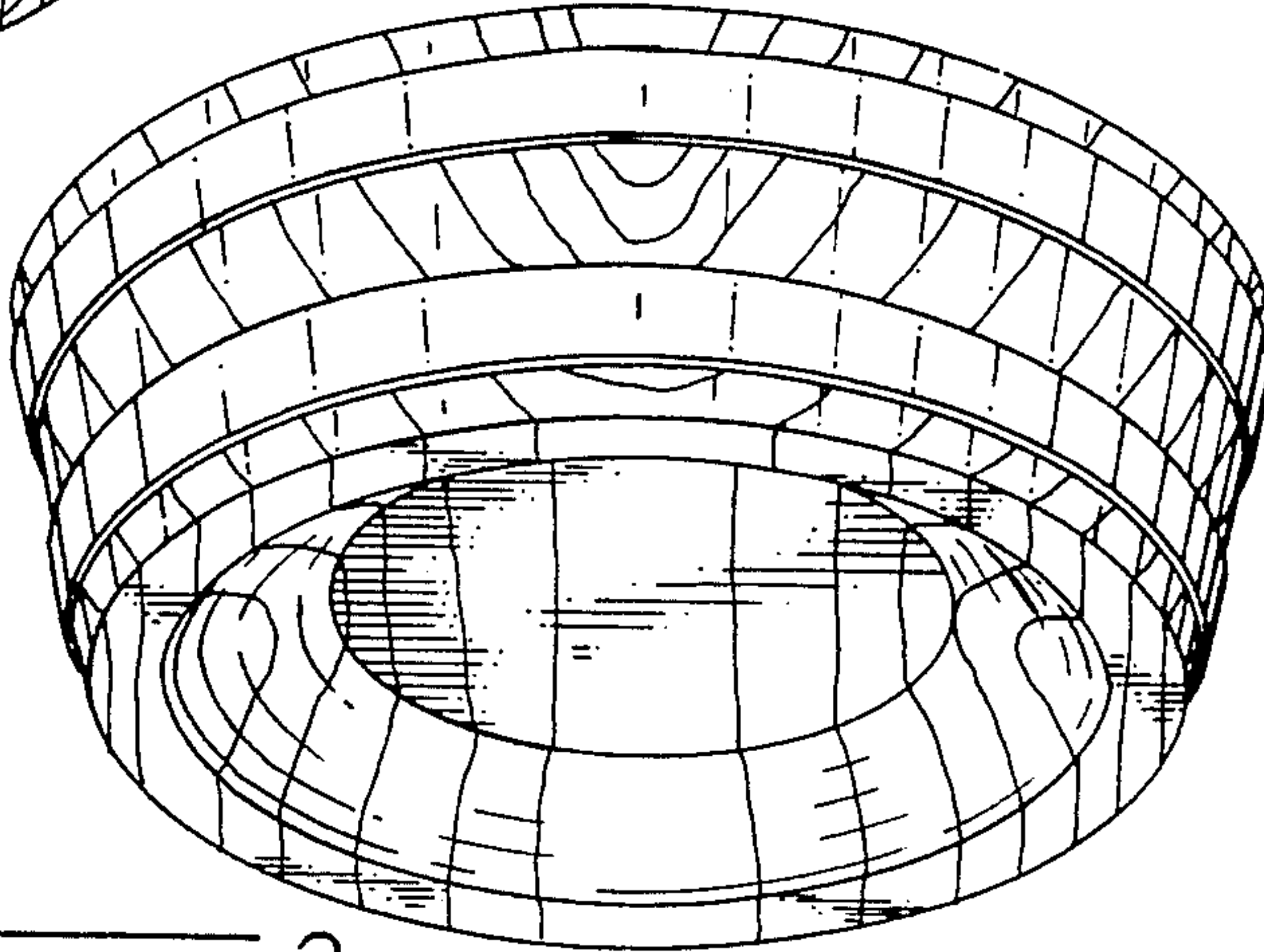

F I G 2

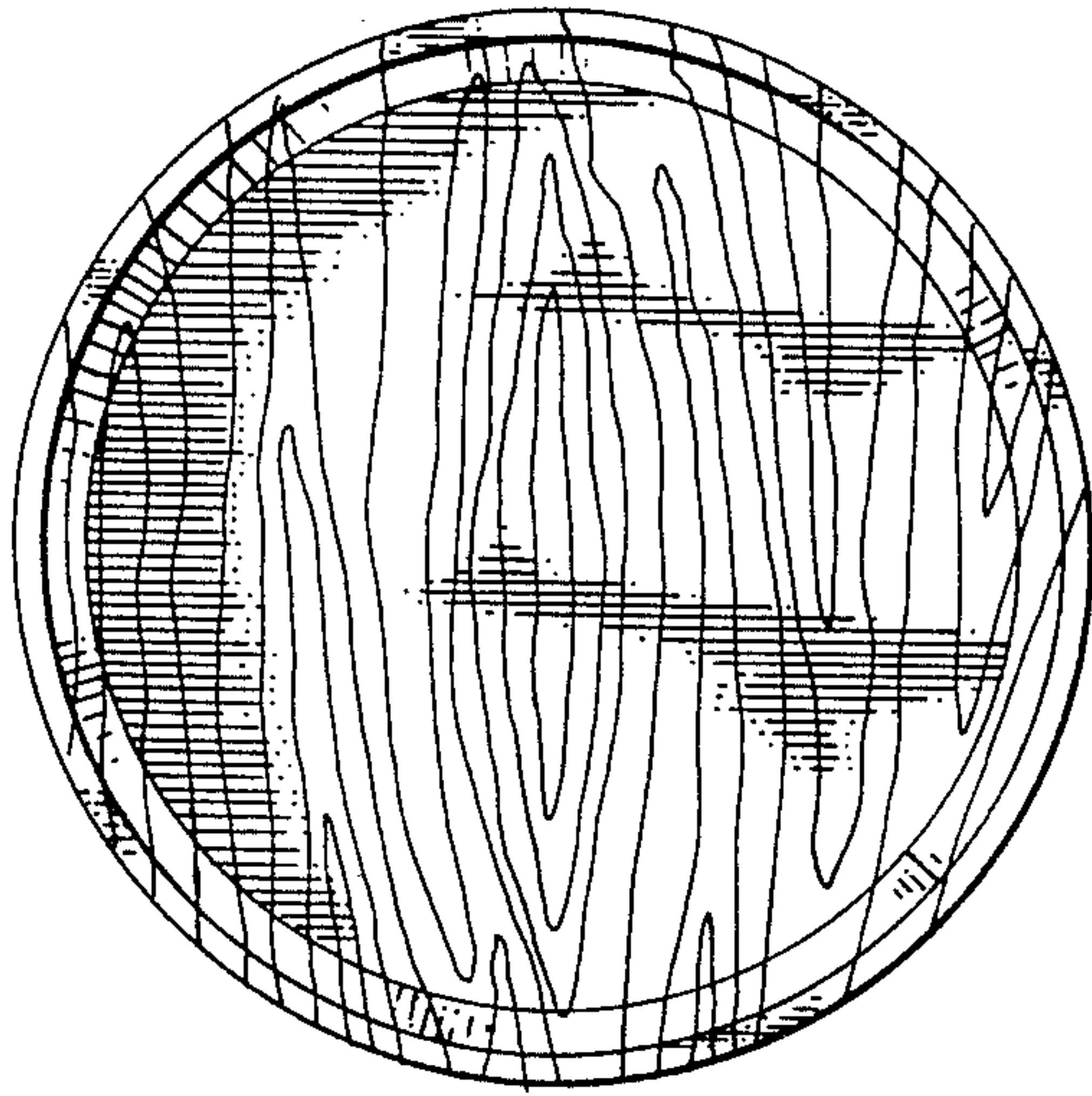

F I G 3

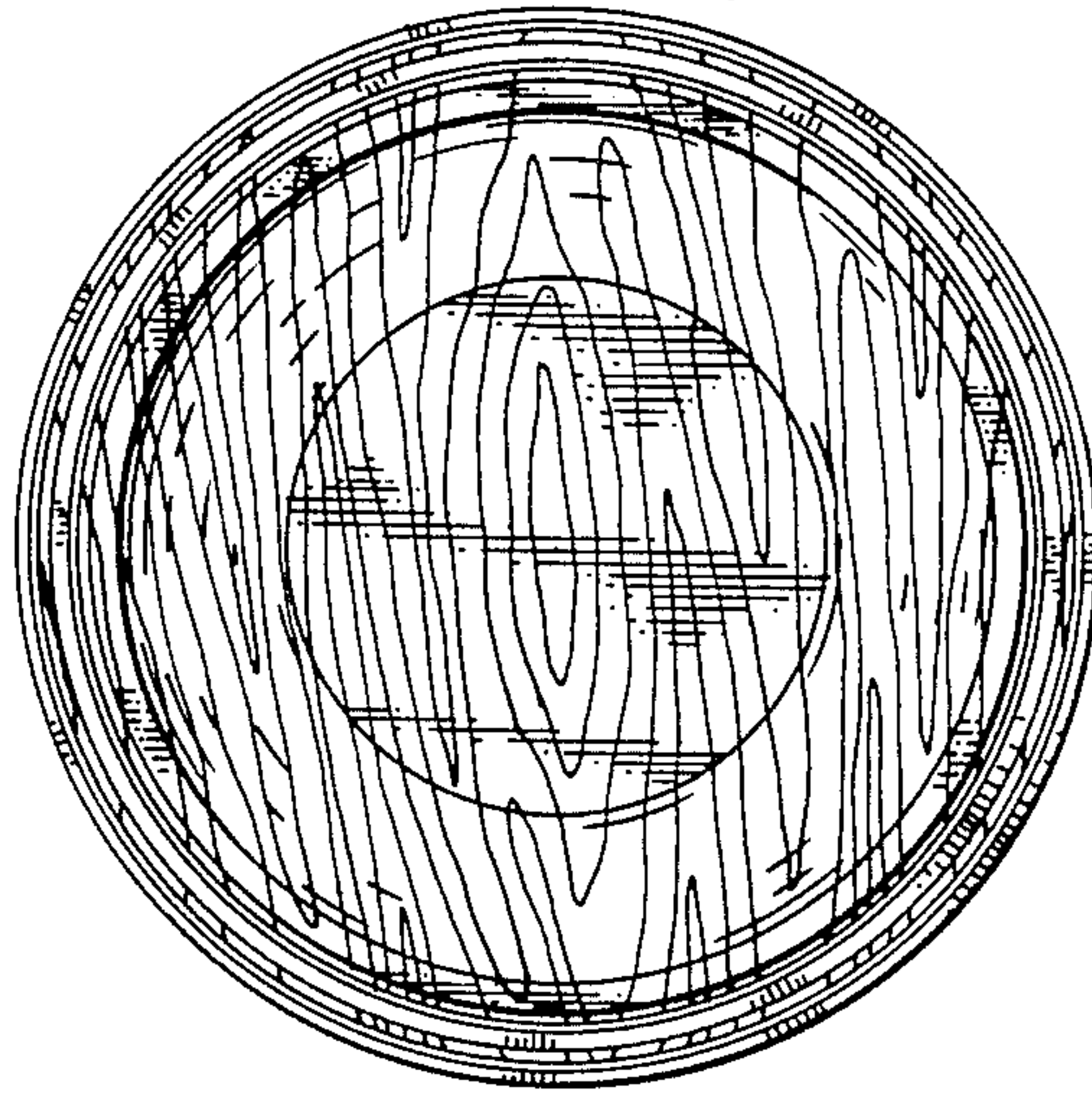

F I G 4

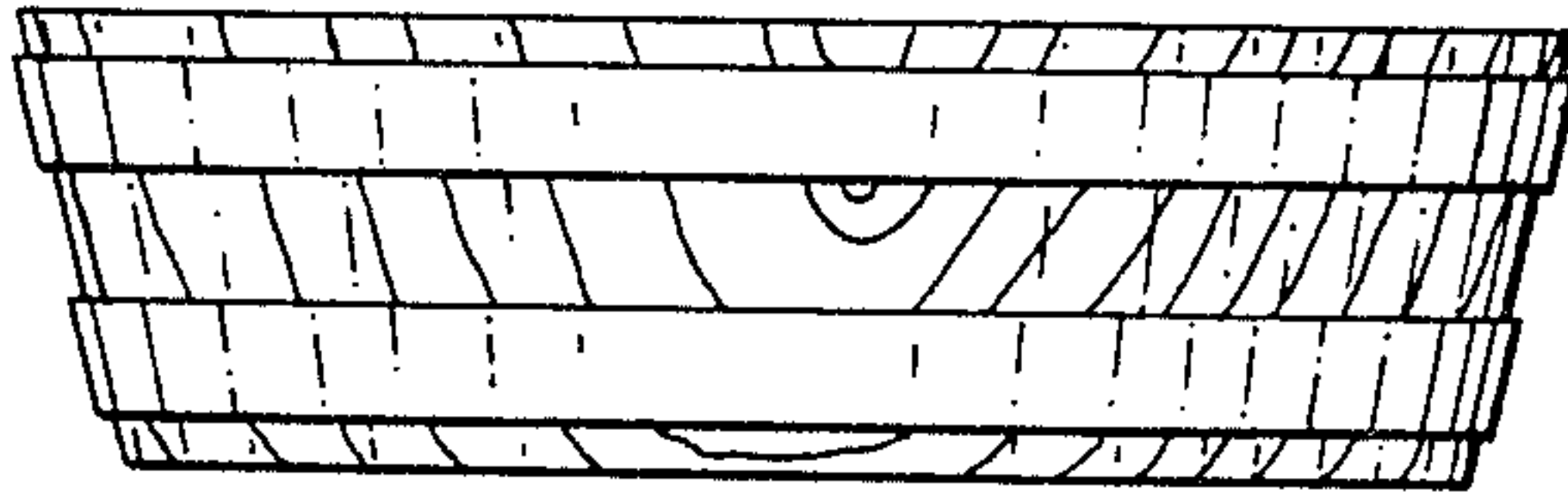

F I G 5