

[54] ROOM DIVIDER

[75] Inventors: Julian Vasquez; Samantha R. Anderson, both of Waco, Tex.

[73] Assignee: Heart of Texas Region Mental Health Mental Retardation Center, Waco, Tex.

[**] Term: 14 Years

[21] Appl. No.: 459,261

[22] Filed: Jan. 19, 1983

[52] U.S. Cl. D6/332

[58] Field of Search D6/332; 160/135, 351, 160/378, 377, 389; D2/80, 81, 208, 21

[56] References Cited

U.S. PATENT DOCUMENTS

D. 199,662	12/1964	Tillery	D2/208
D. 263,090	2/1982	Digiandomenico	D2/81
3,875,711	4/1975	Palmer	160/135
4,085,789	4/1978	Steiner et al.	160/135

4,121,645	10/1978	Behr	D6/332
4,134,439	6/1979	Scott	160/377

Primary Examiner—B. J. Bullock
Assistant Examiner—Suzanne N. Gitlin
Attorney, Agent, or Firm—Richards, Harris, Medlock & Andrews

[57] CLAIM

The ornamental design for a room divider, as shown and described.

DESCRIPTION

FIG. 1 is a perspective view of a room divider showing our new design;
FIG. 2 is a front elevational view thereof;
FIG. 3 is a side elevational view thereof;
FIG. 4 is a top plan view thereof;
FIG. 5 is a rear elevational view thereof;
FIG. 6 is a bottom plan view thereof.
The fabric weave which is partially shown is understood to repeat uniformly throughout the circumscribed area.

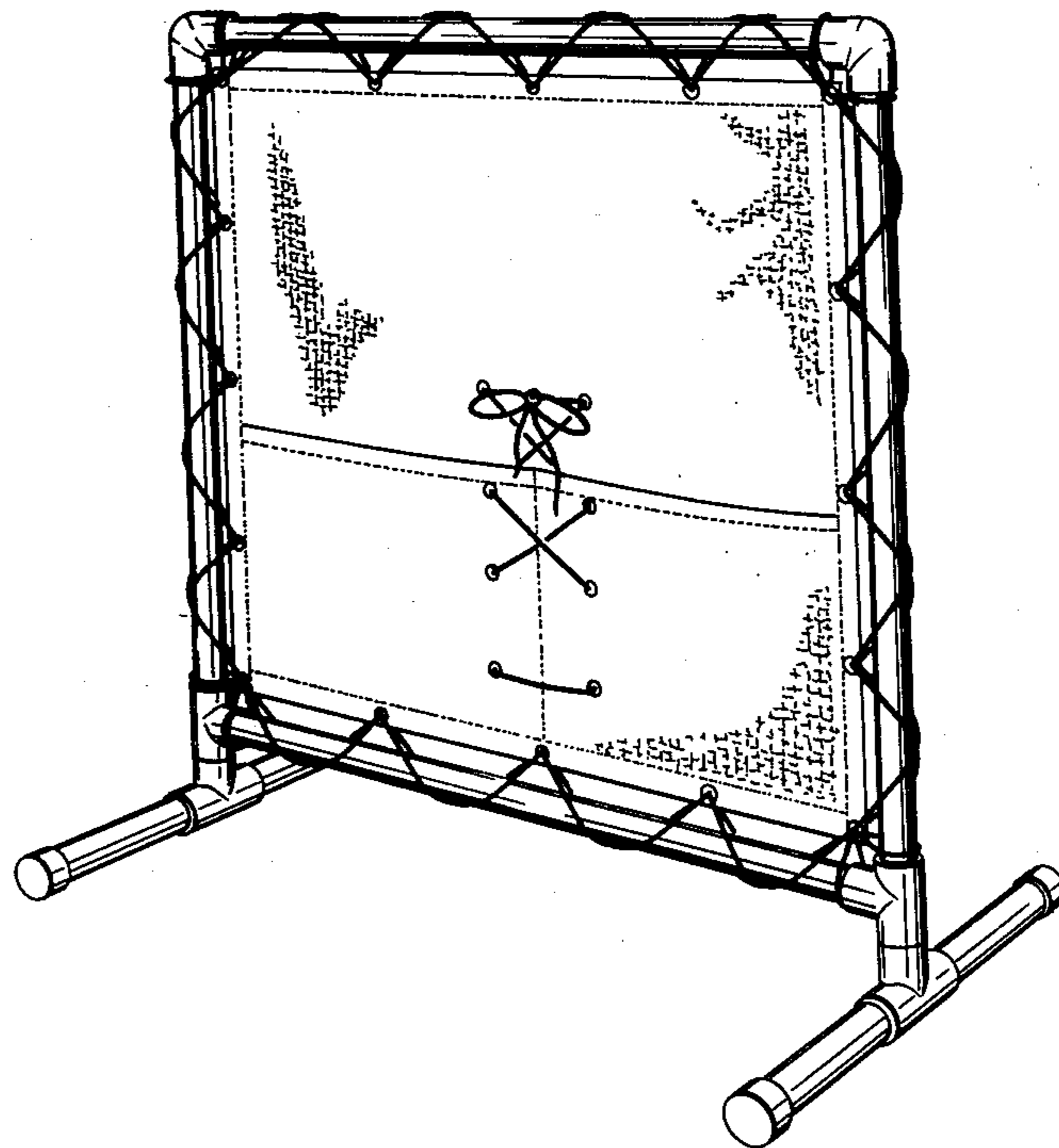

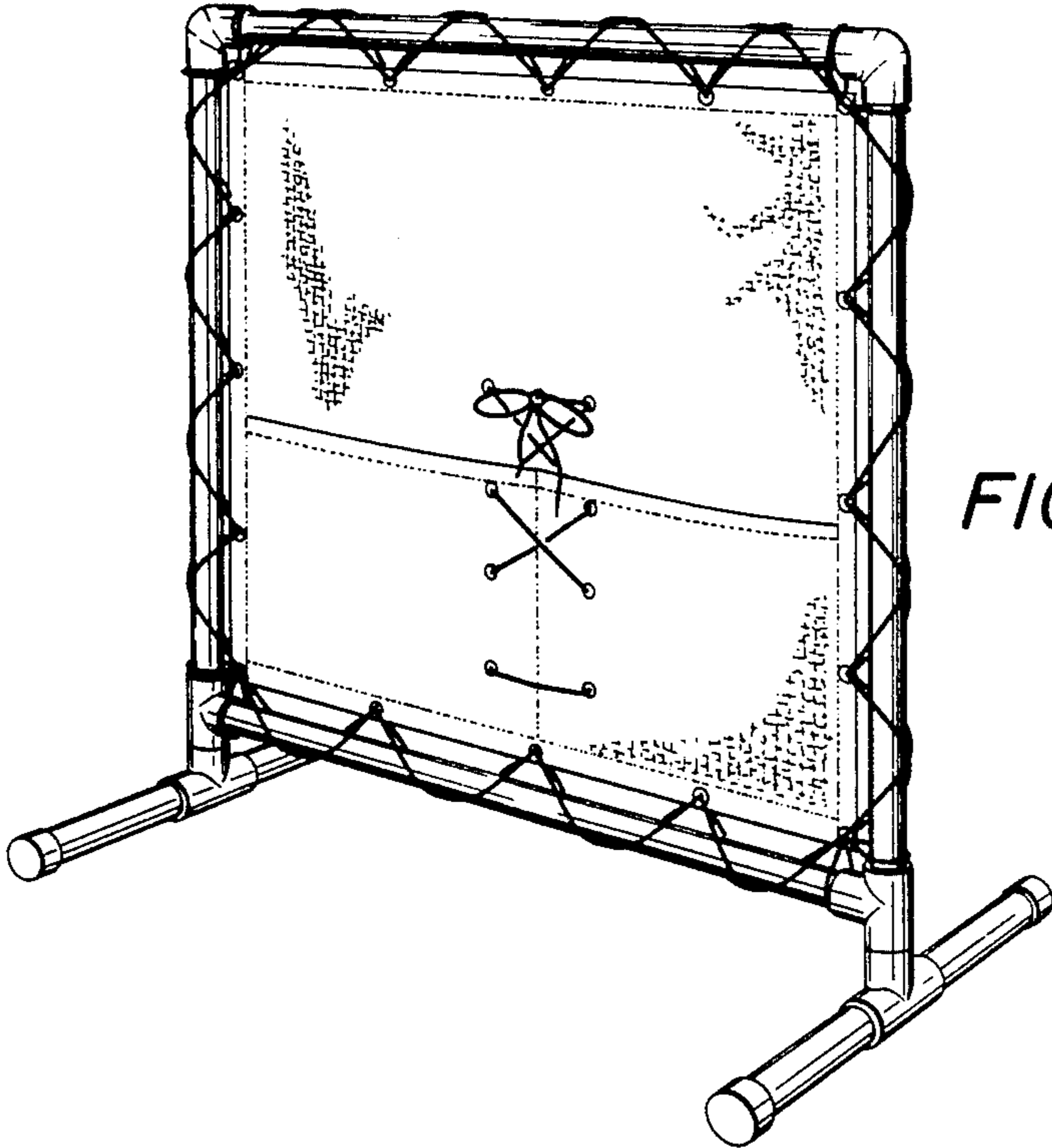

FIG. 1

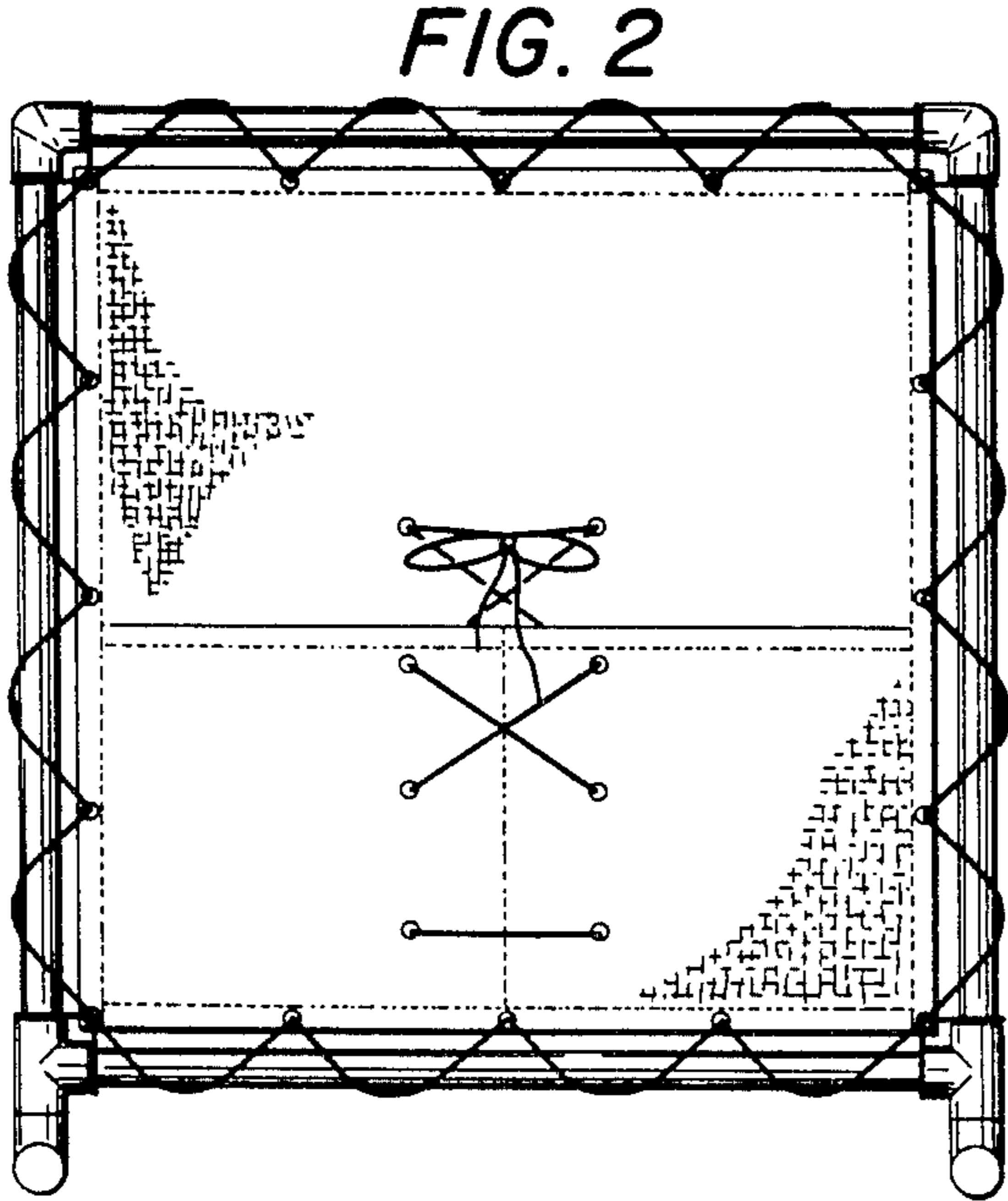

FIG. 2

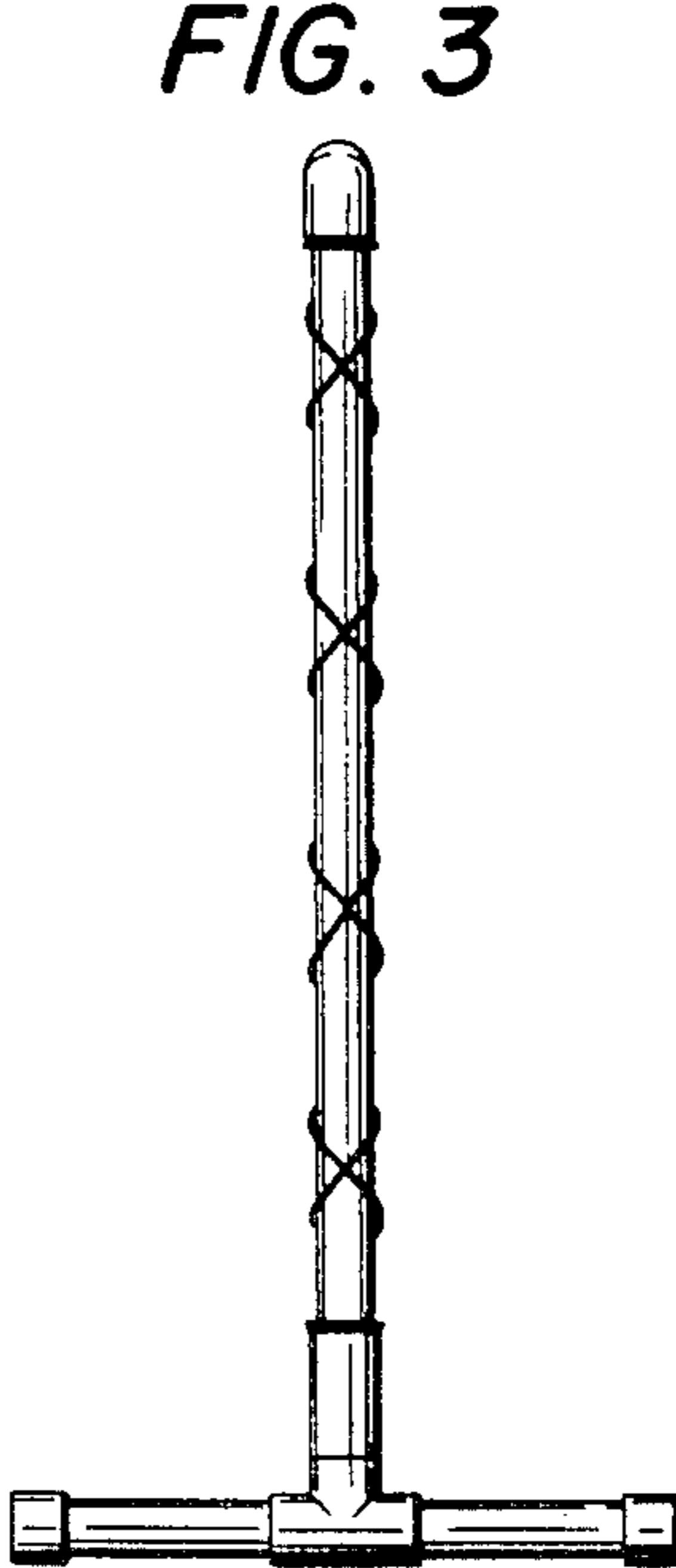

FIG. 3

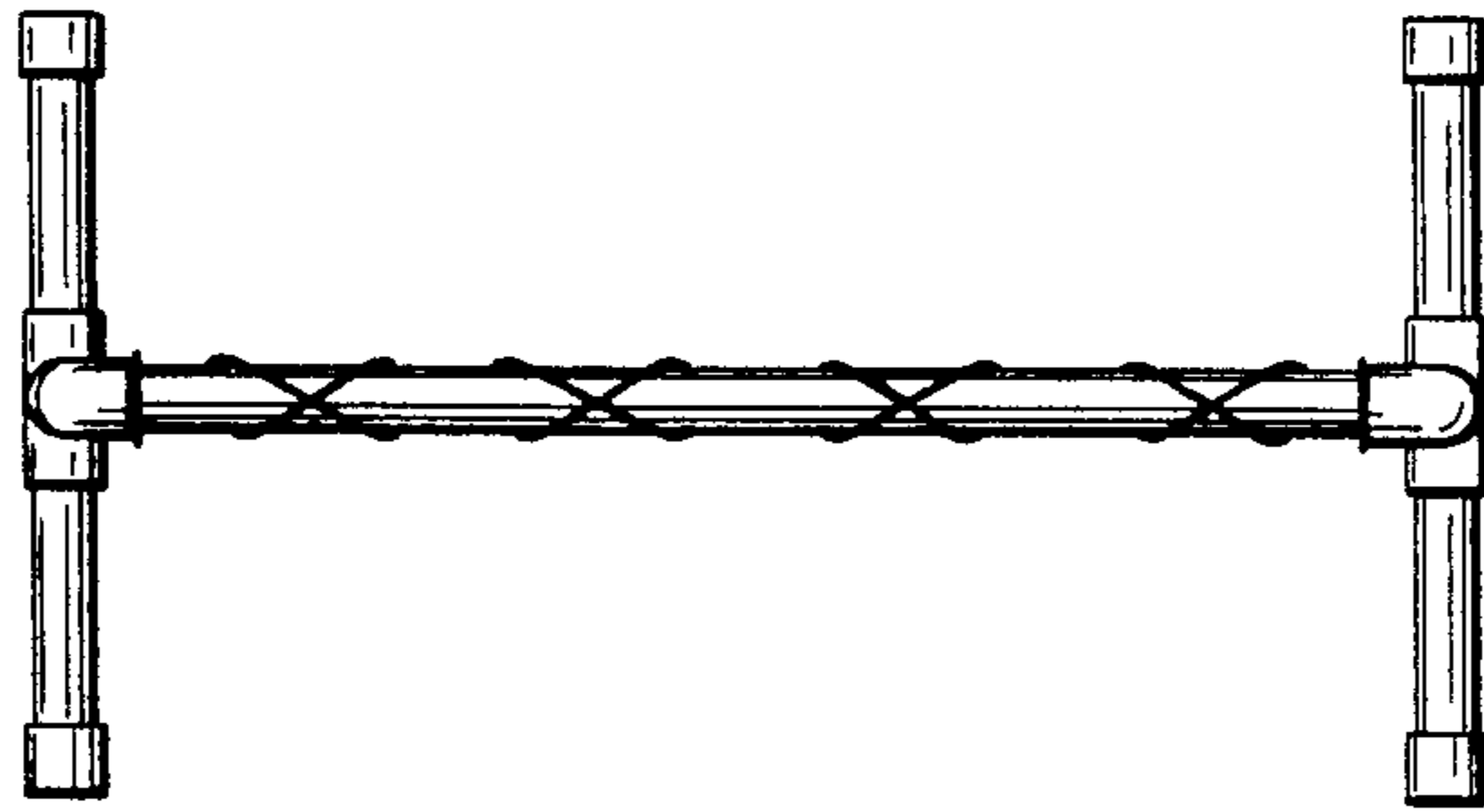

FIG. 4

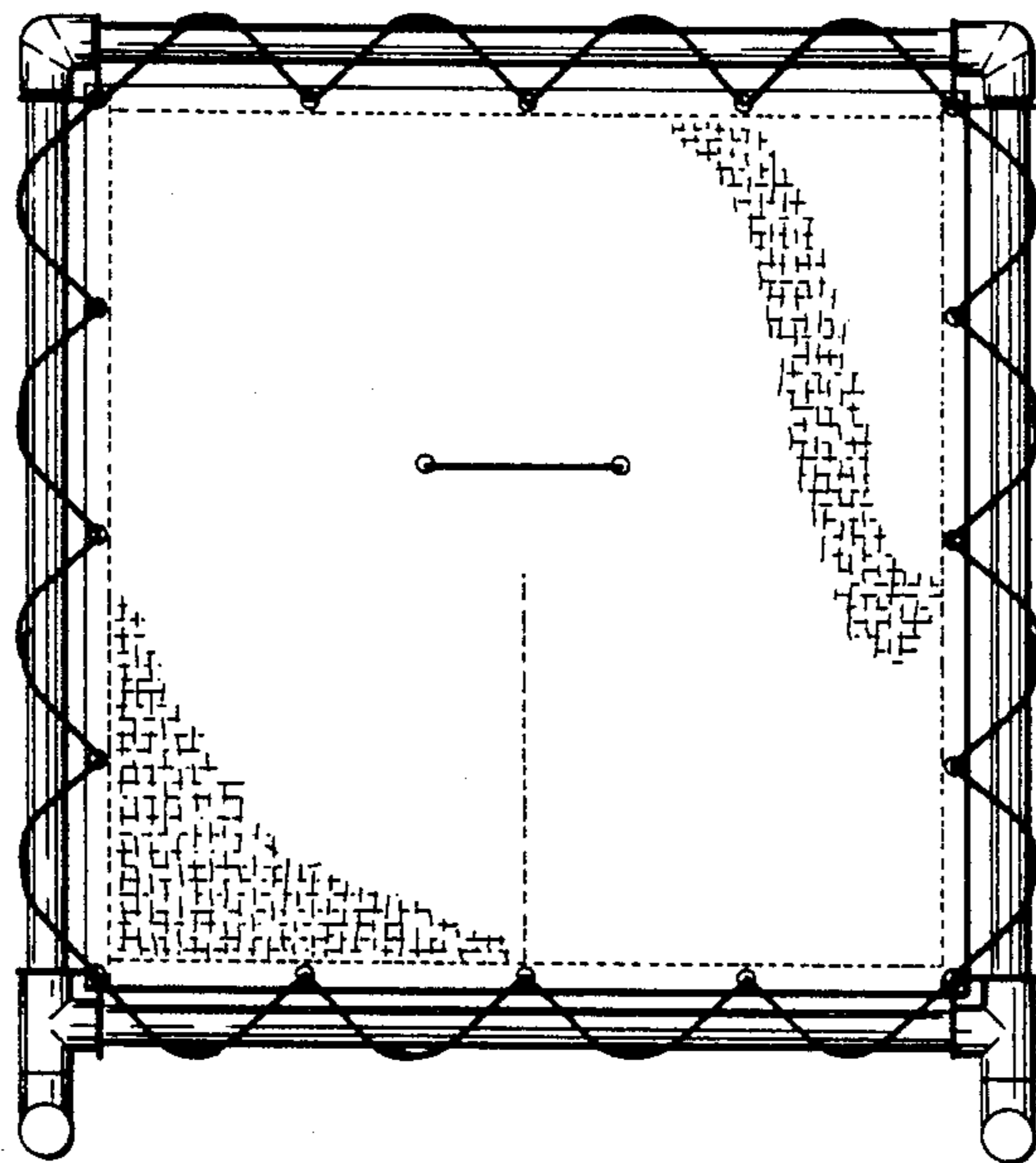

FIG. 5

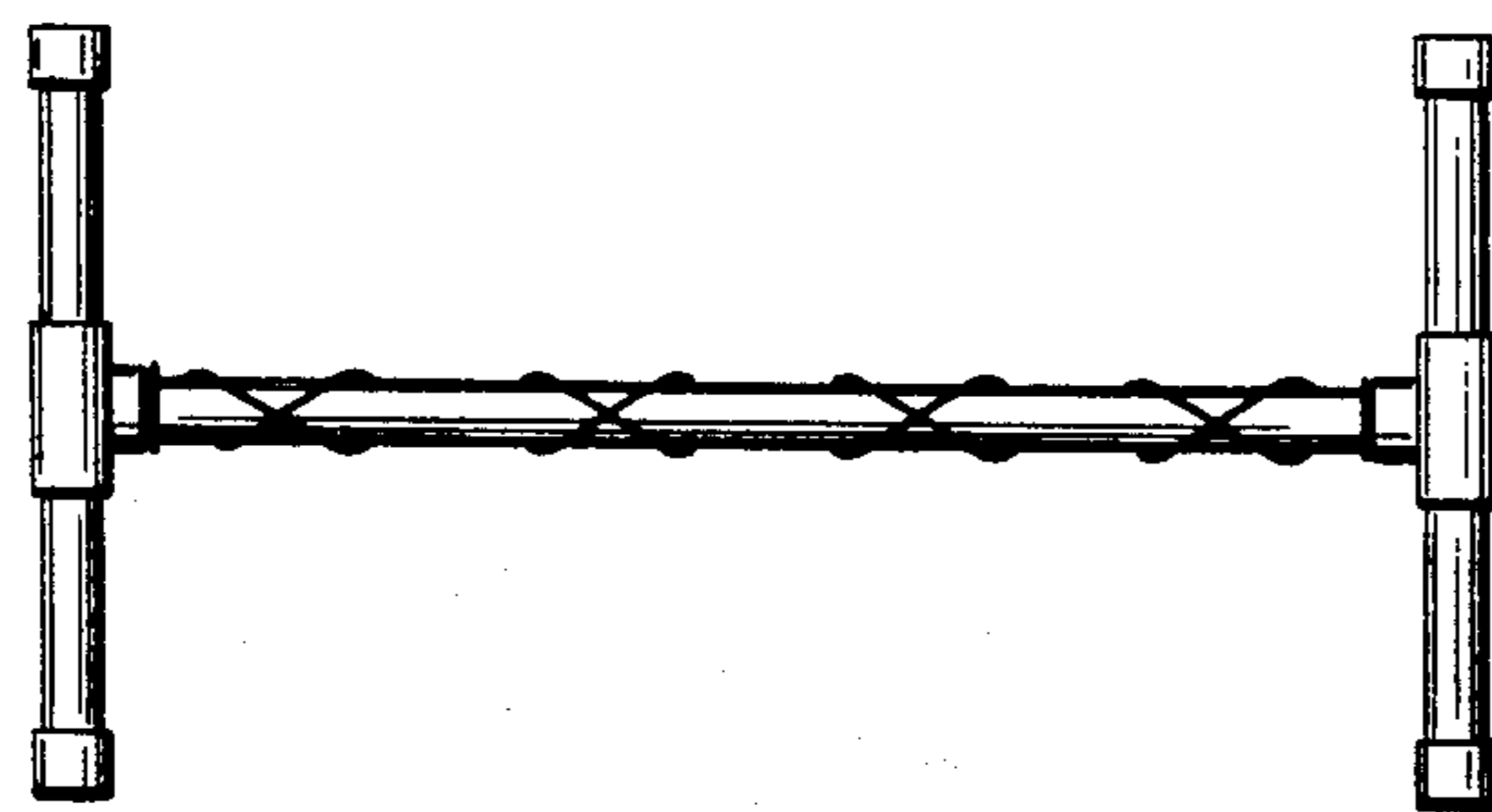

FIG. 6