

United States Patent [19]
Ireland

[11] **Patent Number: Des. 279,906**

[45] **Date of Patent: ** Jul. 30, 1985**

[54] **DRUM LUG**

[75] **Inventor: Roger B. Ireland, Simsbury, Conn.**

[73] **Assignee: C. Bruno & Son, Inc., Bloomfield, Conn.**

[**] **Term: 14 Years**

[21] **Appl. No.: 489,544**

[22] **Filed: Apr. 28, 1983**

[52] **U.S. Cl. D17/22**

[58] **Field of Search D17/22; 84/411 R, 413**

[56] **References Cited**

U.S. PATENT DOCUMENTS

D. 270,167 8/1983 Hoey D17/22
2,092,980 9/1937 Ludwig 84/411 R
3,019,685 2/1962 Davis 84/411 R

4,122,747 10/1978 Yamashita 84/411 R

Primary Examiner—Jane E. Corrigan
Attorney, Agent, or Firm—McCormick, Paulding & Huber

[57] **CLAIM**

The ornamental design for a drum lug, as shown and described.

DESCRIPTION

FIG. 1 is a front, top and right-side perspective view of a drum lug showing my new design;
FIG. 2 is a top plan view;
FIG. 3 is a right-side elevational view;
FIG. 4 is a front elevational view, the rear being identical;
FIG. 5 is a left-side elevational view; and
FIG. 6 is a bottom plan view.

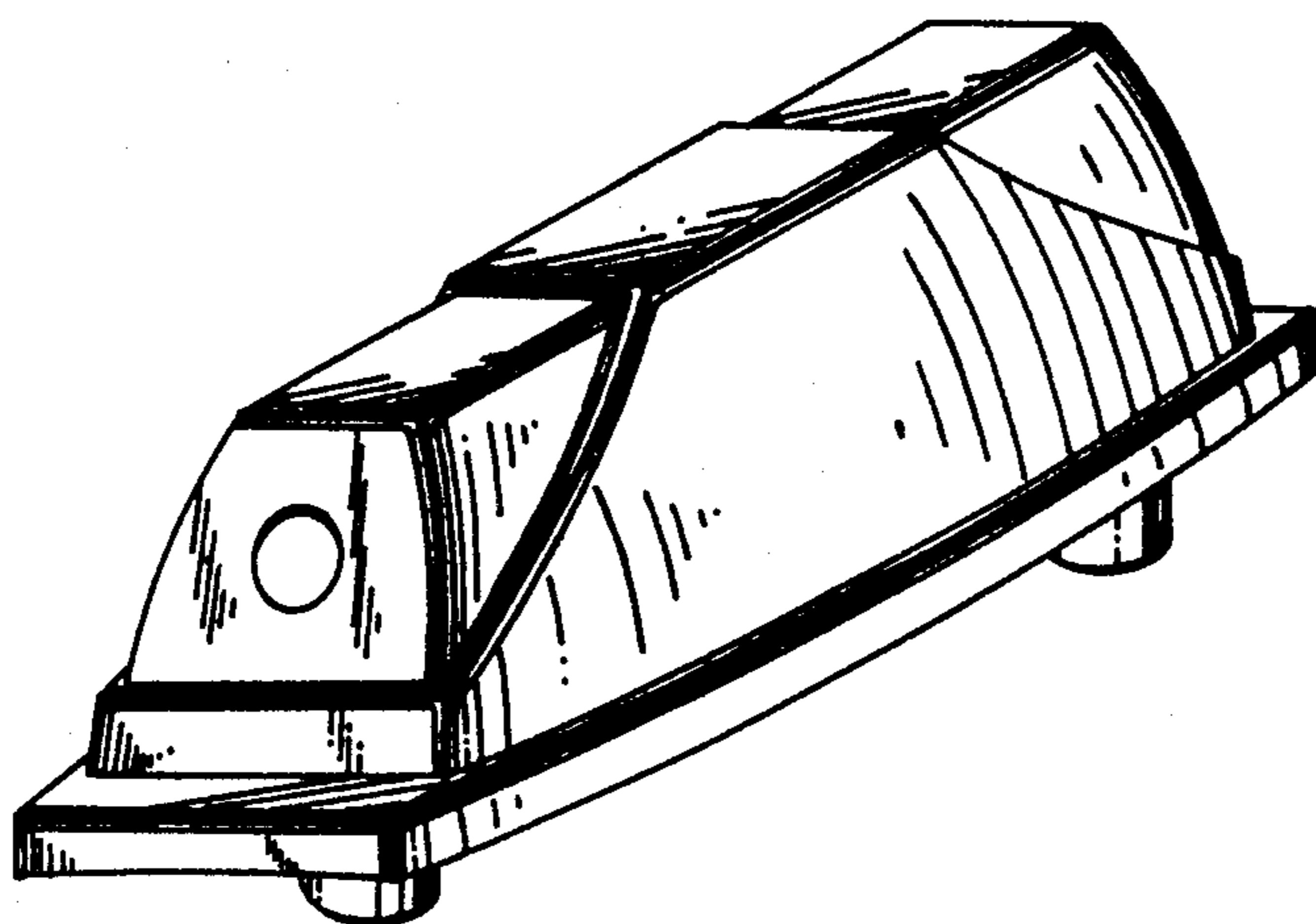

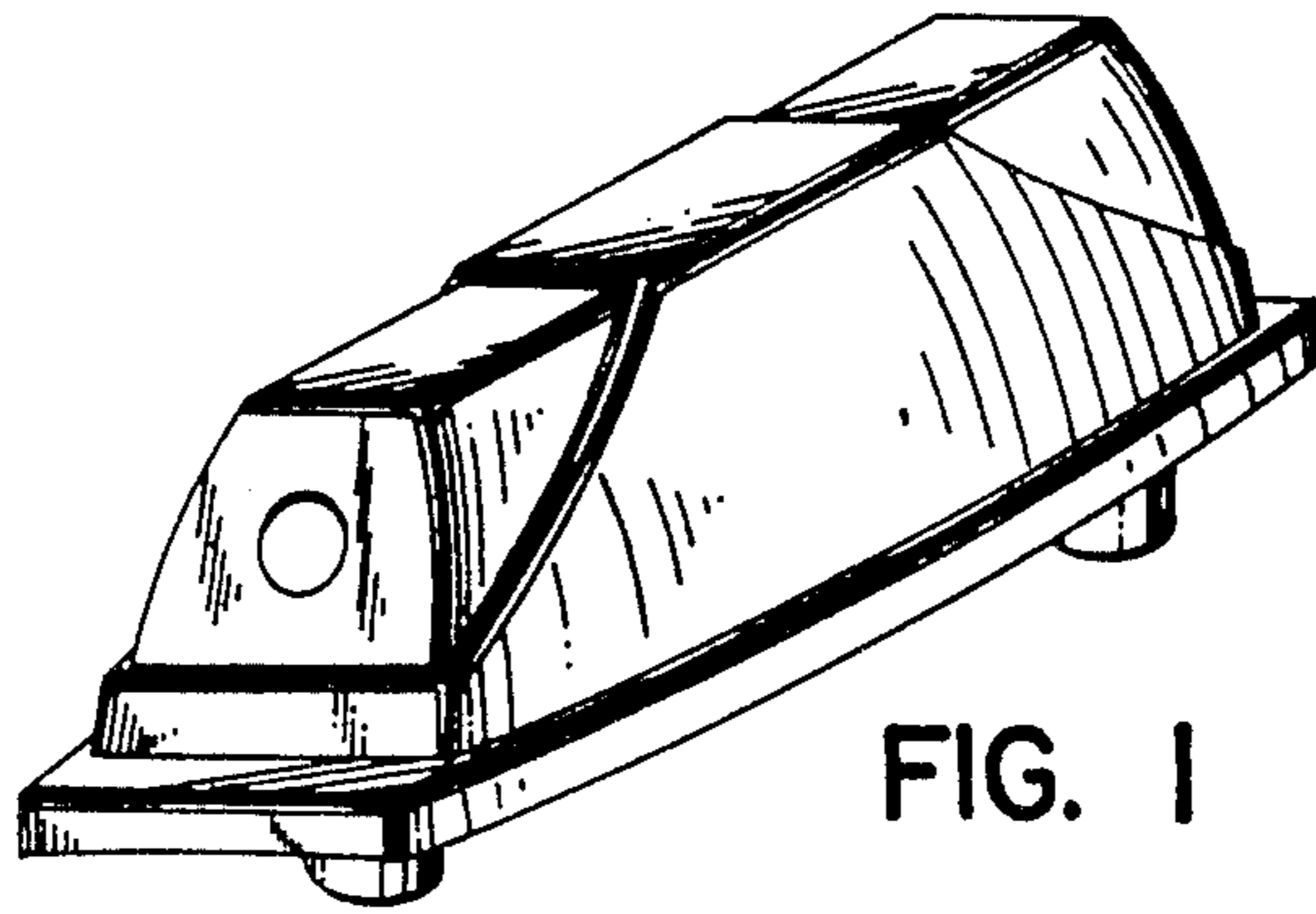

FIG. 1

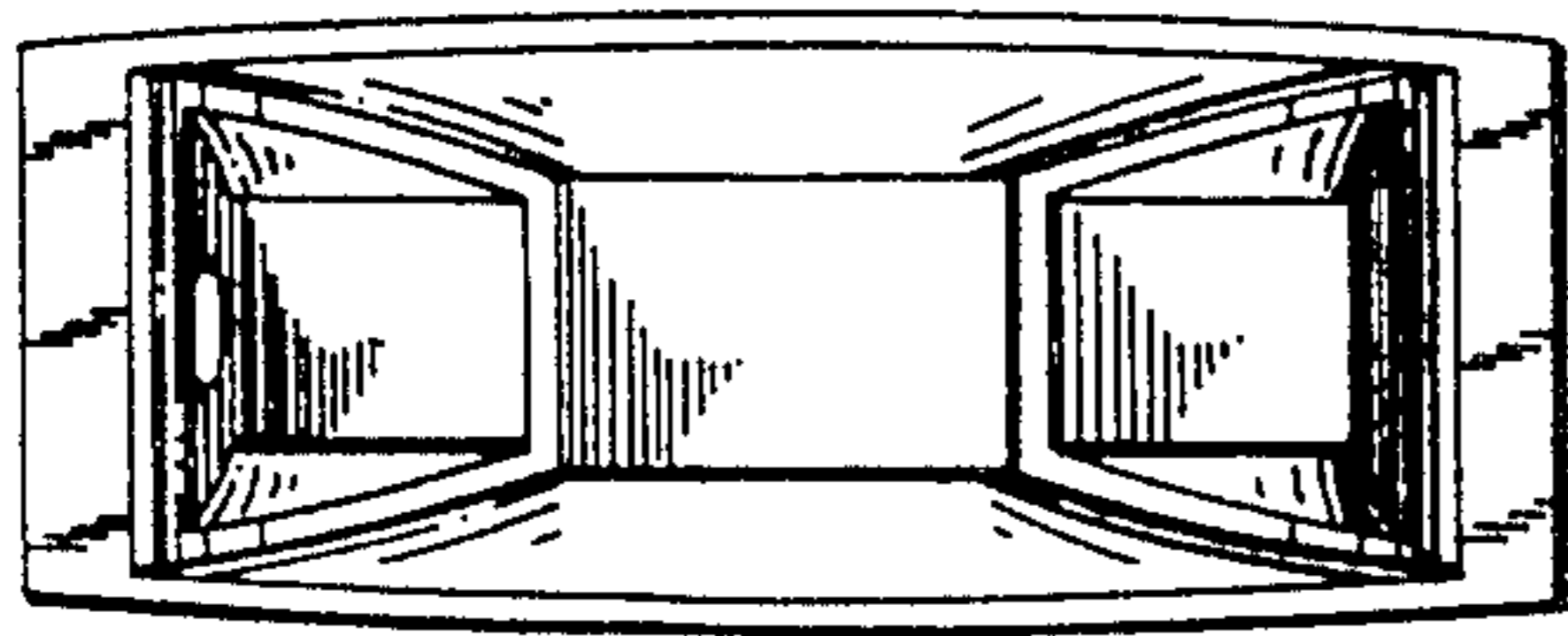

FIG. 2

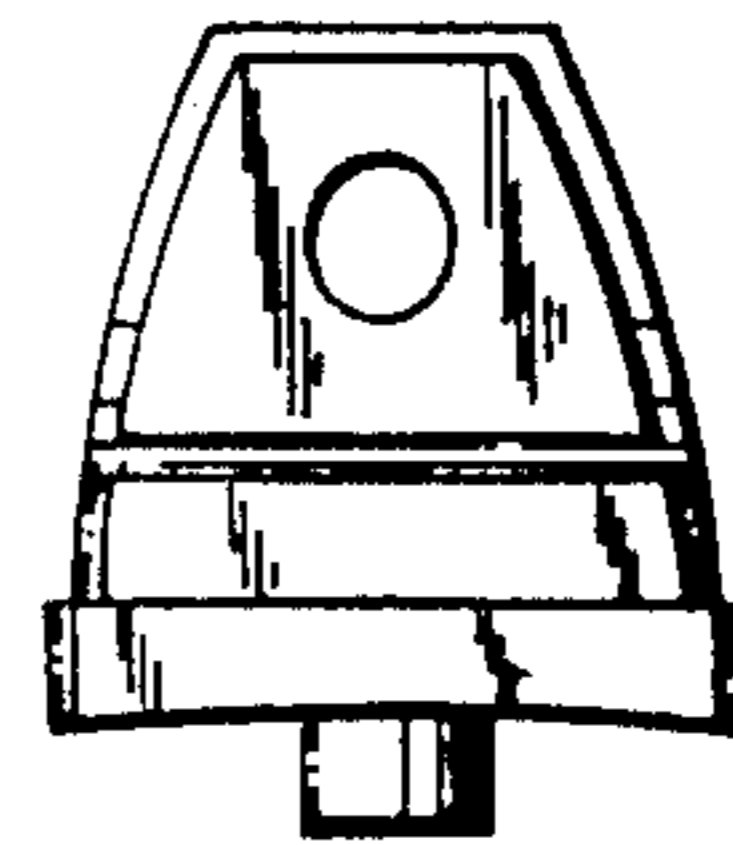

FIG. 3

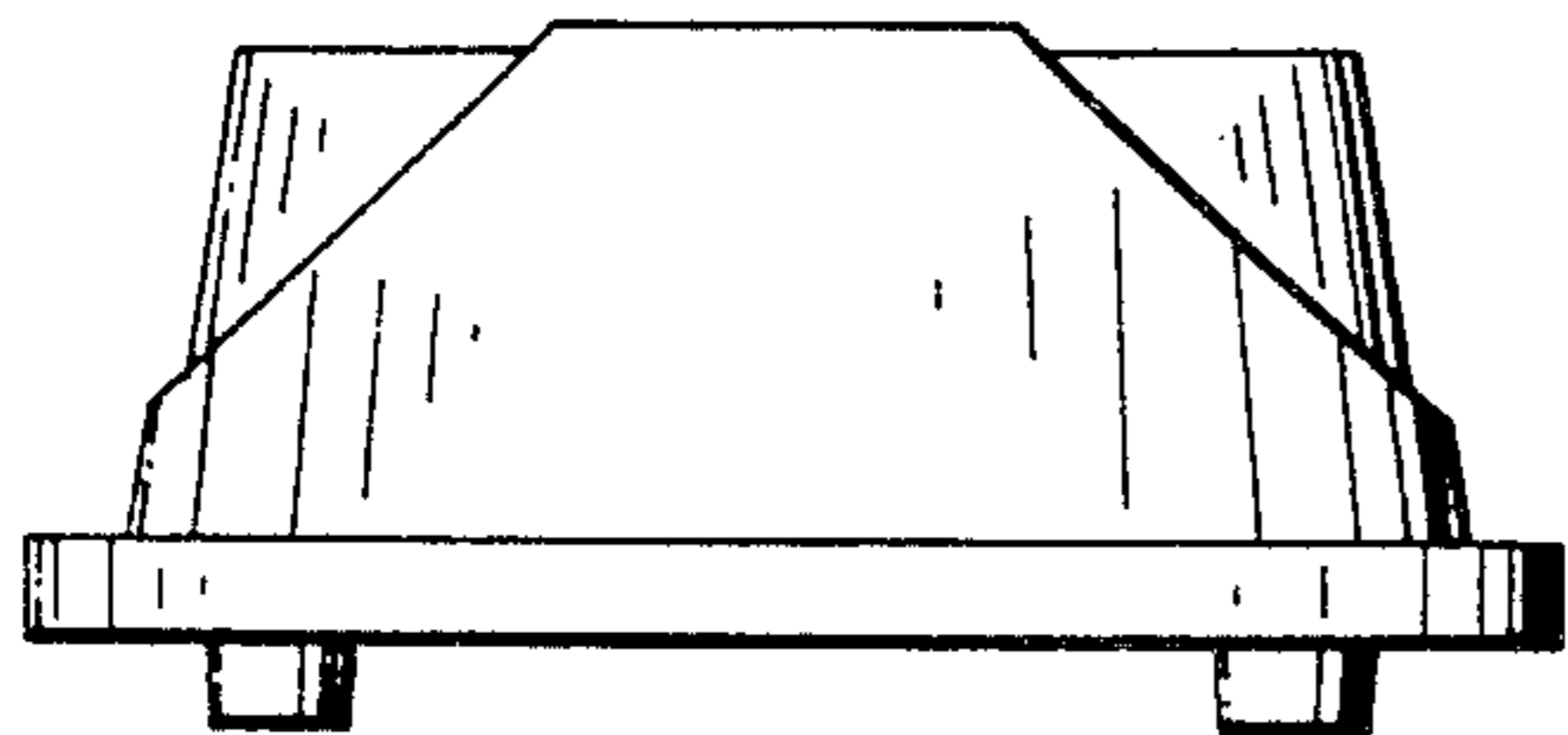

FIG. 4

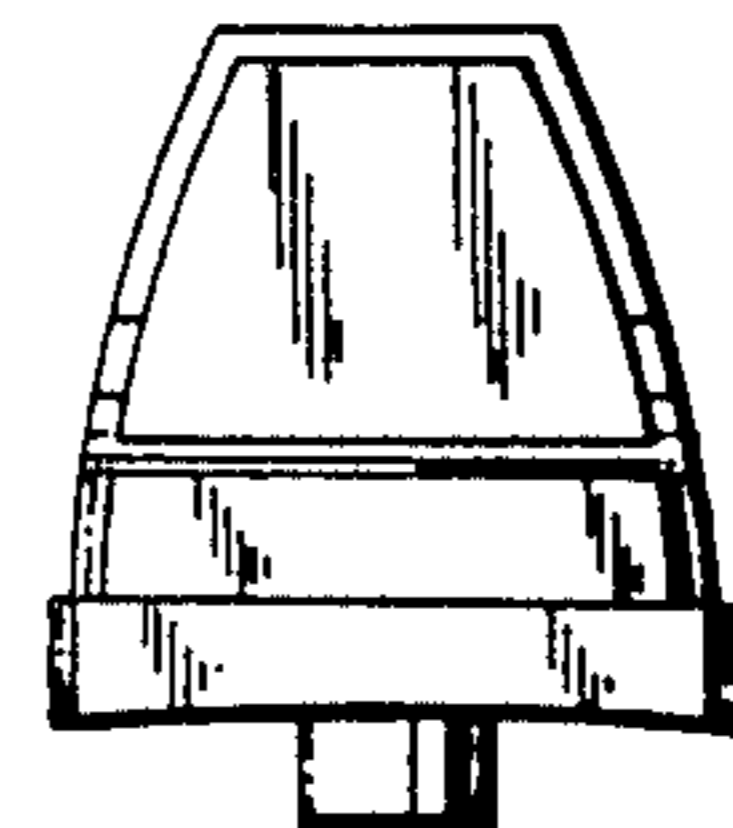

FIG. 5

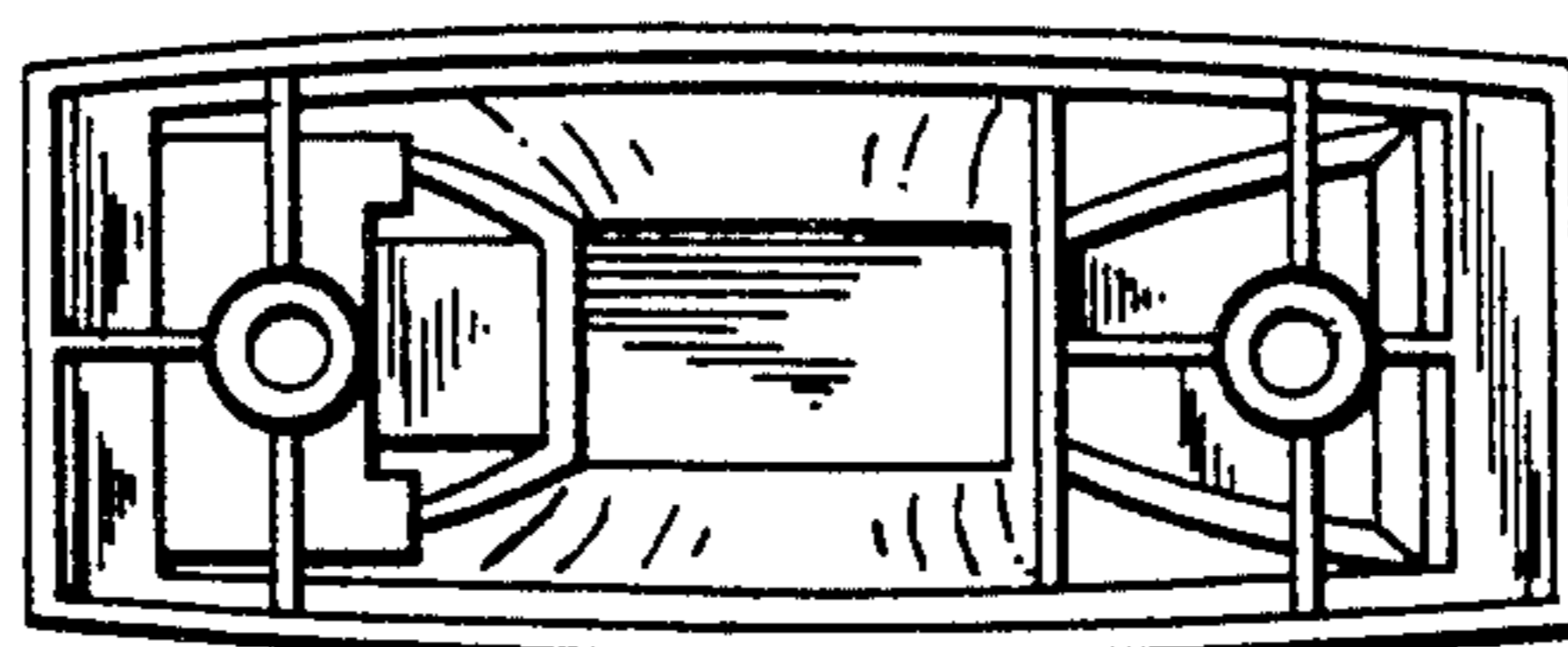

FIG. 6