

[54] WORKTABLE UNIT OR SIMILAR ARTICLE

[75] Inventor: Hartmut H. Esslinger, Altensteig, Fed. Rep. of Germany
[73] Assignee: Konig & Neurath Kommanditgesellschaft, Fed. Rep. of Germany

[**] Term: 14 Years

[21] Appl. No.: 465,499

[22] Filed: Feb. 10, 1983

[52] U.S. Cl. D6/483; D6/484

[58] Field of Search D6/422, 423, 479, 449, D6/477, 480, 483, 484, 486

[56] References Cited

U.S. PATENT DOCUMENTS

D. 202,194	9/1965	Propst et al.	D6/479 X
D. 239,227	3/1976	Vogt	D6/423 X
D. 263,530	3/1982	Liljequist	D6/422 X

OTHER PUBLICATIONS

Scandiline brochure, desk unit at right.

Primary Examiner—Bruce W. Dunkins
Attorney, Agent, or Firm—Thomas W. Speckman

[57] CLAIM

The ornamental design for a worktable unit or similar article, substantially as shown and described.

DESCRIPTION

FIG. 1 is a perspective view of a worktable unit or similar article showing my design;
FIG. 2 is a side view;
FIG. 3 is a top plan view; and
FIG. 4 is a front elevational view thereof;
FIG. 5 is a perspective view of a worktable unit or similar article showing a second embodiment of my design;
FIG. 6 is a side view of a worktable unit or similar article showing a third embodiment of my design; and
FIG. 7 is a front elevational view of a worktable unit or similar article showing a fourth embodiment of my design.

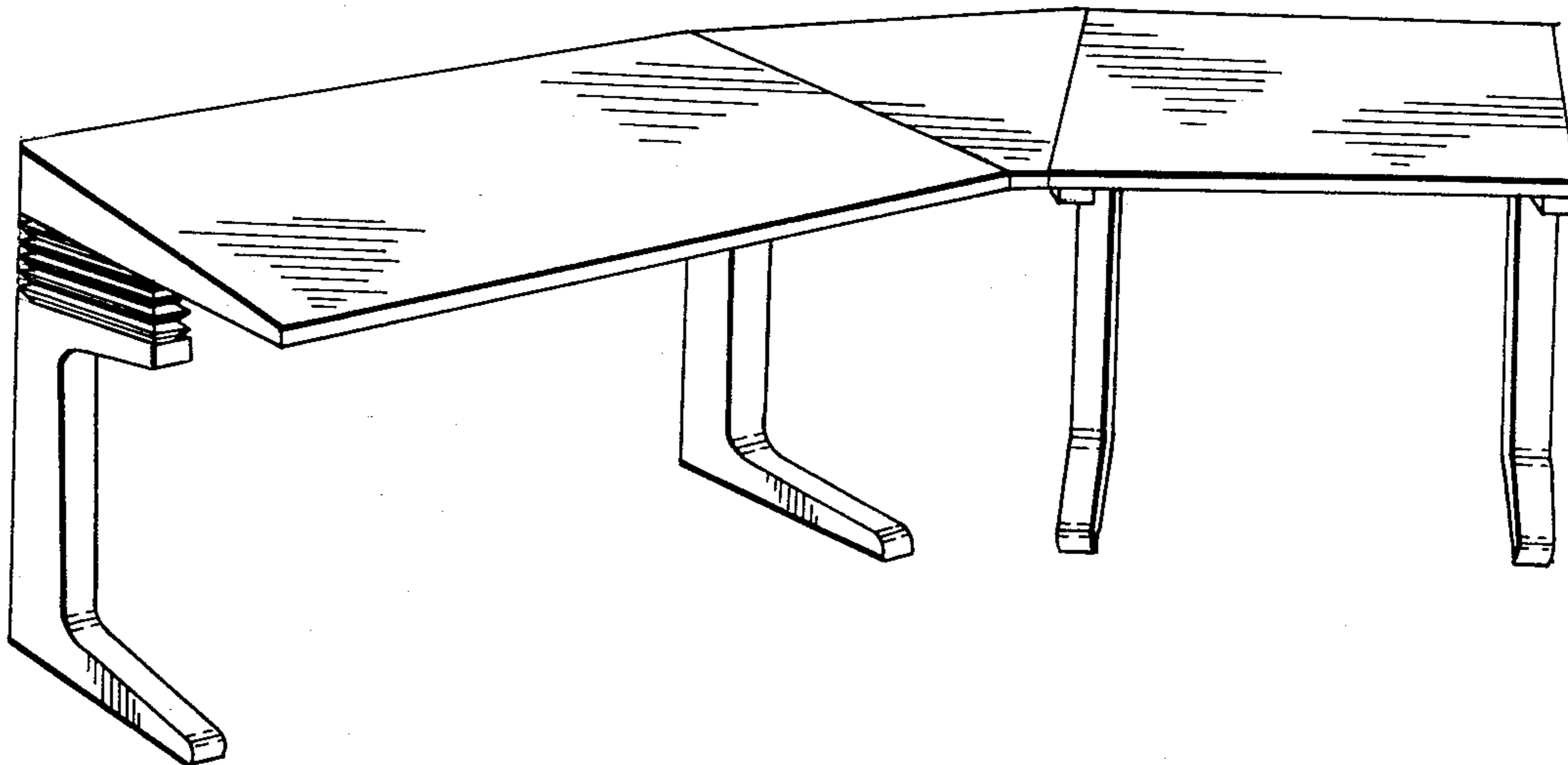

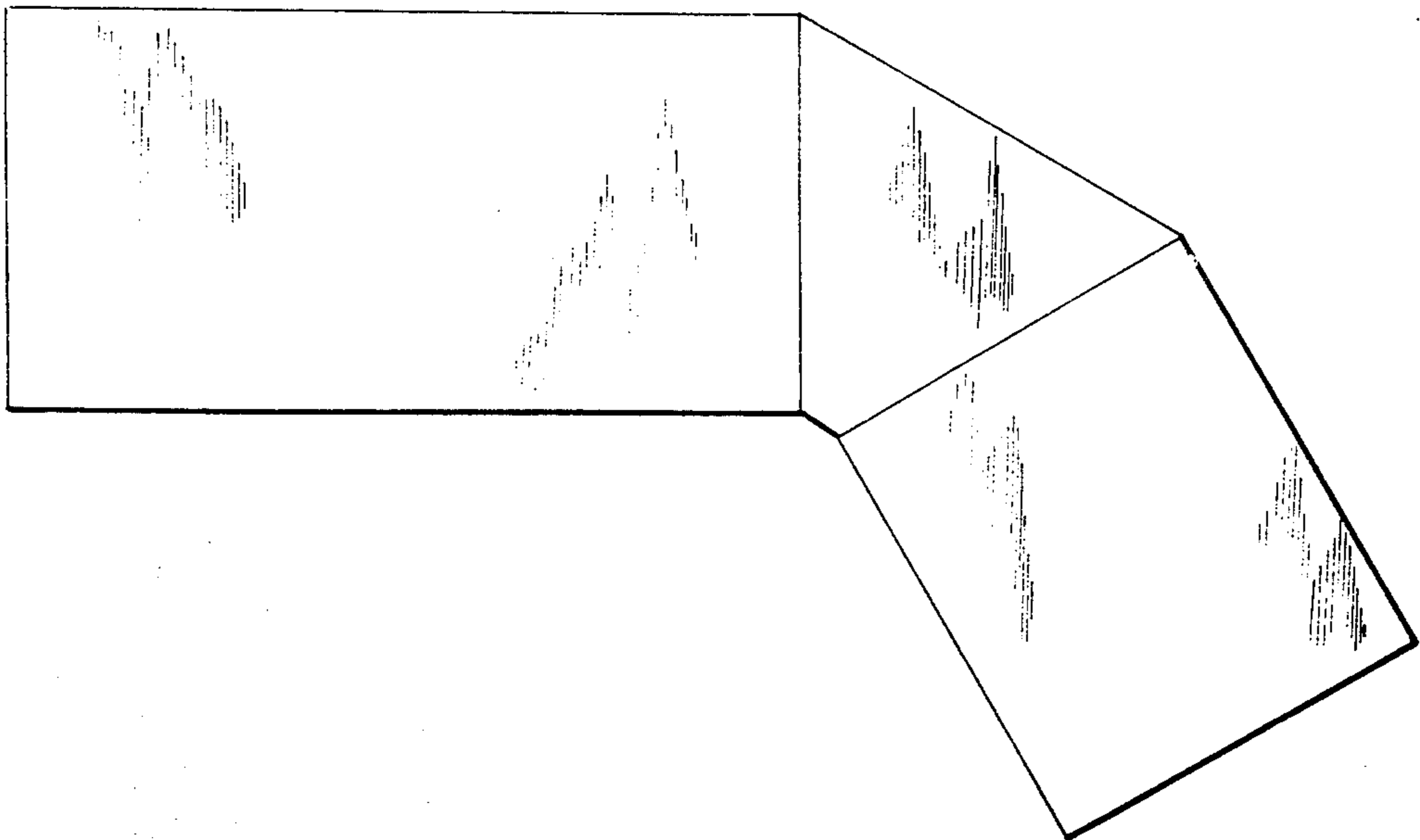
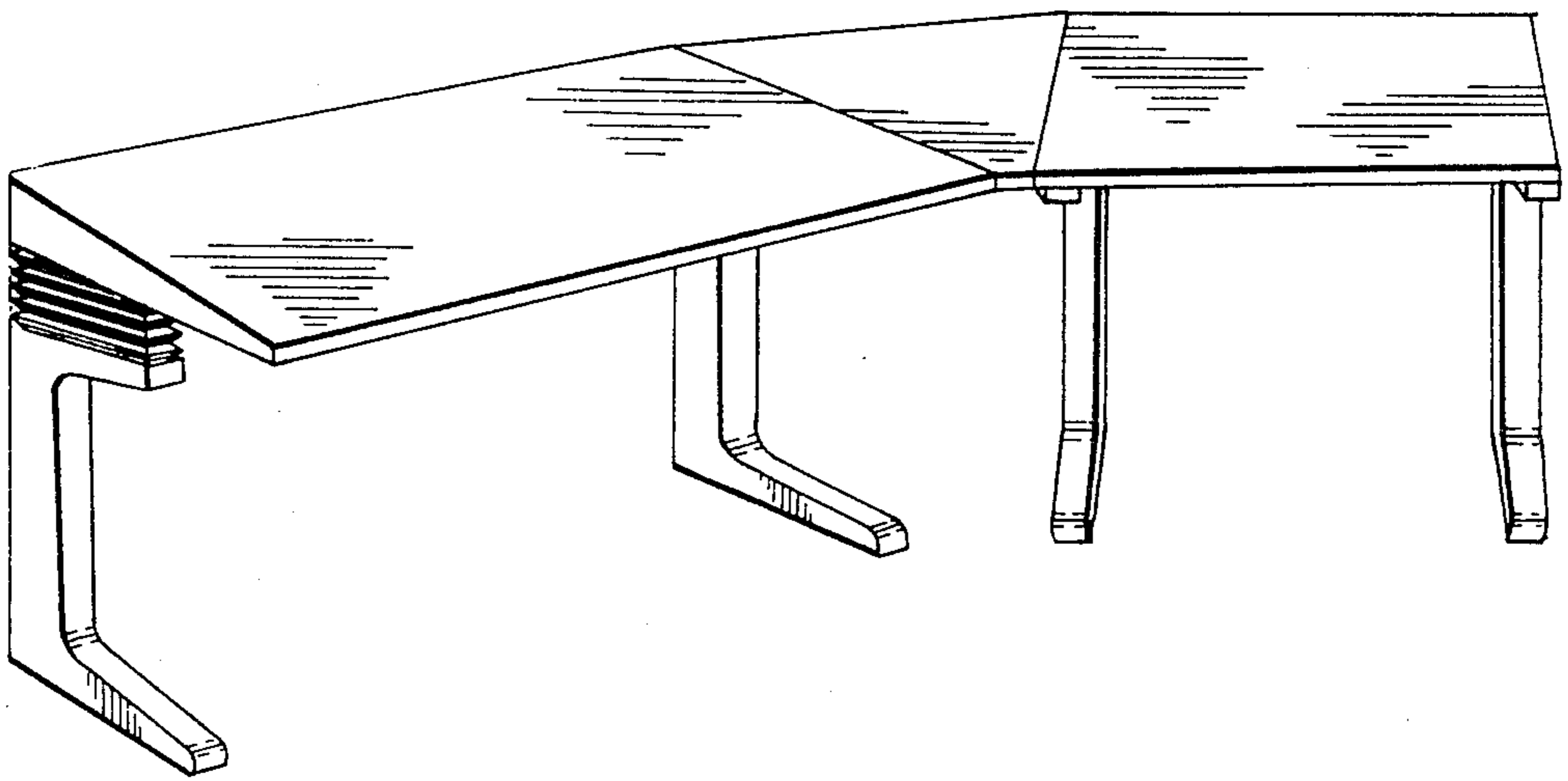
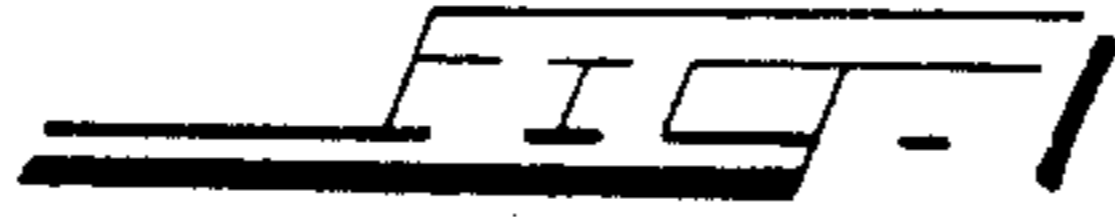

FIG-2

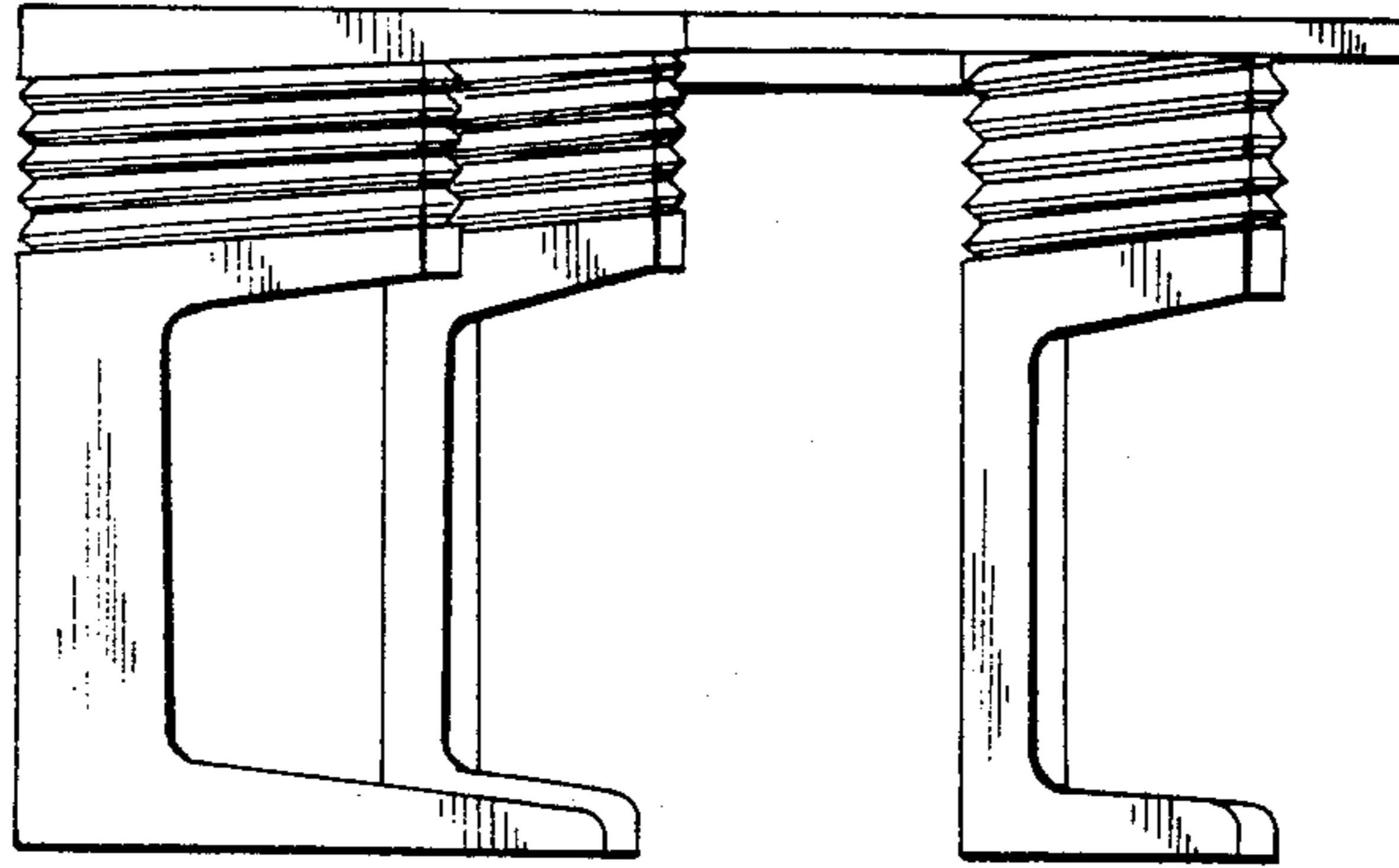

FIG-4

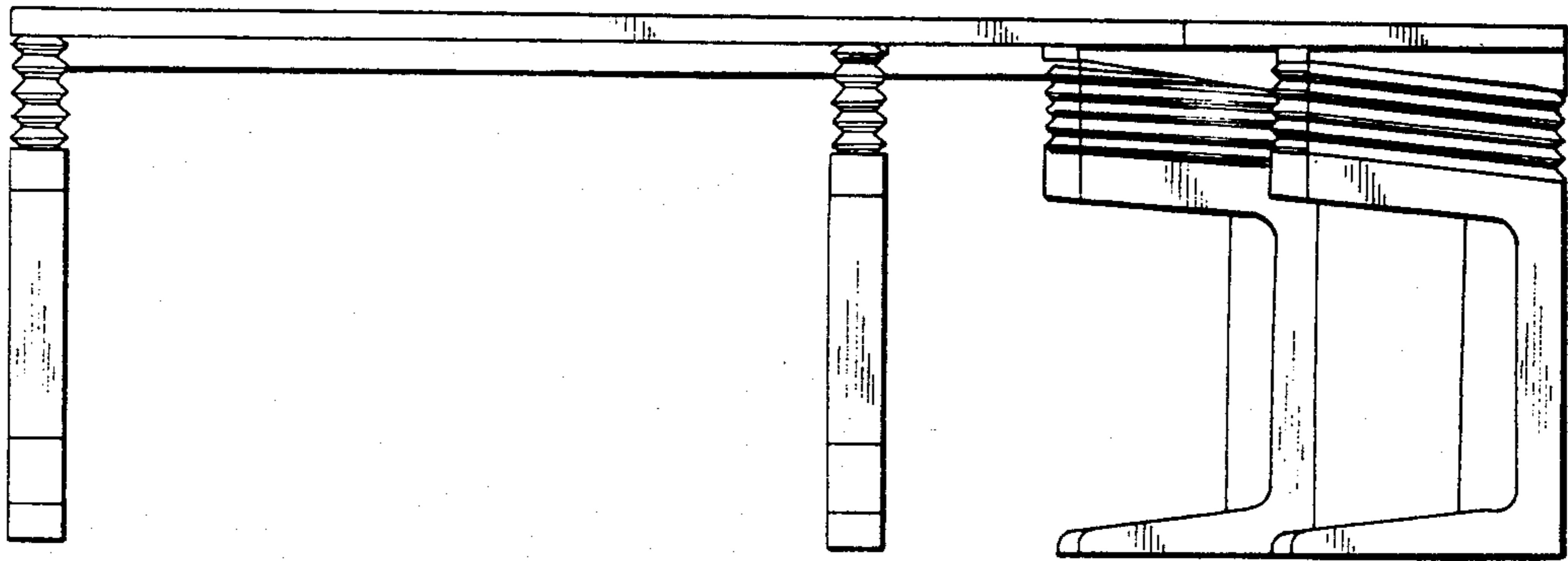

FIG-5

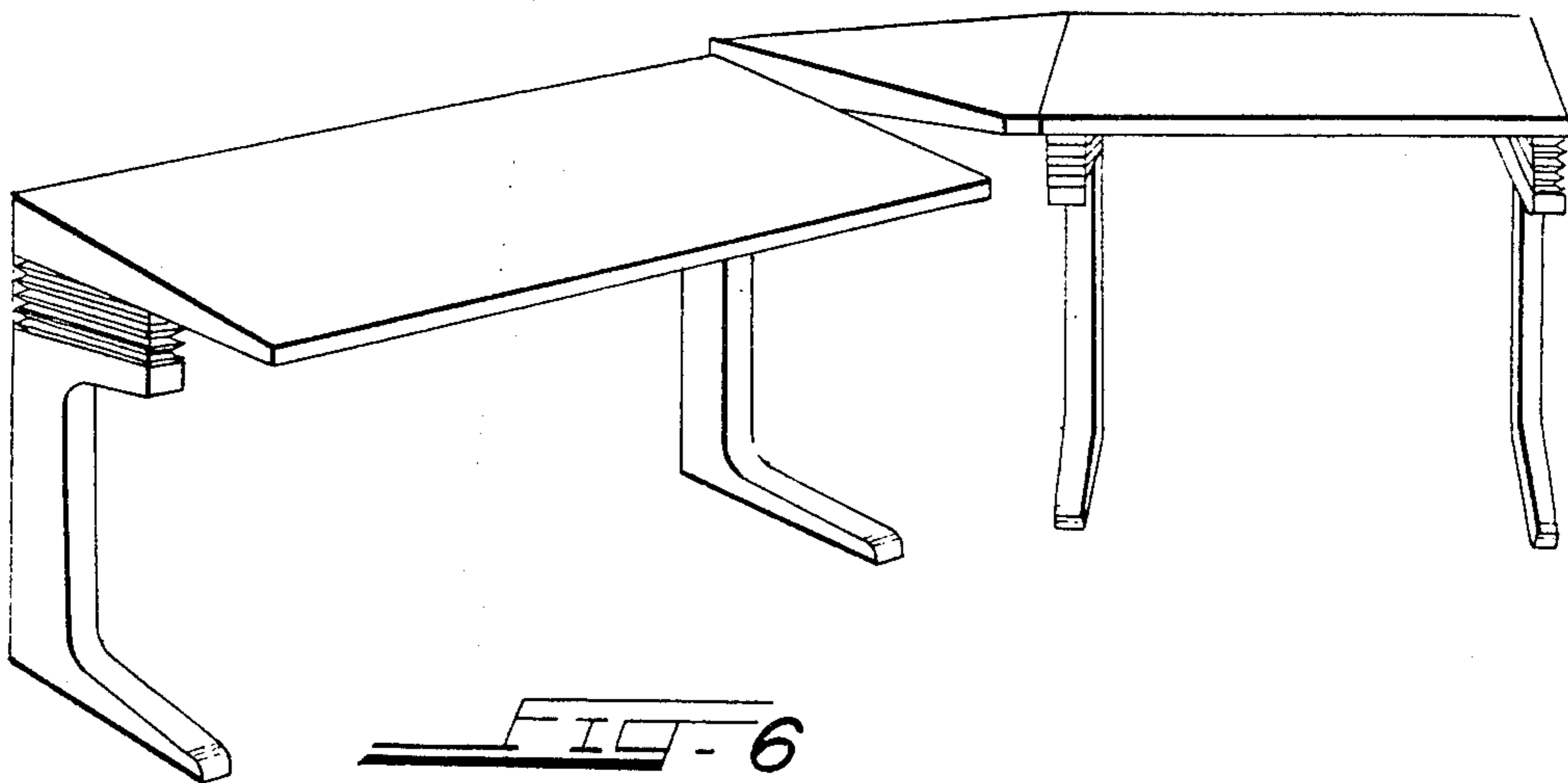

FIG-6

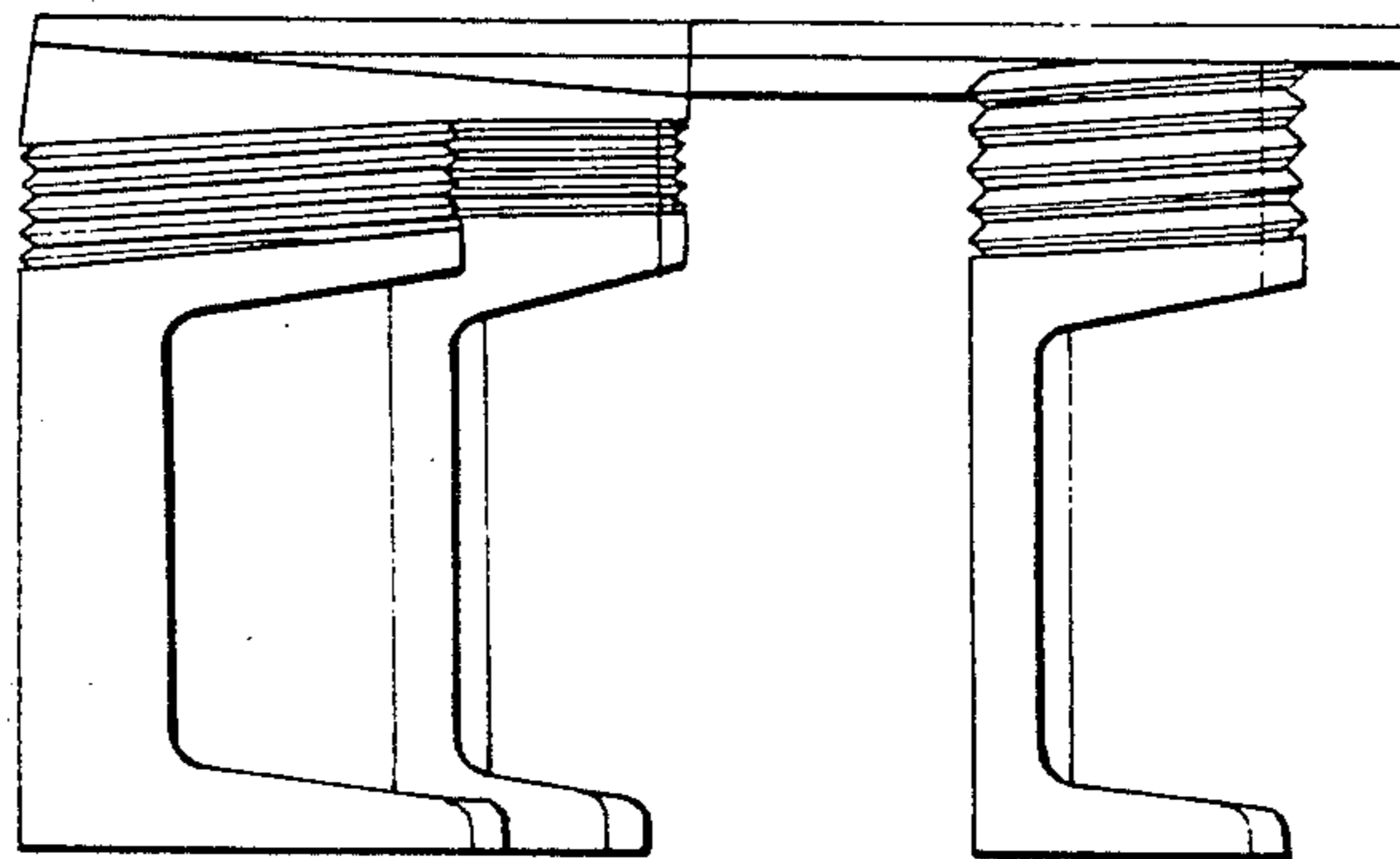

FIG-7

