

[54] OVER WHEEL WELL TRUCK TOOL BOX

[75] Inventor: John E. Waters, Jr., Waco, Tex.

[73] Assignee: Advanced Plastics, Inc., Jonesboro, Ark.

[**] Term: 14 Years

[21] Appl. No.: 566,590

[22] Filed: Dec. 29, 1983

[52] U.S. Cl. D12/157

[58] Field of Search D12/157; D3/40, 78; 224/42.11, 42.42, 42.46 R; 296/37.6

[56] References Cited

U.S. PATENT DOCUMENTS

D. 271,009 10/1983 Fishler D12/157

OTHER PUBLICATIONS

J. C. Whitney Catalog No. 366F, ©1977, p. 48, Piggy-back Storage Box , lower right side of page.

Primary Examiner—James M. Gandy
Attorney, Agent, or Firm—Crutsinger, Booth & Ross

[57] CLAIM

The ornamental design for an over wheel well truck tool box, as shown and described.

DESCRIPTION

FIG. 1 is a perspective view showing the bottom front and right hand side of my over wheel well truck tool box;

FIG. 2 is a perspective view showing the front, left side and top of the tool box of FIG. 1;

FIG. 3 is a top plan view of the tool box of FIG. 1;

FIG. 4 is a bottom plan view of the tool box of FIG. 1;

FIG. 5 is a right side elevation view of the tool box of FIG. 1, the left side being a mirror image thereof as may be seen from FIG. 2;

FIG. 6 is a front end elevation view of the tool box of FIG. 1; and

FIG. 7 is a rear end elevation view of the tool box of FIG. 1.

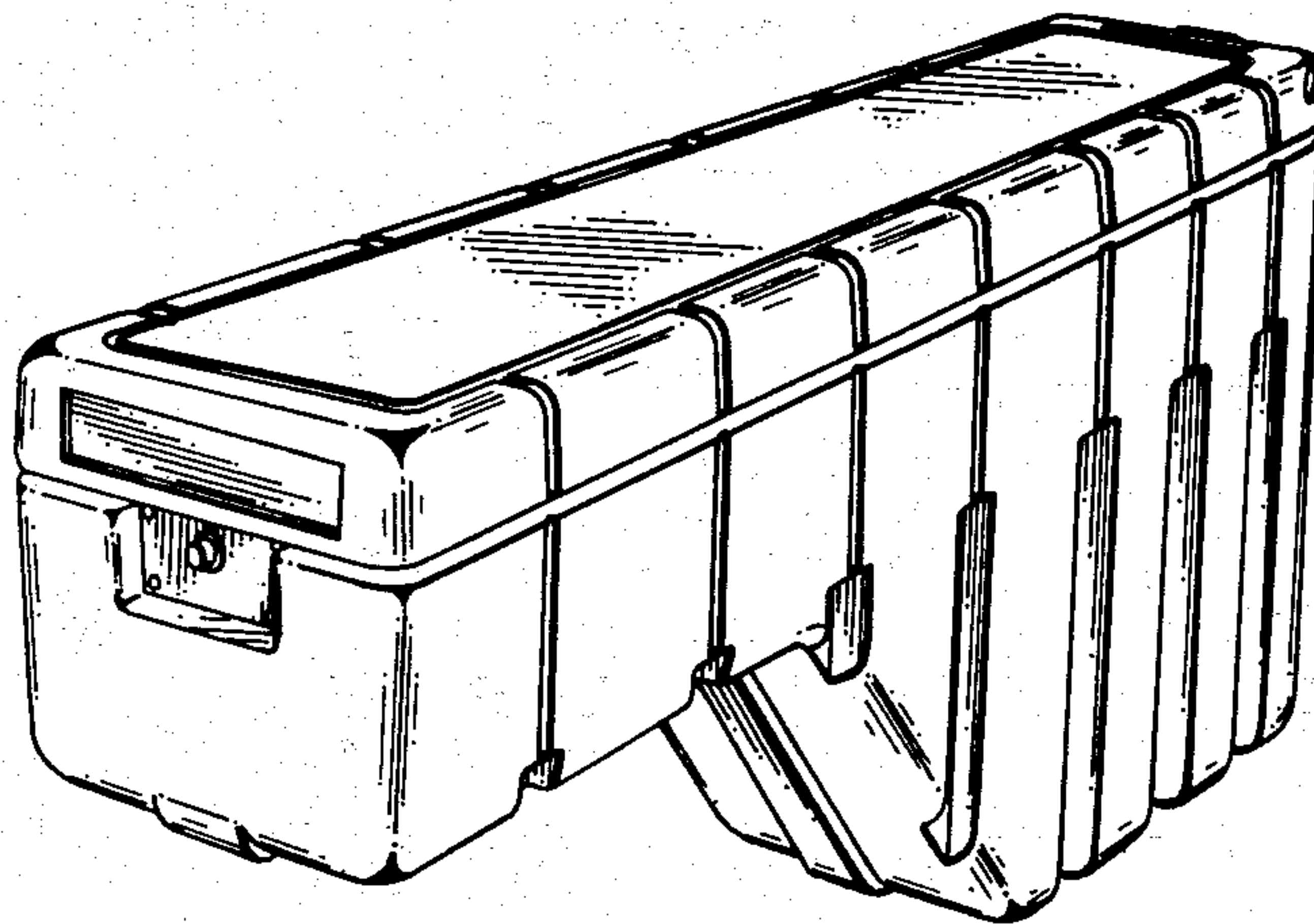

FIG. 1

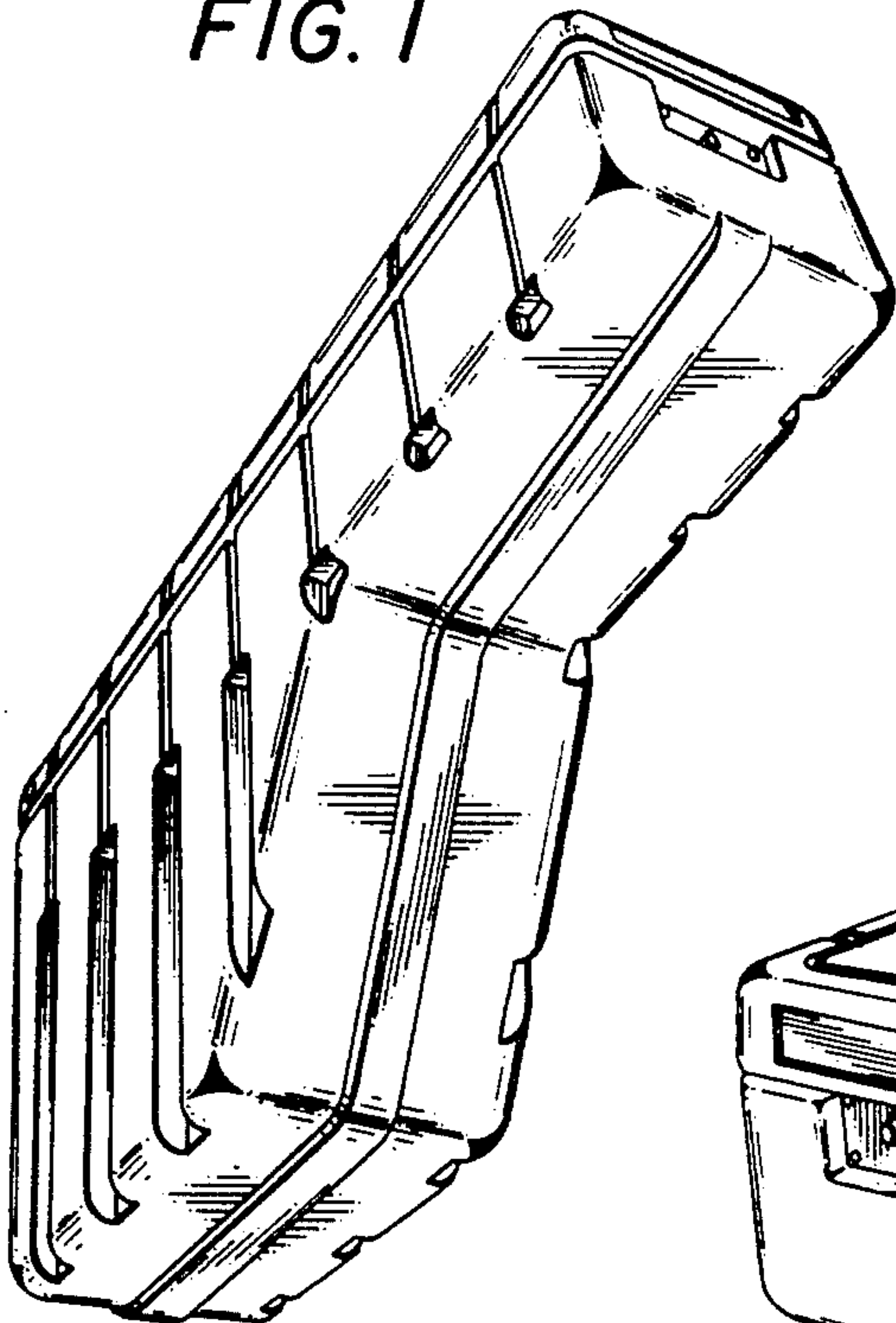

FIG. 2

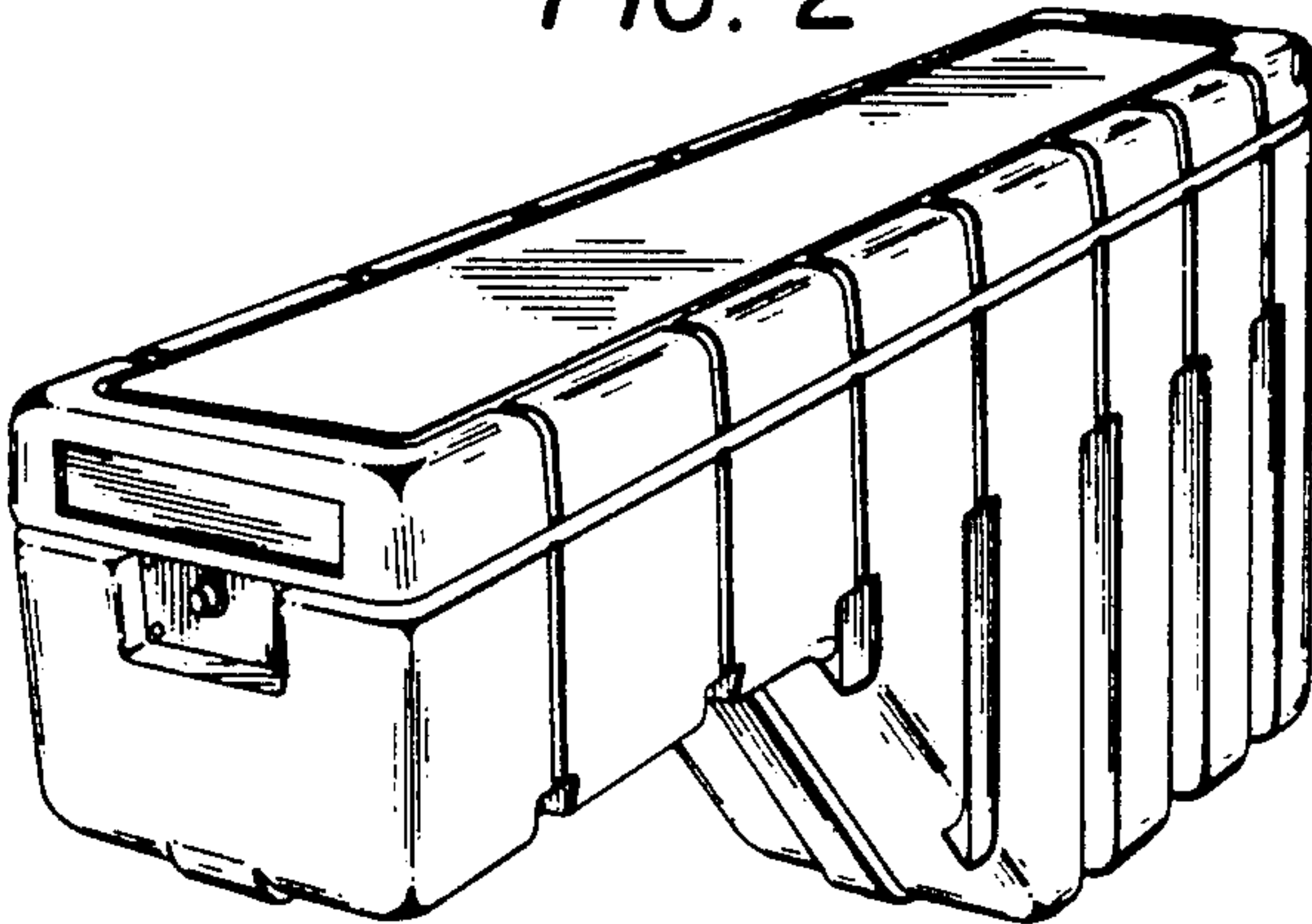

FIG. 3

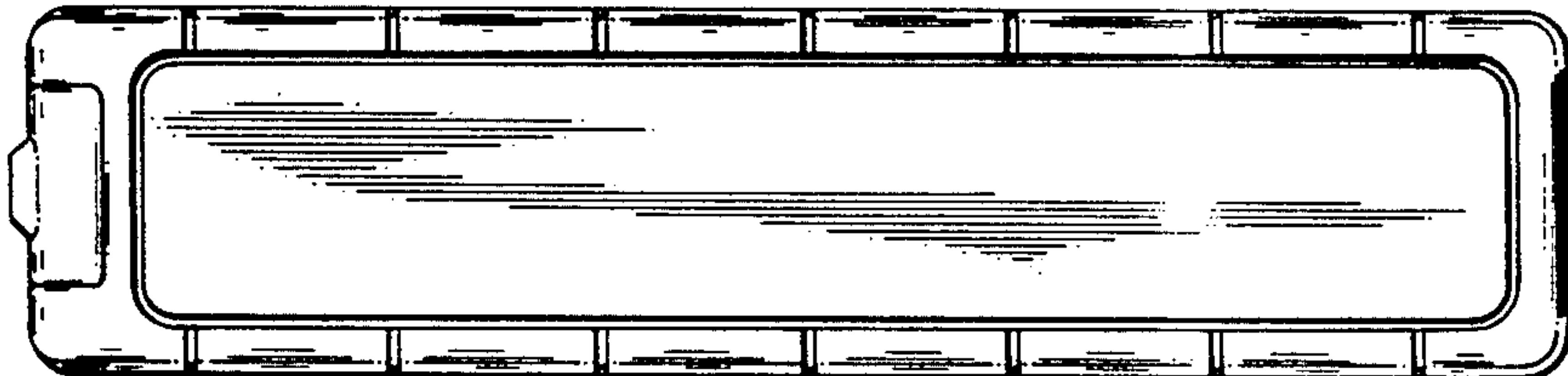

FIG. 4

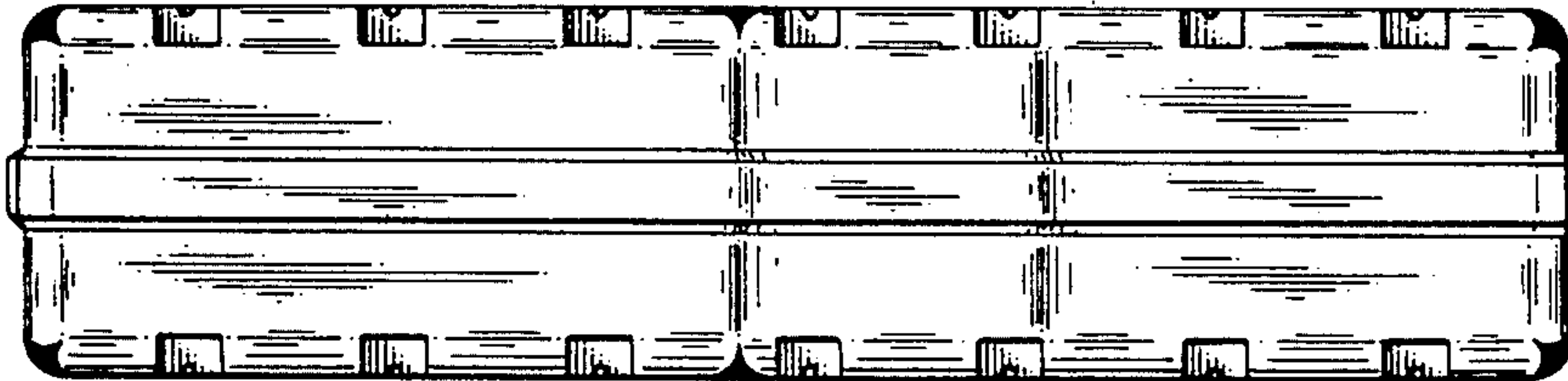

FIG. 5

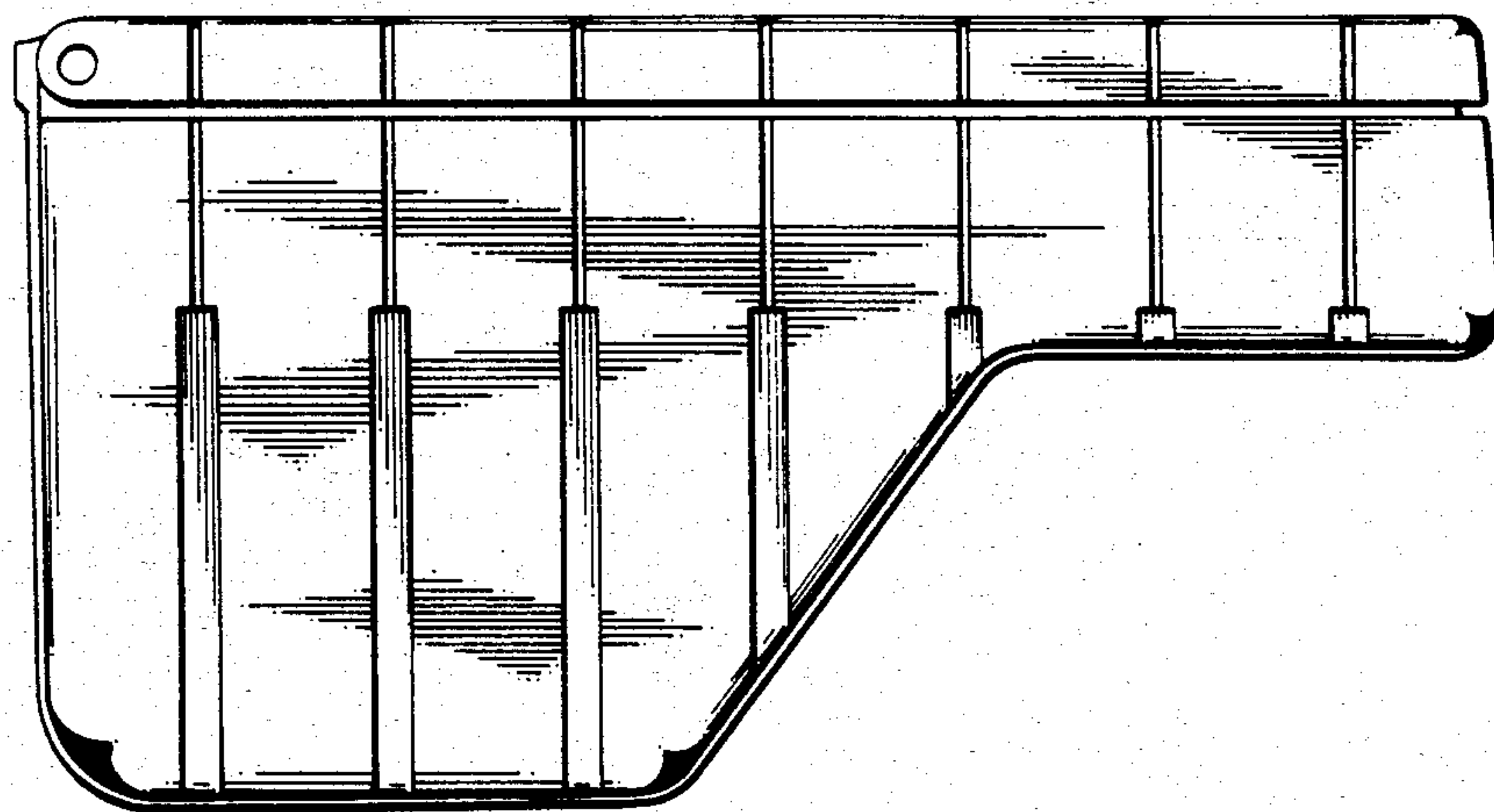

FIG. 6

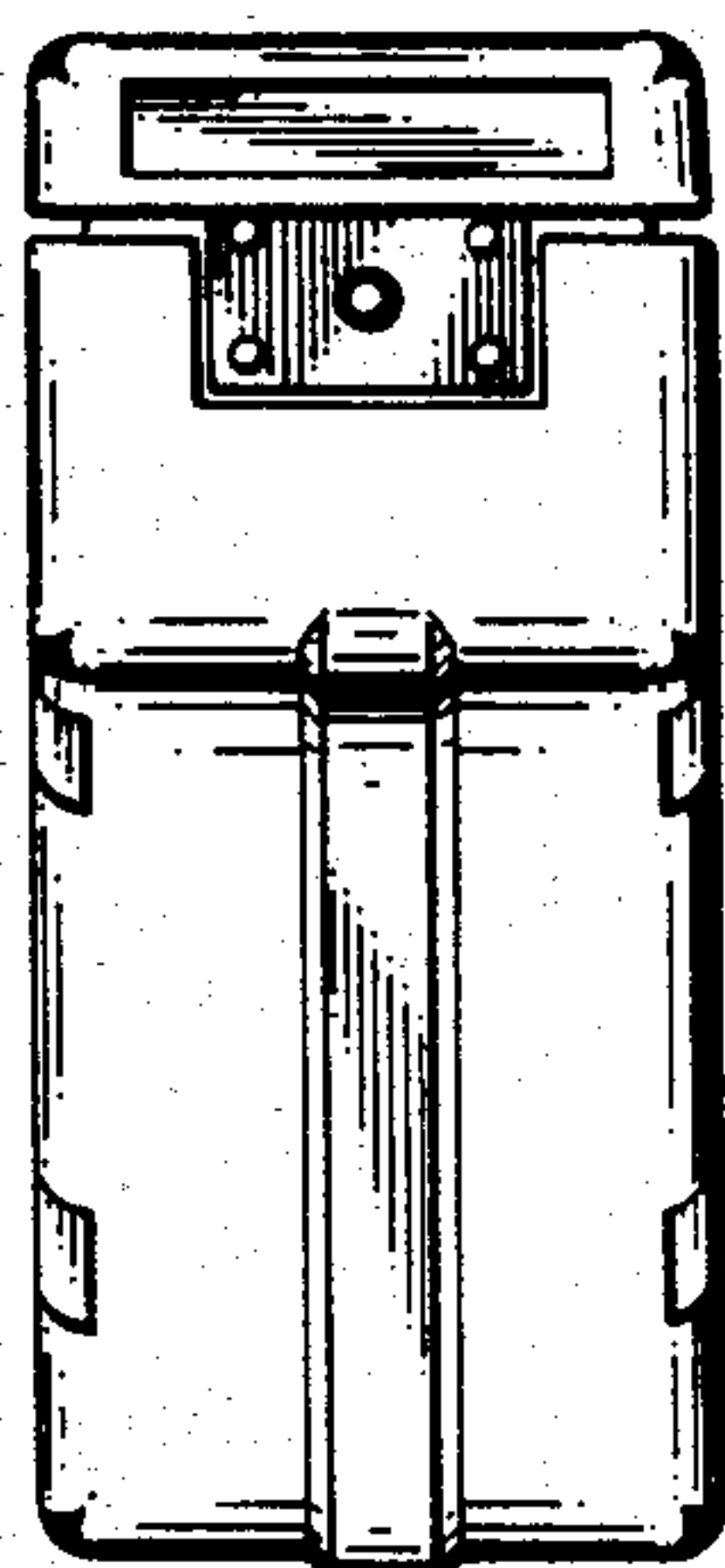

FIG. 7

