

[54] COMBINED HAIR BRUSH AND HAIR SPRAY DISPENSER

[76] Inventor: Mario Fini, 36 Park Hill Ter., Yonkers, N.Y. 10705

[**] Term: 14 Years

[21] Appl. No.: 548,946

[22] Filed: Nov. 7, 1983

[52] U.S. Cl. D9/300; D4/114; D4/116; D9/337; D9/338

[58] Field of Search D9/300, 337, 338; D4/114, 116, 127-133, 135, 138; 15/159 R, 160, 143 R, 106; 132/148; 401/137, 139, 192, 268, 28

[56] References Cited

U.S. PATENT DOCUMENTS

D. 251,826	5/1979	Hartung	D9/337
D. 264,181	5/1982	Booso	D9/337
D. 270,427	9/1983	Henington	D9/300
D. 271,179	11/1983	Smith	D9/338
886,996	5/1908	Loring	.	
1,405,077	1/1922	Tornansky	.	
1,714,556	5/1929	Grosser	.	
1,727,007	9/1929	Eyster	.	
2,770,826	11/1956	Curfman	401/139
2,828,500	4/1958	Peacock	.	

2,865,383	12/1958	Kaley	.	
3,011,499	12/1961	Tajan	401/139
3,406,694	10/1968	Odence	.	
3,516,424	6/1970	Eagle	.	
3,544,226	12/1970	Kellis	401/137 X
3,636,963	1/1972	Olson	.	
3,714,950	2/1973	Miska et al.	.	
3,960,160	6/1976	Hogan	.	

Primary Examiner—Catherine E. Kemper
Attorney, Agent, or Firm—Brooks, Haidt, Haffner & Delahunty

[57] CLAIM

The ornamental design for combined hair brush and hair spray dispenser, as shown and described.

DESCRIPTION

FIG. 1 is a perspective view of a combined hair brush and hair spray dispenser, showing my new design;
 FIG. 2 is a side elevational view thereof;
 FIG. 3 is a top plan view thereof;
 FIG. 4 is a bottom plan view thereof;
 FIG. 5 is an end elevational view thereof;
 FIG. 6 is an elevational view of the opposite end thereof.
 The pattern of bristle tufts which is fragmentarily shown in FIG. 4 is understood to repeat uniformly and continuously across the entire area indicated.

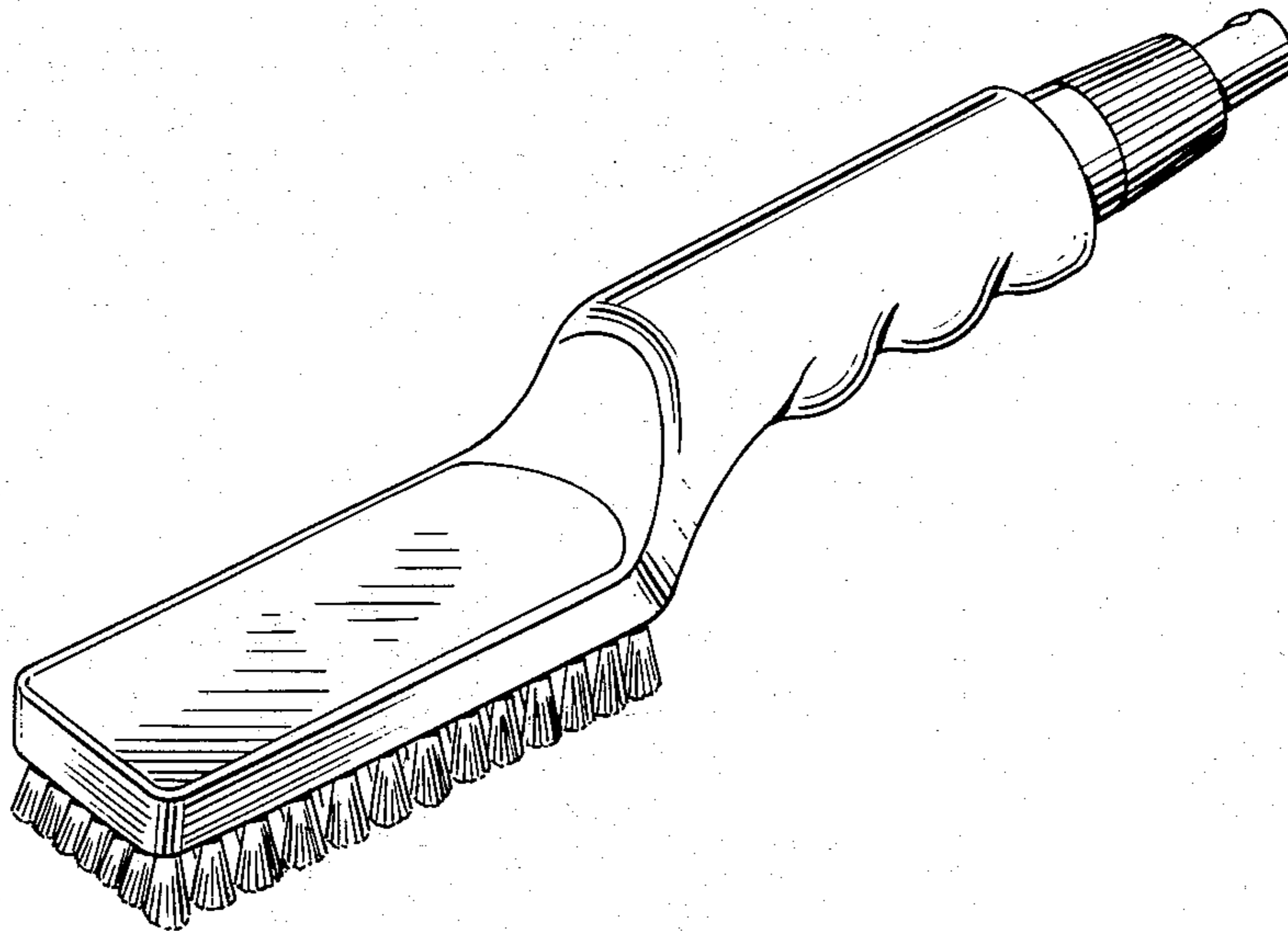

Fig. 2.

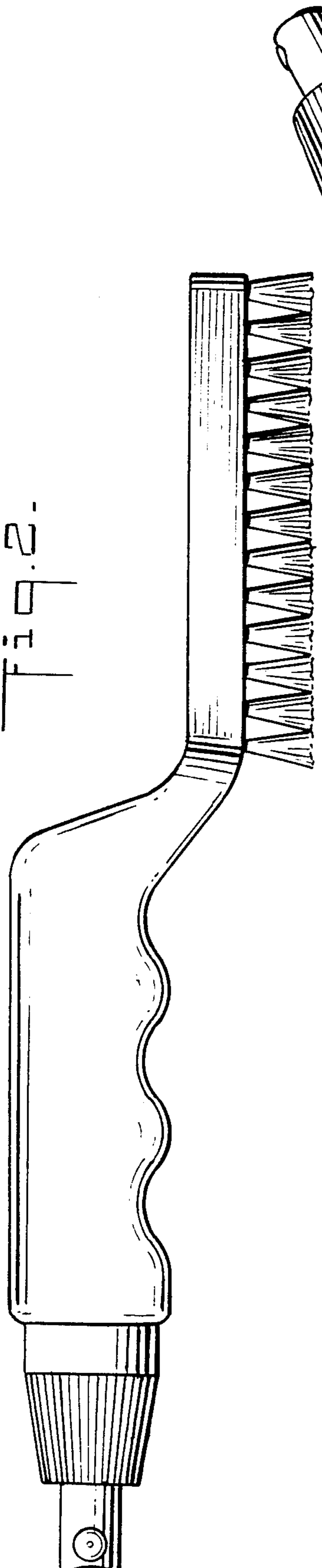

Fig. 6.

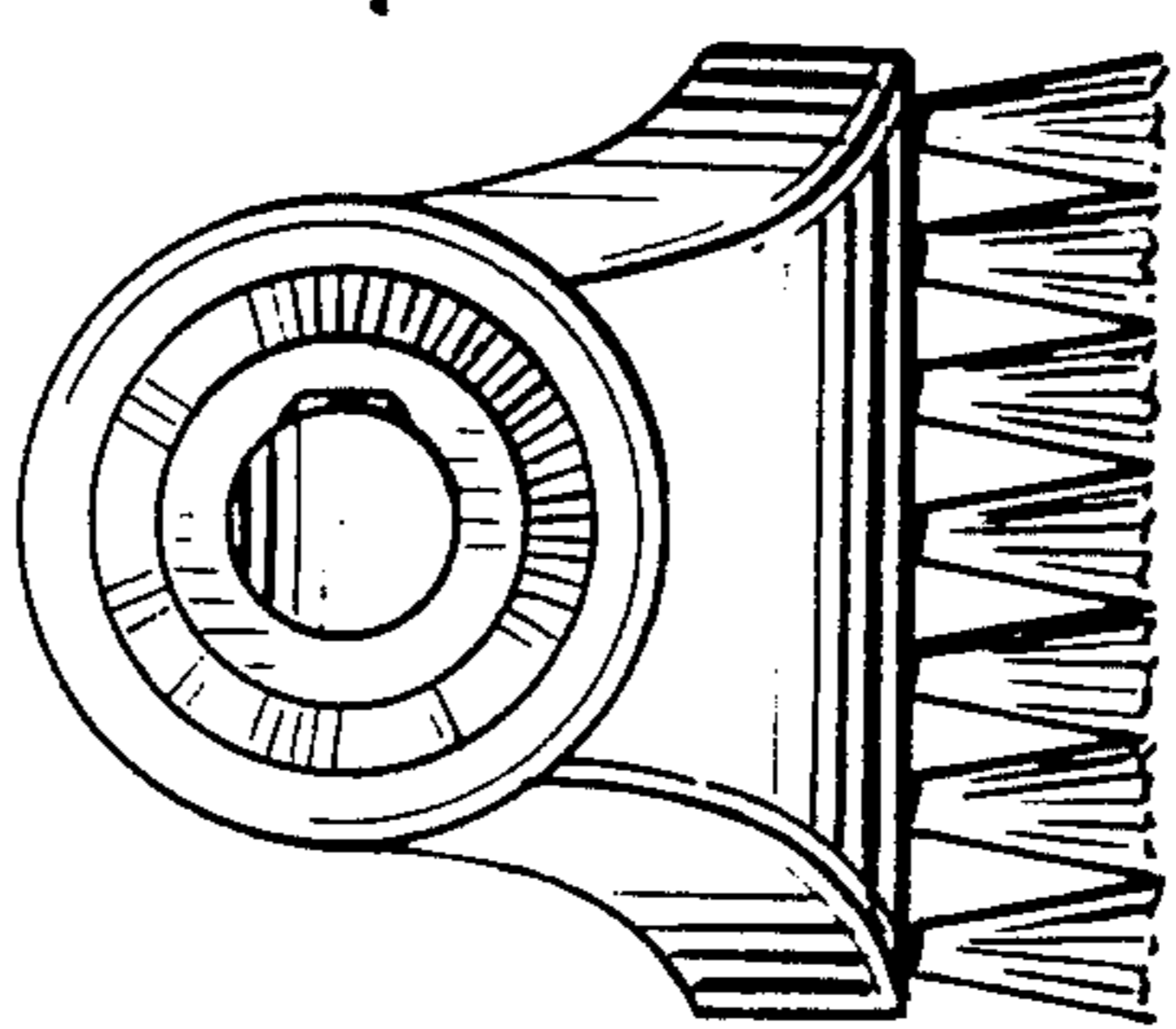
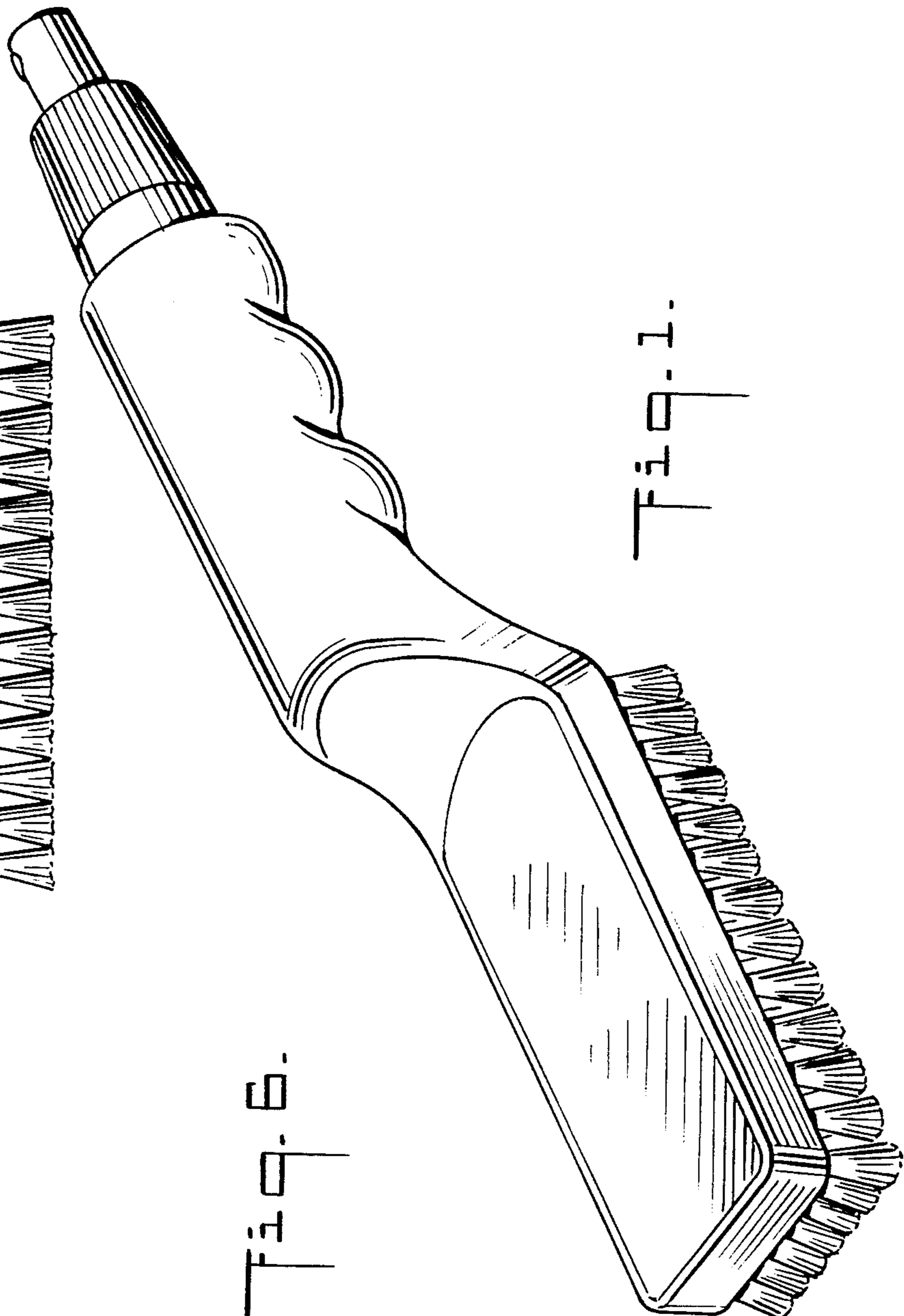

Fig. 1.



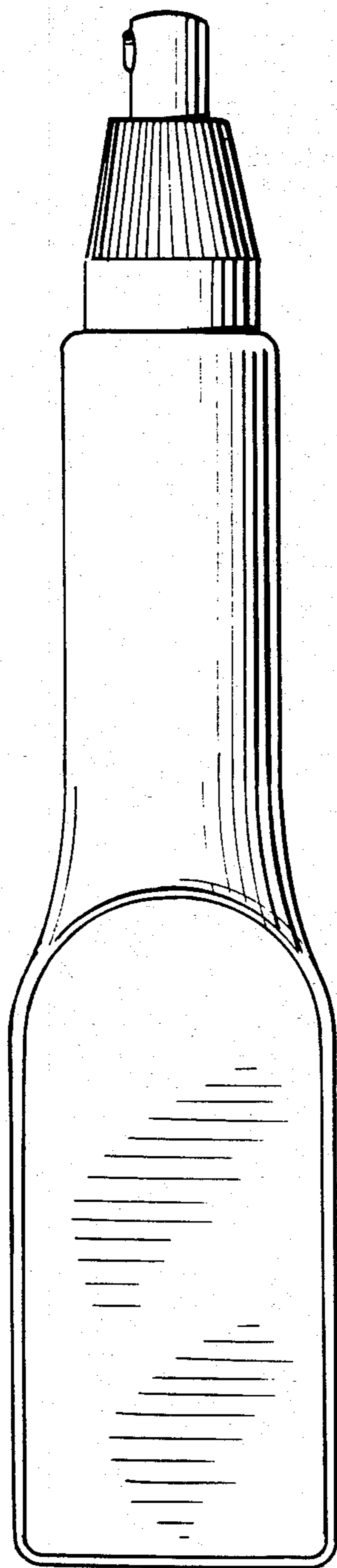

Fig. 3.

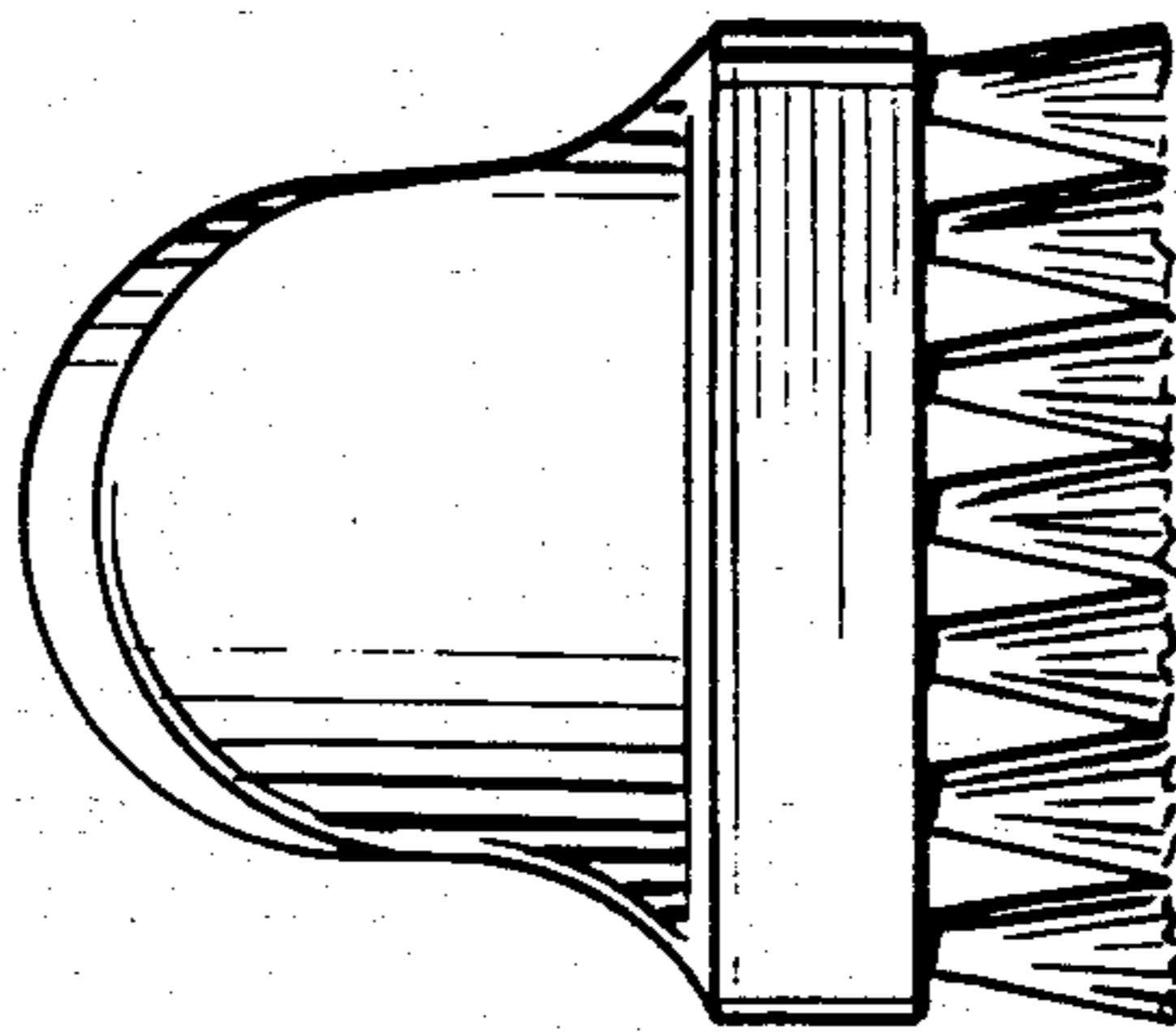

Fig. 5.

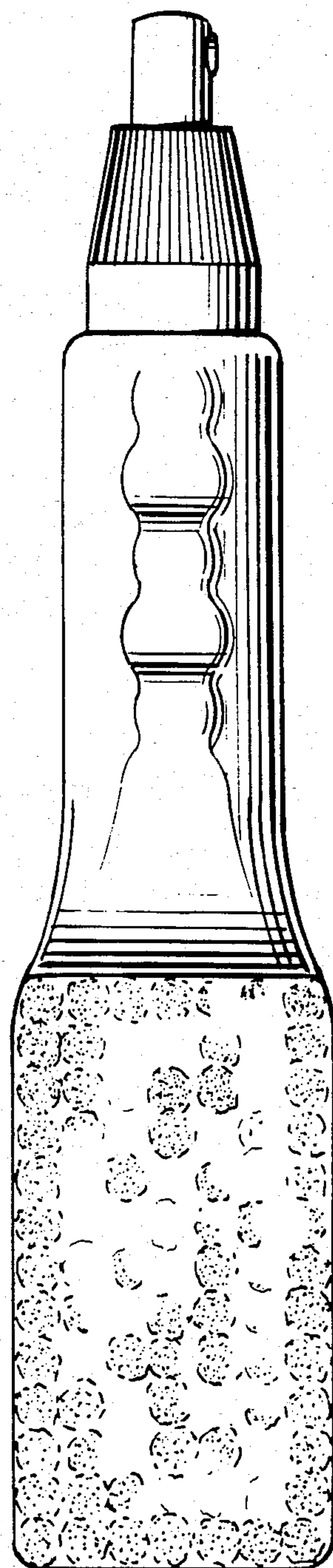

Fig. 4.