

[54] COMBINED DISPLAY CASE FISH TANK

[76] Inventor: Andrew Balducci, 7 Todd Ct., East Williston, N.Y.

[\*\*] Term: 14 Years

[21] Appl. No.: 460,195

[22] Filed: Jan. 24, 1983

[52] U.S. Cl. .... D30/11; D6/477

[58] Field of Search ..... D30/6-12; D6/470-473; 312/114, 117; 119/5

D. 268,069 3/1983 Milstein ..... D6/472  
 3,324,829 6/1967 de Jose et al. .... 119/5

Primary Examiner—James R. Largen  
 Attorney, Agent, or Firm—Howard C. Miskin

[57] CLAIM

The ornamental design for a combined display case and fish tank, as shown and described.

DESCRIPTION

FIG. 1 is a perspective view taken from the top, front and left side of a combined display case and fish tank showing my new design;

FIG. 2 is a perspective view taken from the top, rear and left side thereof;

FIG. 3 is a front elevational view thereof;

FIG. 4 is a rear elevational view thereof;

FIG. 5 is a top plan view thereof;

FIG. 6 is a bottom plan view thereof;

FIG. 7 is a right side elevational view thereof; and

FIG. 8 is a cross sectional view taken on line 8—8 of FIG. 3.

[56] References Cited  
 U.S. PATENT DOCUMENTS

D. 16,987	11/1886	Mullan	.....	D6/471
D. 111,867	10/1938	Tyler	.....	D6/472
D. 119,509	3/1940	Waddell	.....	D6/472
D. 152,456	1/1949	Buxbaum et al.	.....	D30/11
D. 196,107	8/1963	Schor et al.	.....	D30/11
D. 198,844	8/1964	Graham	.....	D30/11 X
D. 212,481	10/1968	Hiland	.....	D30/11
D. 246,262	11/1977	Zupo	.....	D30/8

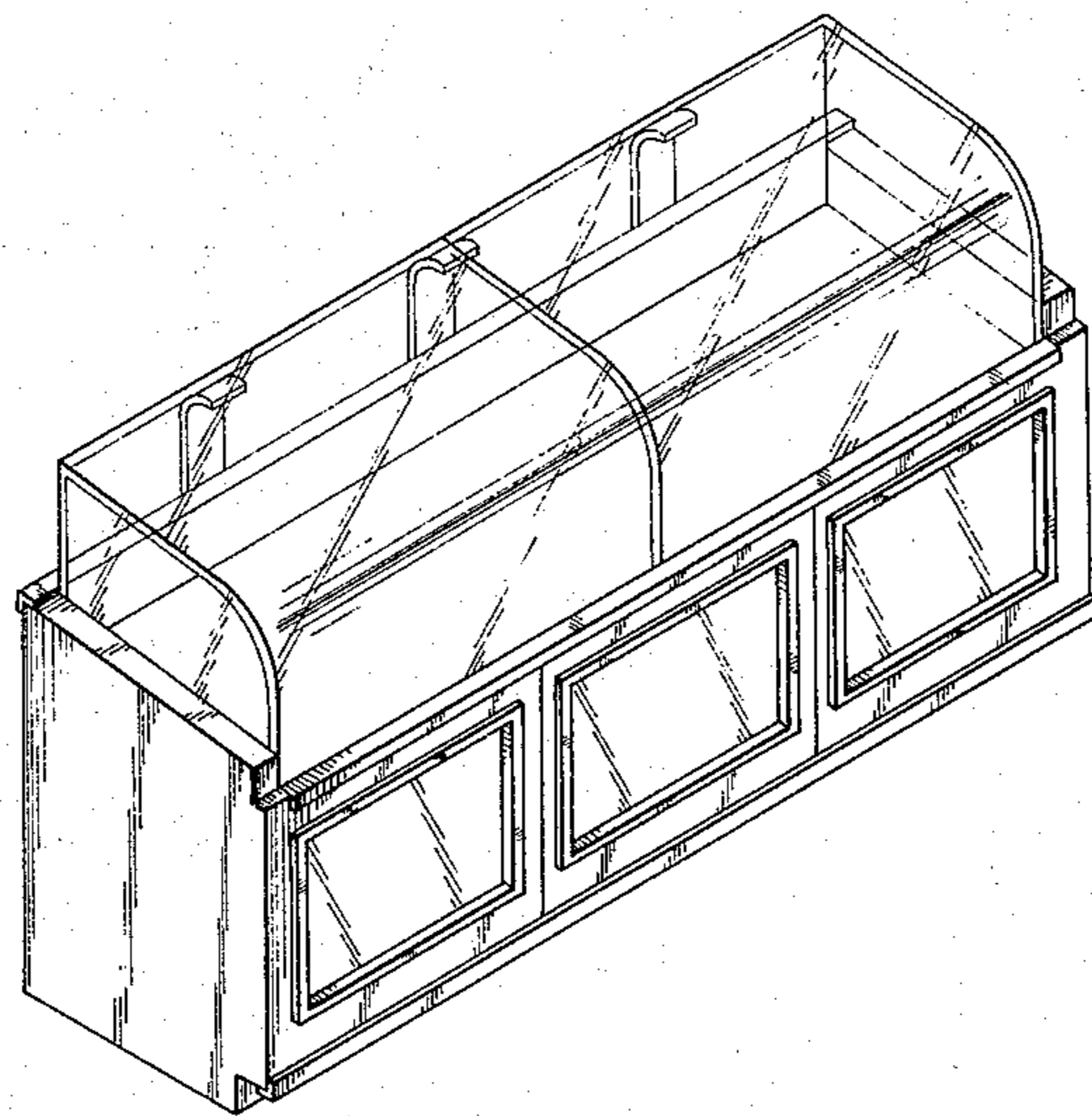

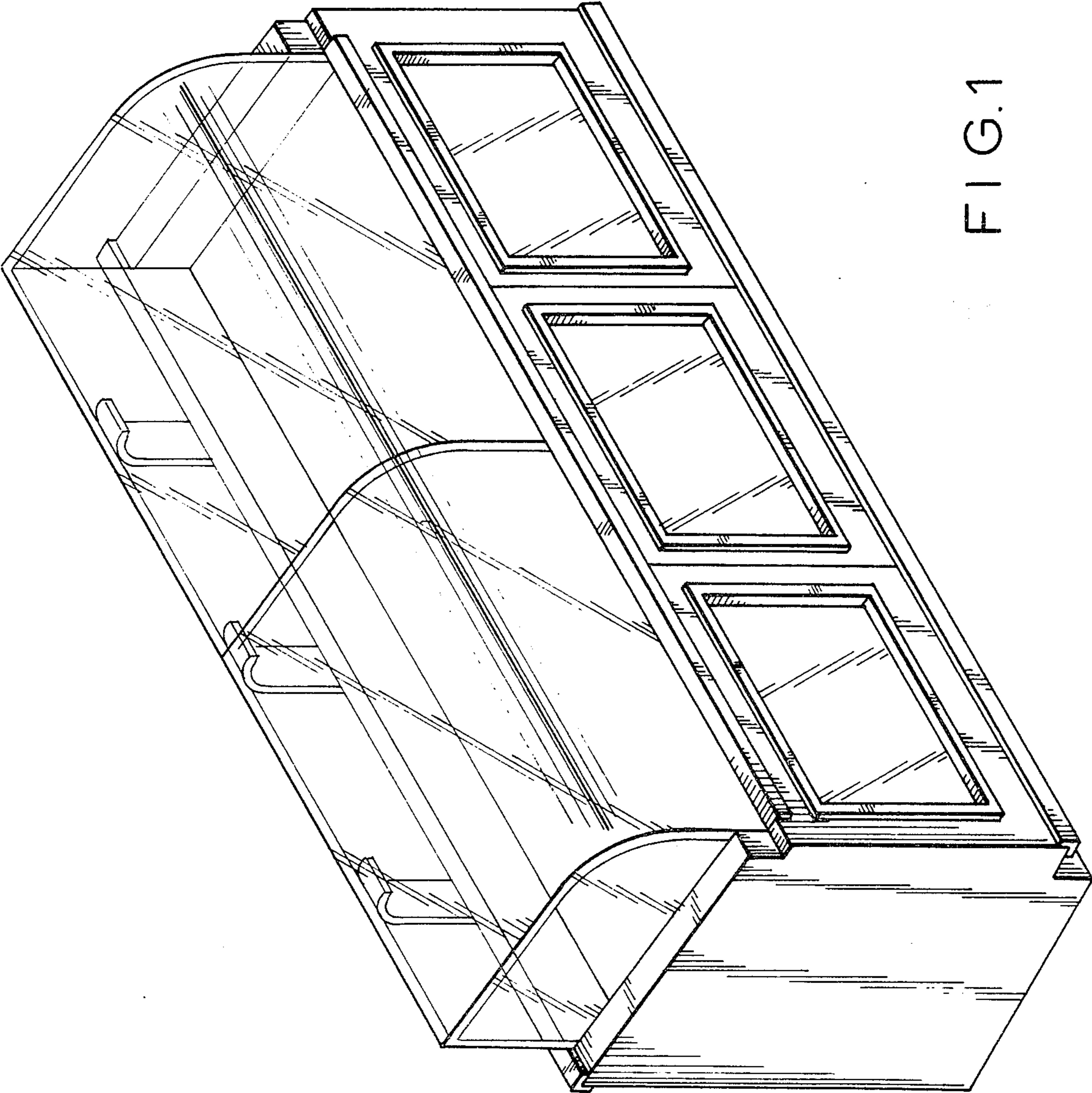

FIG. 1



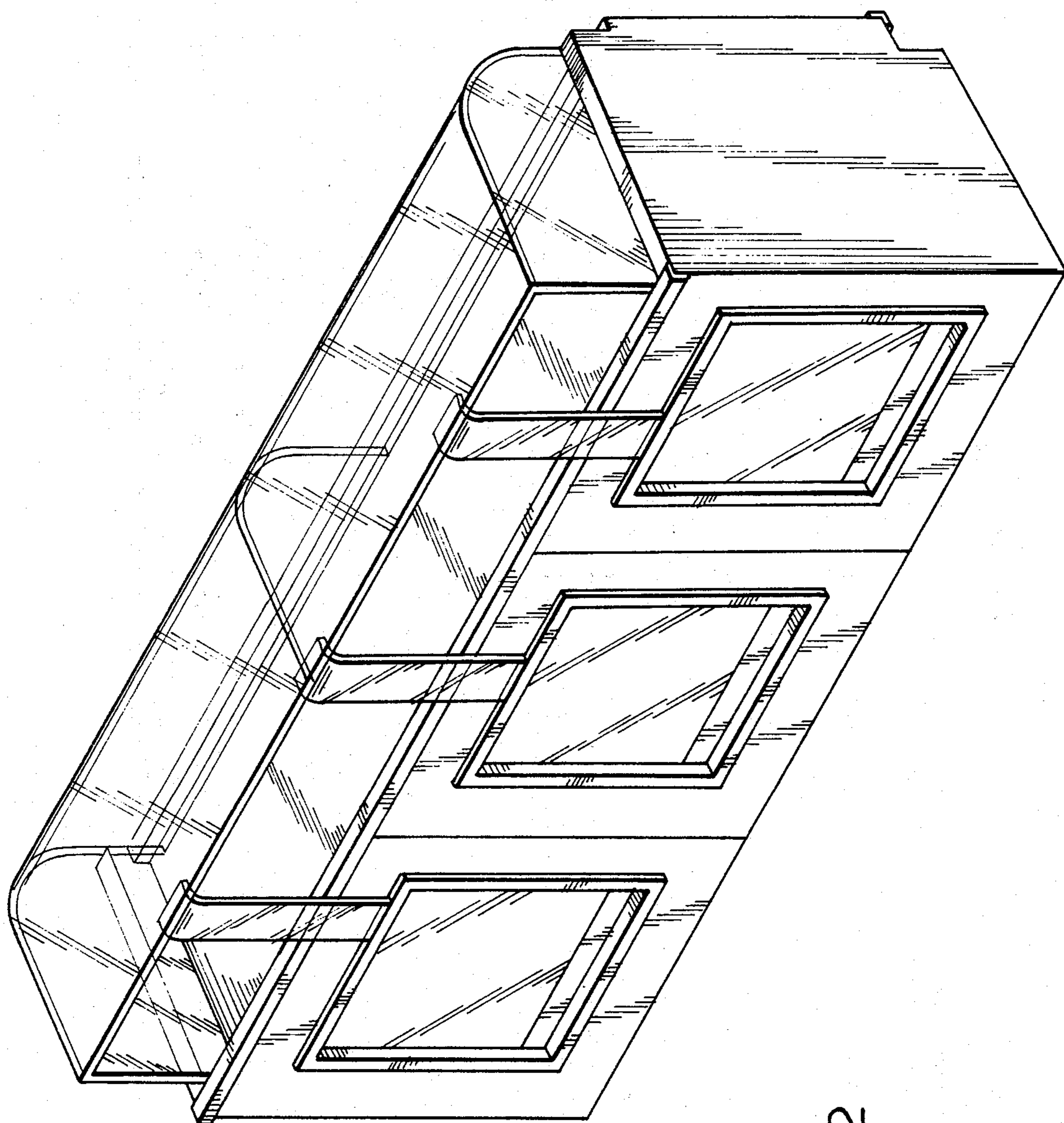

FIG. 2

FIG. 3

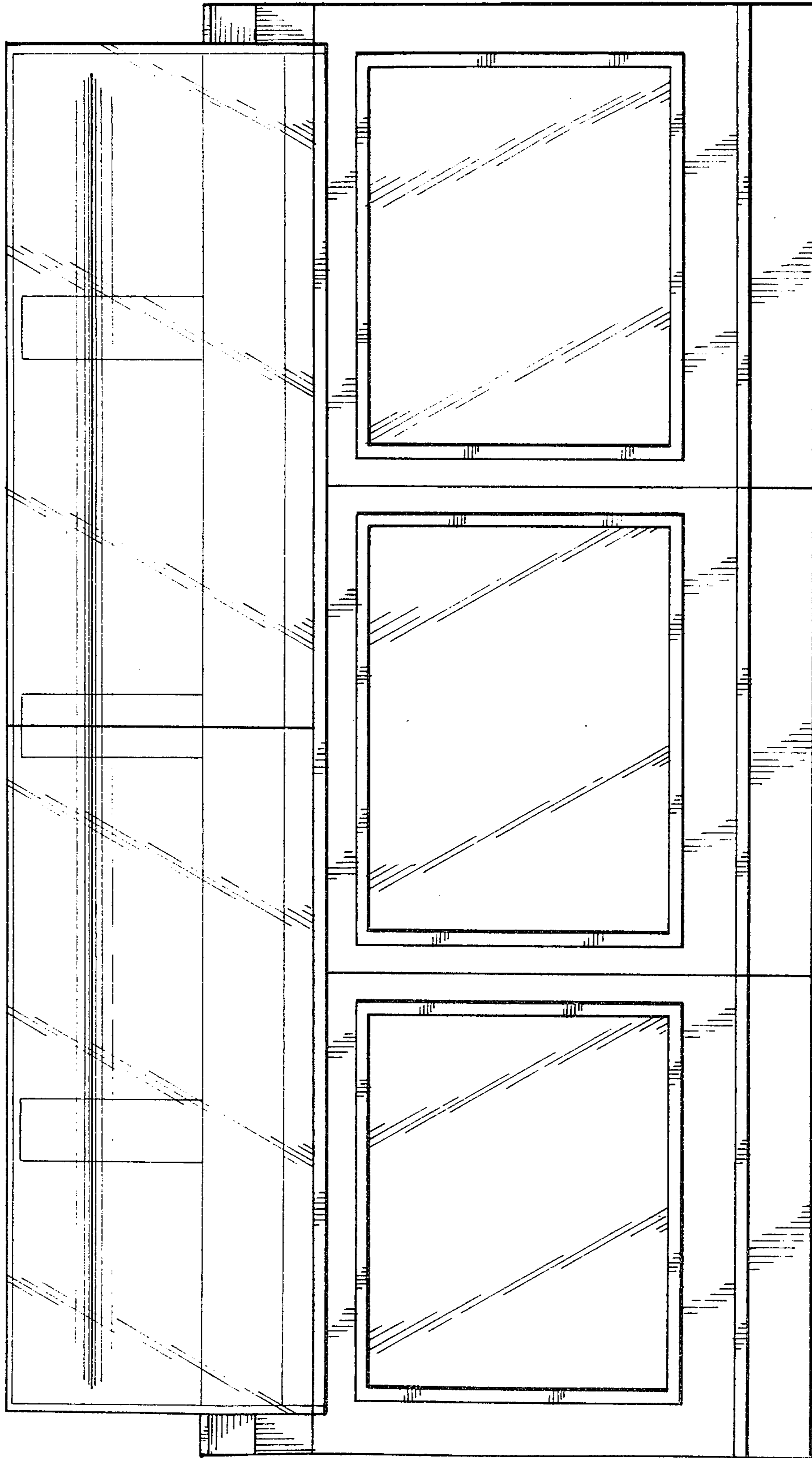

FIG. 4

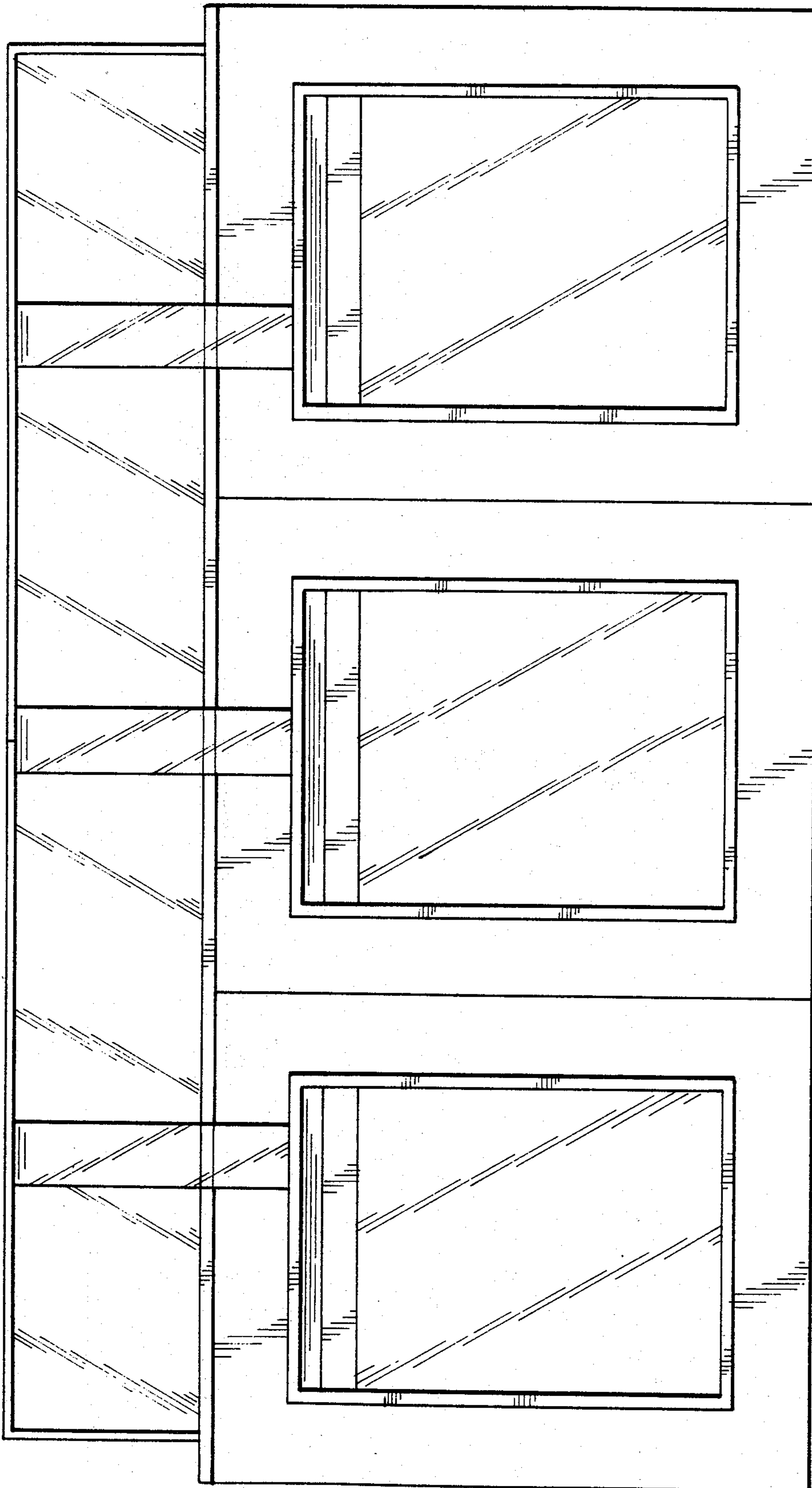

FIG. 5

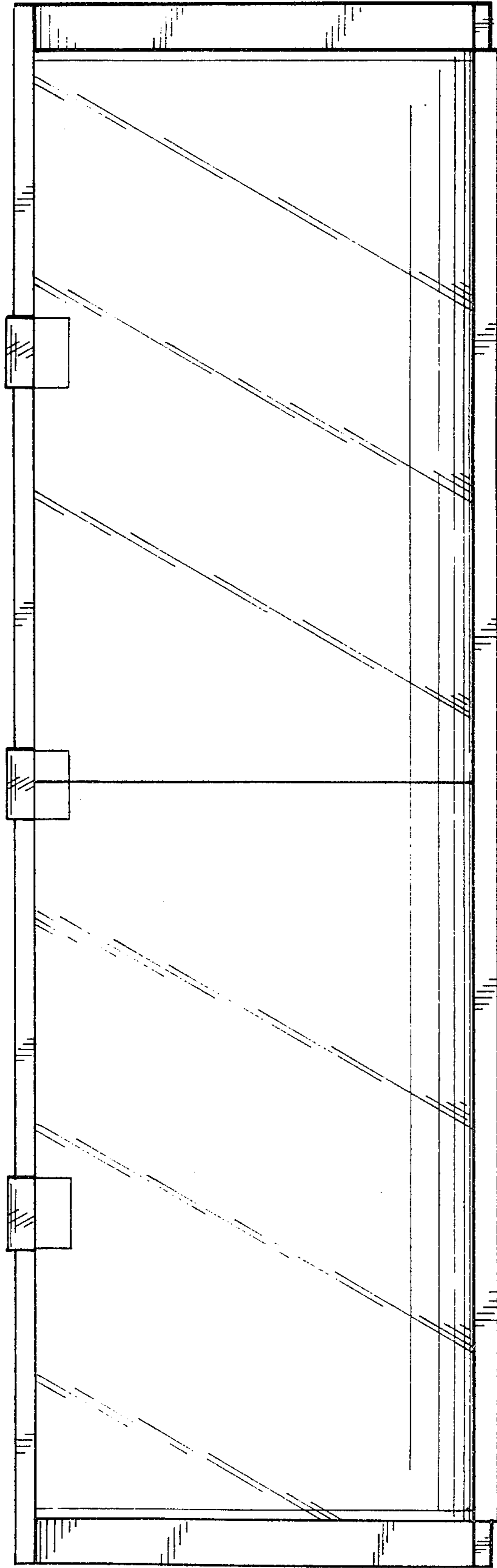



FIG. 6

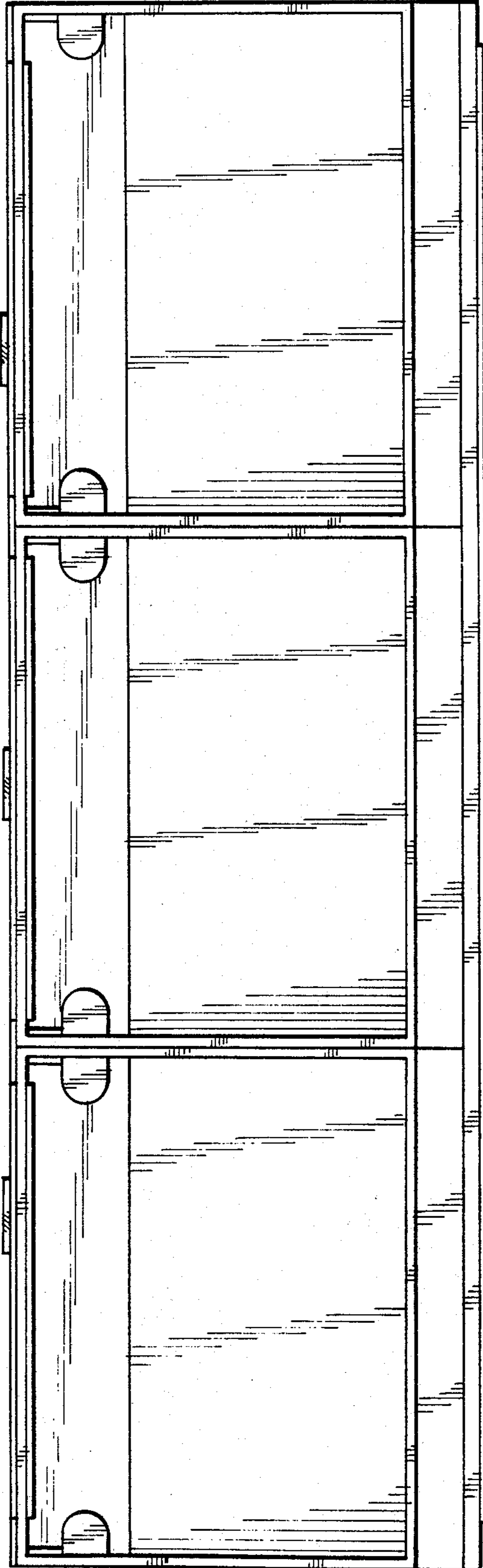

FIG. 7

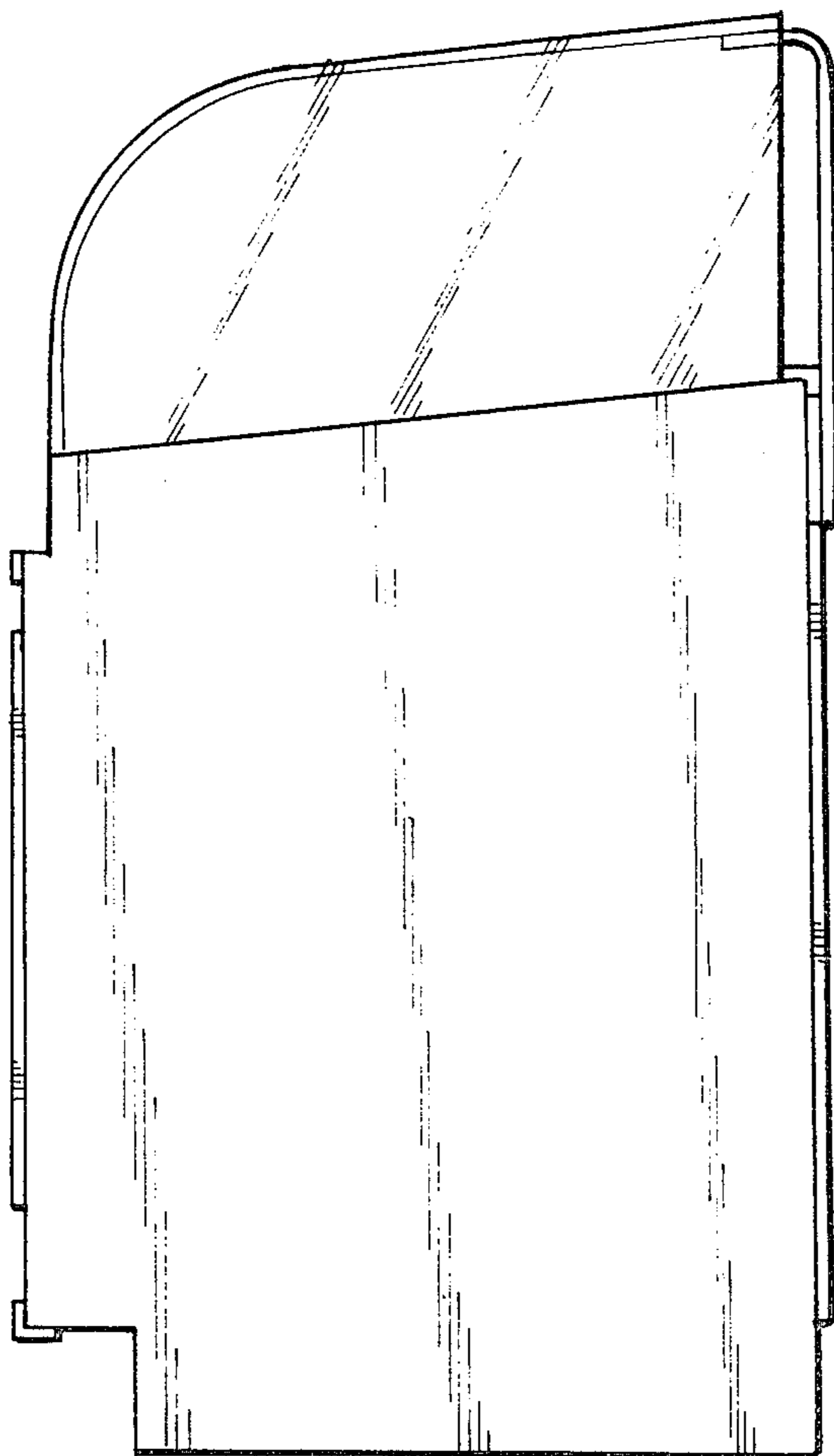



FIG. 8

