

# United States Patent [19]

Abe et al.

[11] Patent Number: **Des. 279,411**

[45] Date of Patent: **\*\* Jun. 25, 1985**

[54] **ELECTRIC HAIR CLIPPER**

D. 268,616 4/1983 Ullmann ..... D28/49

[75] Inventors: **Noboru Abe, Suita, Japan; Florian Seiffert, Gründwald, Fed. Rep. of Germany**

[73] Assignee: **Matsushita Electric Works, Ltd., Osaka, Japan**

[\*\*] Term: **14 Years**

[21] Appl. No.: **488,766**

[22] Filed: **Apr. 26, 1983**

[30] **Foreign Application Priority Data**

Dec. 20, 1982 [JP] Japan ..... 57-57028

[52] U.S. Cl. .... **D28/53**

[58] Field of Search ..... D28/44-54;  
30/32, 34 R, 34.1, 41.9, 43, 43.7-43.92, 86, 90,  
200, 201, 210, 220

[56] **References Cited**

**U.S. PATENT DOCUMENTS**

D. 232,329 8/1974 Madl ..... D28/53

**OTHER PUBLICATIONS**

*HFD-Retailing Home Furnishings*, 7/14/80, p. 13, section three-Sanyo Hair Trimmer at left.

*Primary Examiner*—Louis S. Zarfes  
*Attorney, Agent, or Firm*—Burns, Doane, Swecker & Mathis

[57] **CLAIM**

The ornamental design for an electric hair clipper, substantially as shown and described.

**DESCRIPTION**

FIG. 1 is a front elevational view of an electric hair clipper showing our new design;  
FIG. 2 is a rear elevational view thereof;  
FIG. 3 is a top plan view thereof;  
FIG. 4 is a bottom plan view thereof;  
FIG. 5 is a left side elevational view thereof;  
FIG. 6 is a right side elevational view thereof;  
FIG. 7 is a sectional view taken on line VII—VII in FIG. 1; and  
FIG. 8 is a perspective view thereof.

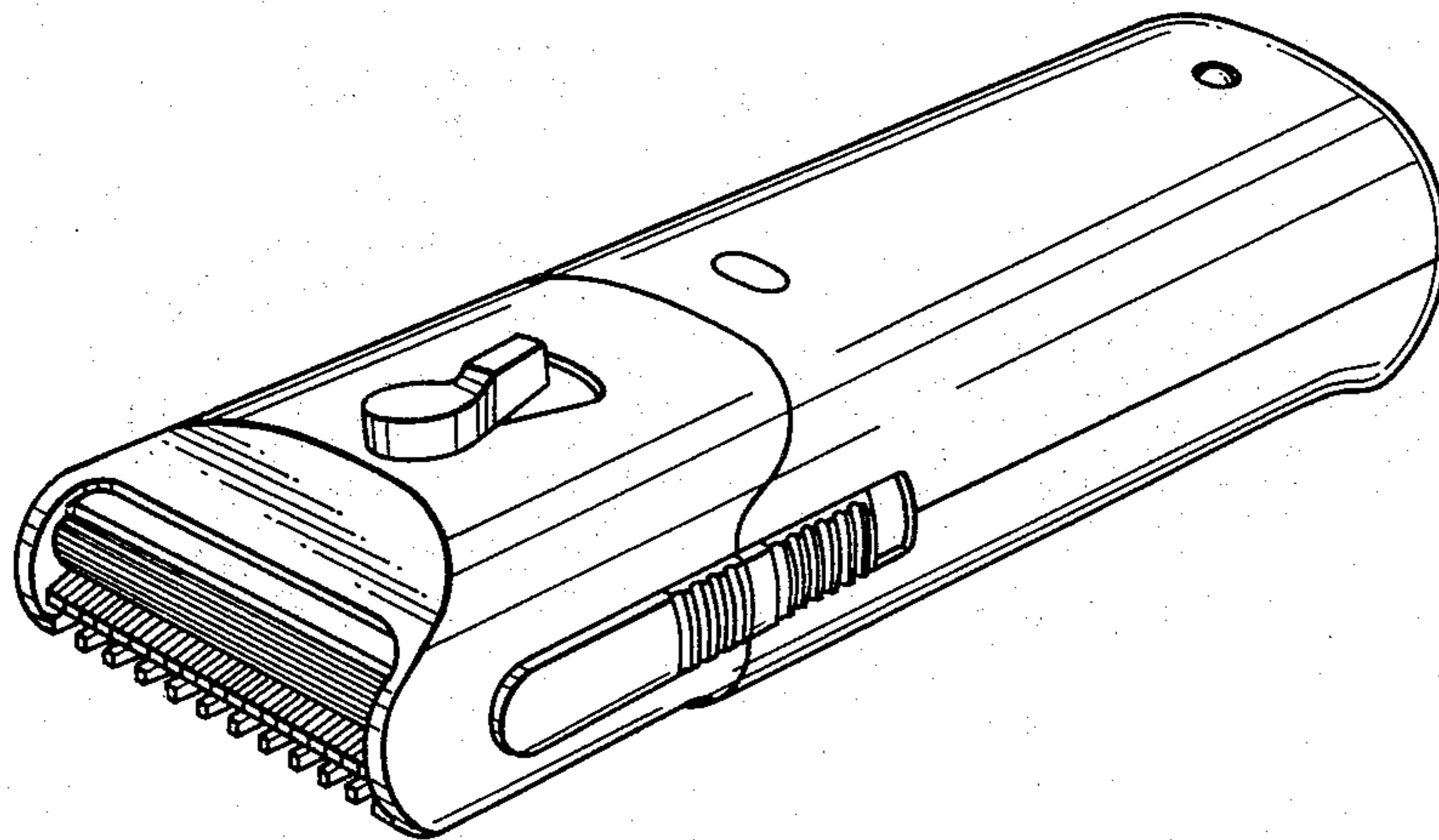

*Fig. 1*

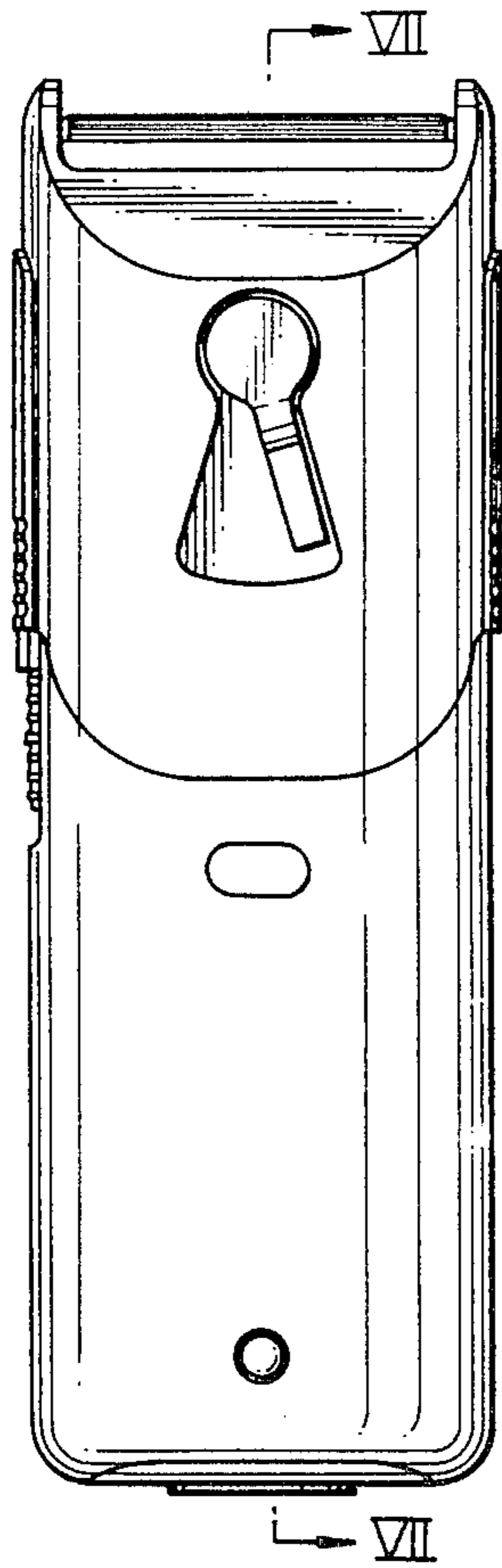

*Fig. 2*

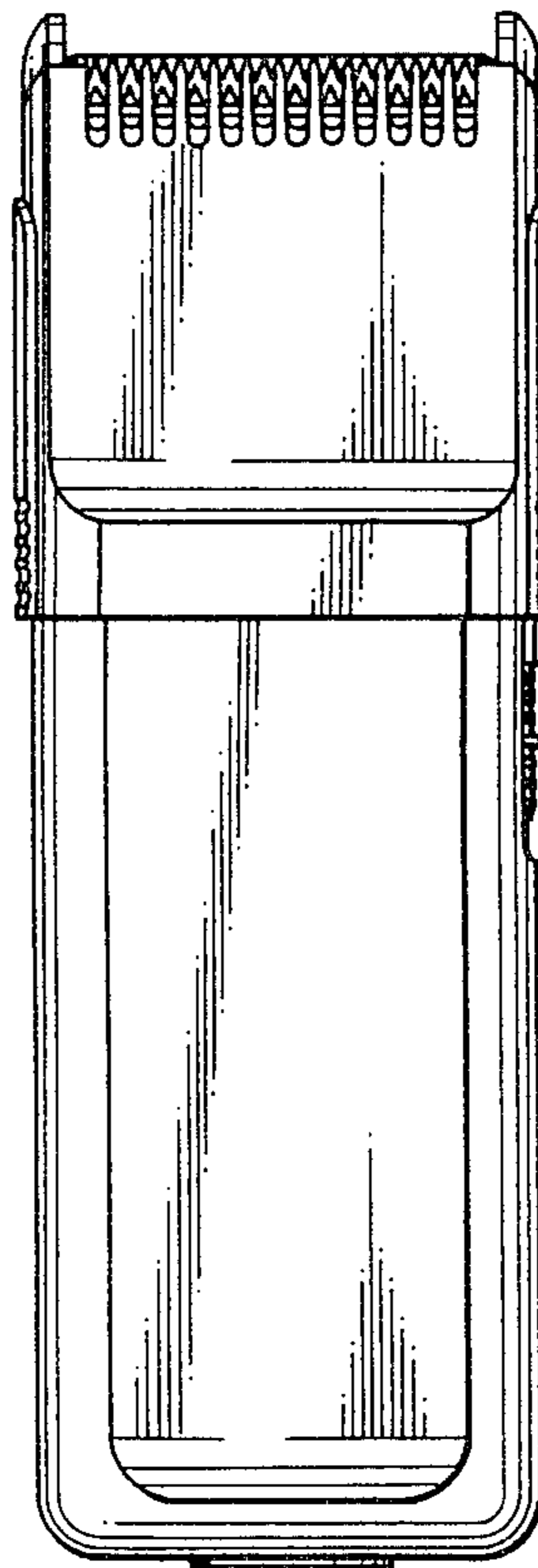

*Fig. 3*

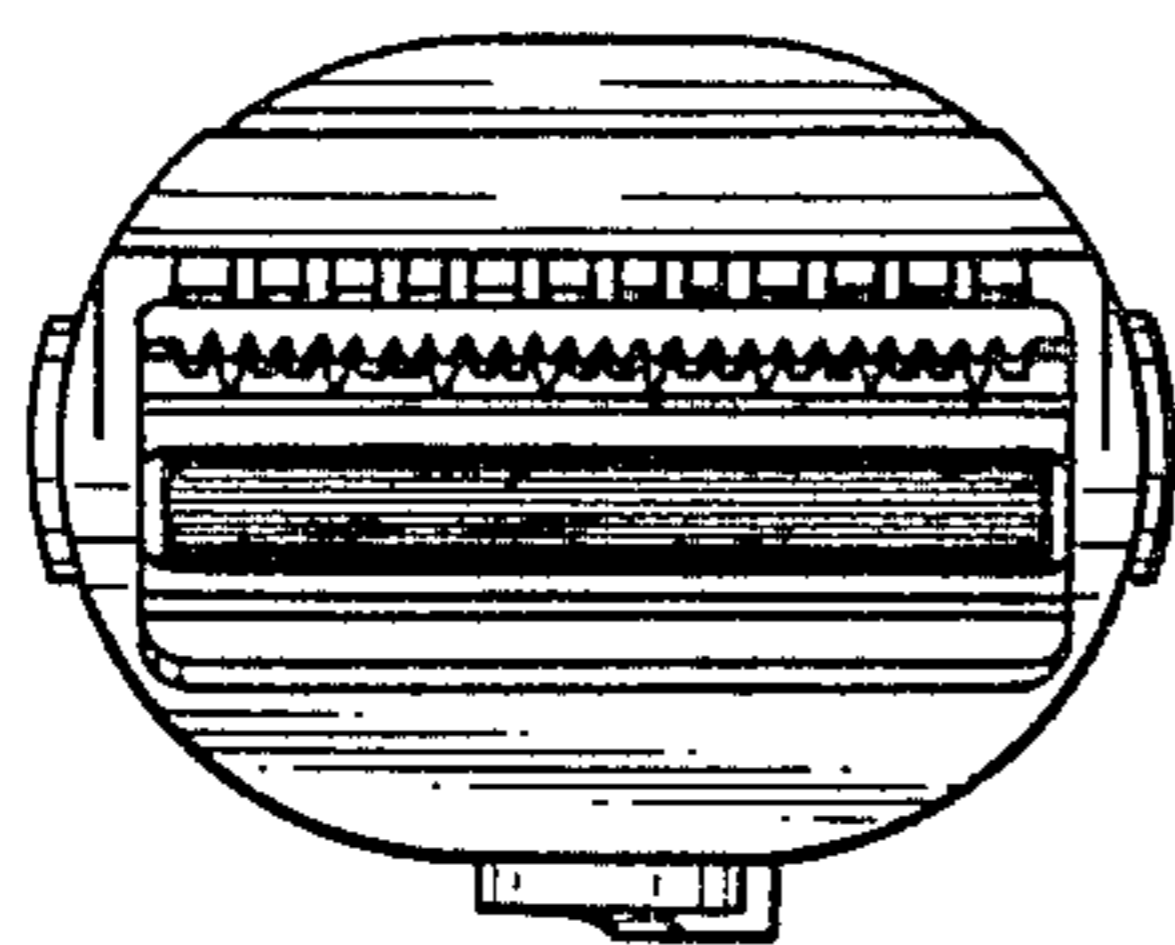

*Fig. 4*

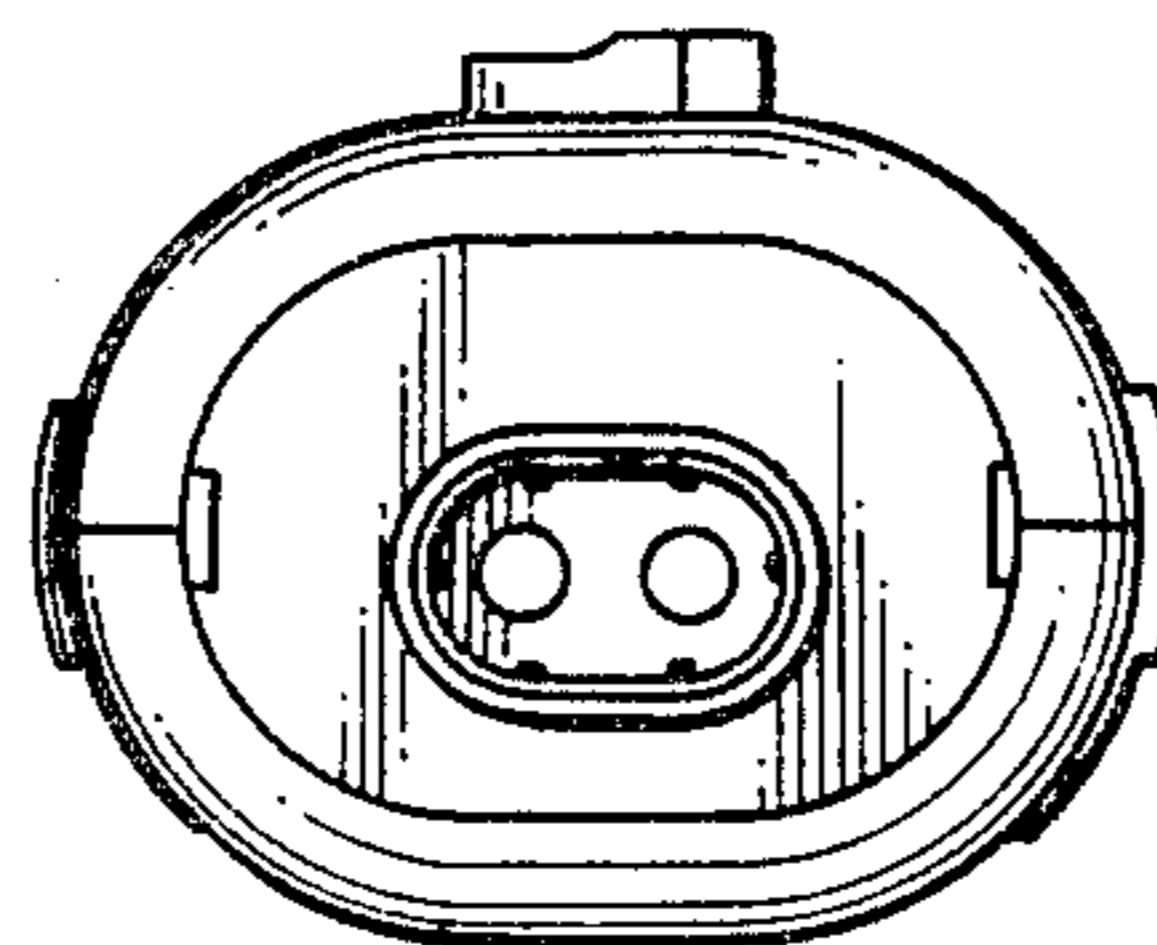

*Fig. 5*

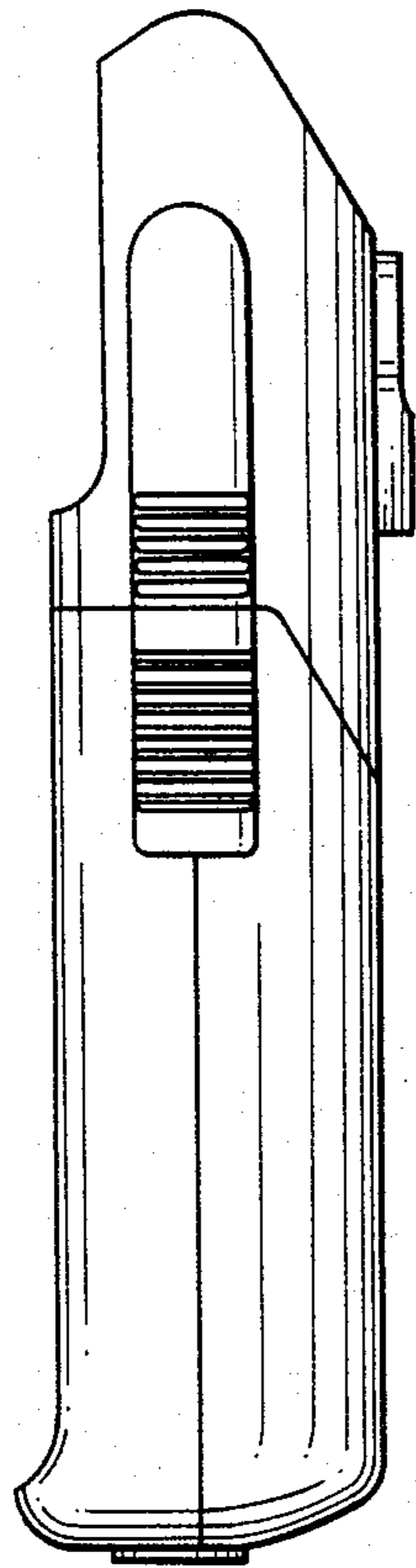

*Fig. 6*

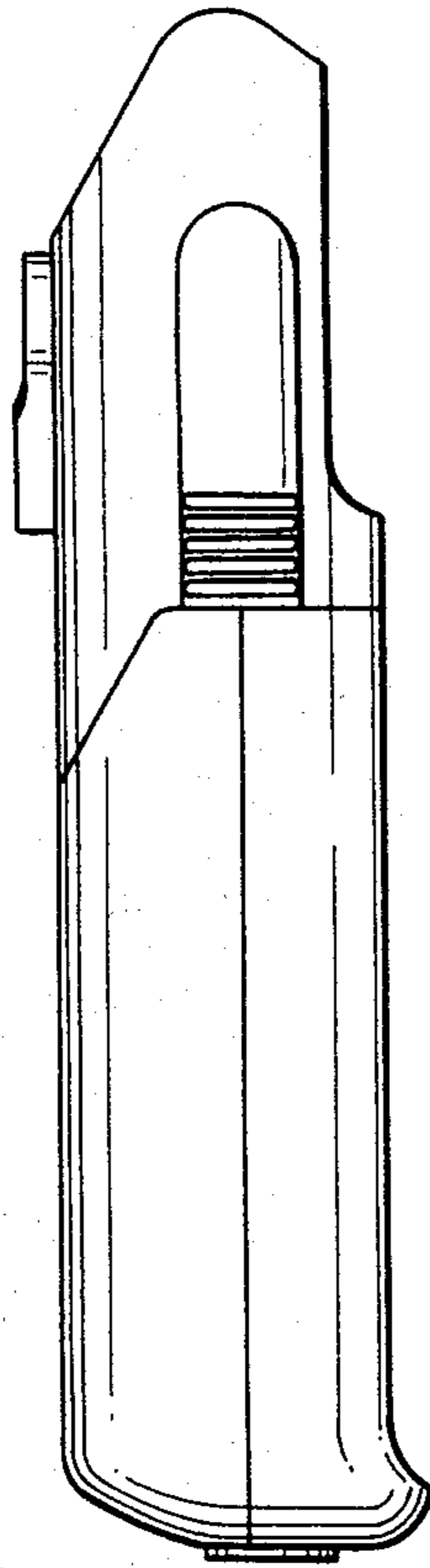

*Fig. 7*

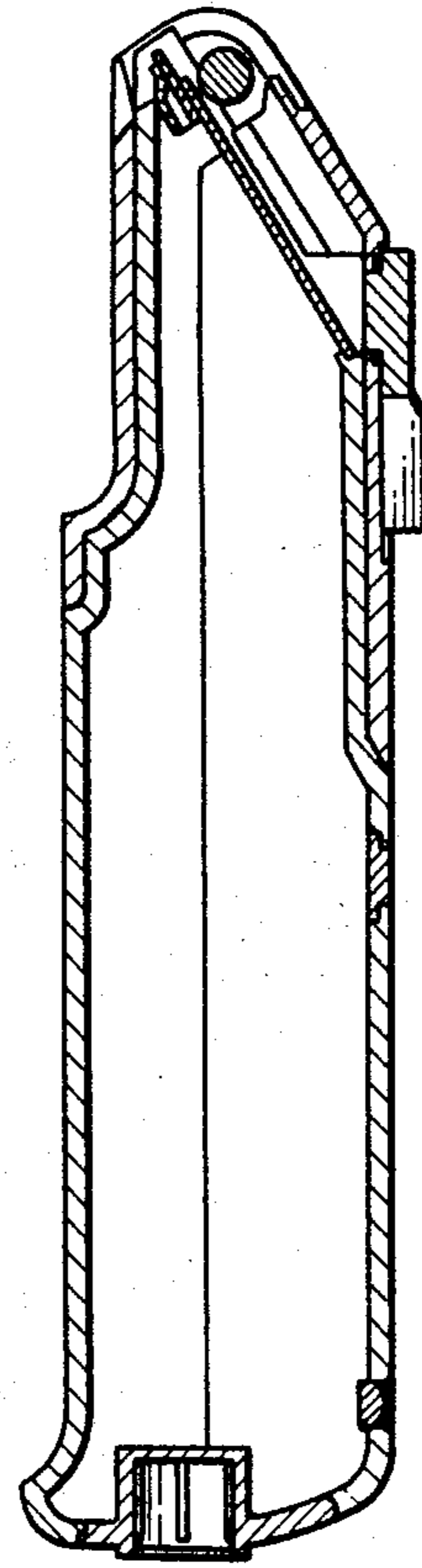

*Fig. 8*

