

United States Patent [19]
Griffith

[11] **Patent Number: Des. 279,331**

[45] **Date of Patent: ** Jun. 25, 1985**

[54] **CHAIR**

[76] **Inventor: Jeremy N. Griffith, Clothiers Creek Rd., Condong, Via Murwillumbah, New South Wales, Australia, 2484**

[**] **Term: 14 Years**

[21] **Appl. No.: 383,933**

[22] **Filed: Jun. 1, 1982**

[30] **Foreign Application Priority Data**

Mar. 2, 1982 [AU] Australia 86647
[52] **U.S. Cl. D6/379**
[58] **Field of Search D6/47-78**

[56] **References Cited**

U.S. PATENT DOCUMENTS

D. 245,739 9/1977 Cook, Jr. D6/73 X

OTHER PUBLICATIONS

Scandiline Brochure, p. 521, Chair No. 576-24.

Primary Examiner—Bruce W. Dunkins
Attorney, Agent, or Firm—Stevens, Davis, Miller & Mosher

[57] **CLAIM**

The ornamental design for a chair, as shown.

DESCRIPTION

FIG. 1 is a side elevation of a chair showing my design;
FIG. 2 is a front elevation;
FIG. 3 is a rear elevation;
FIG. 4 is a plan view from below;
FIG. 5 is a plan view from above; and
FIG. 6 is a perspective view.

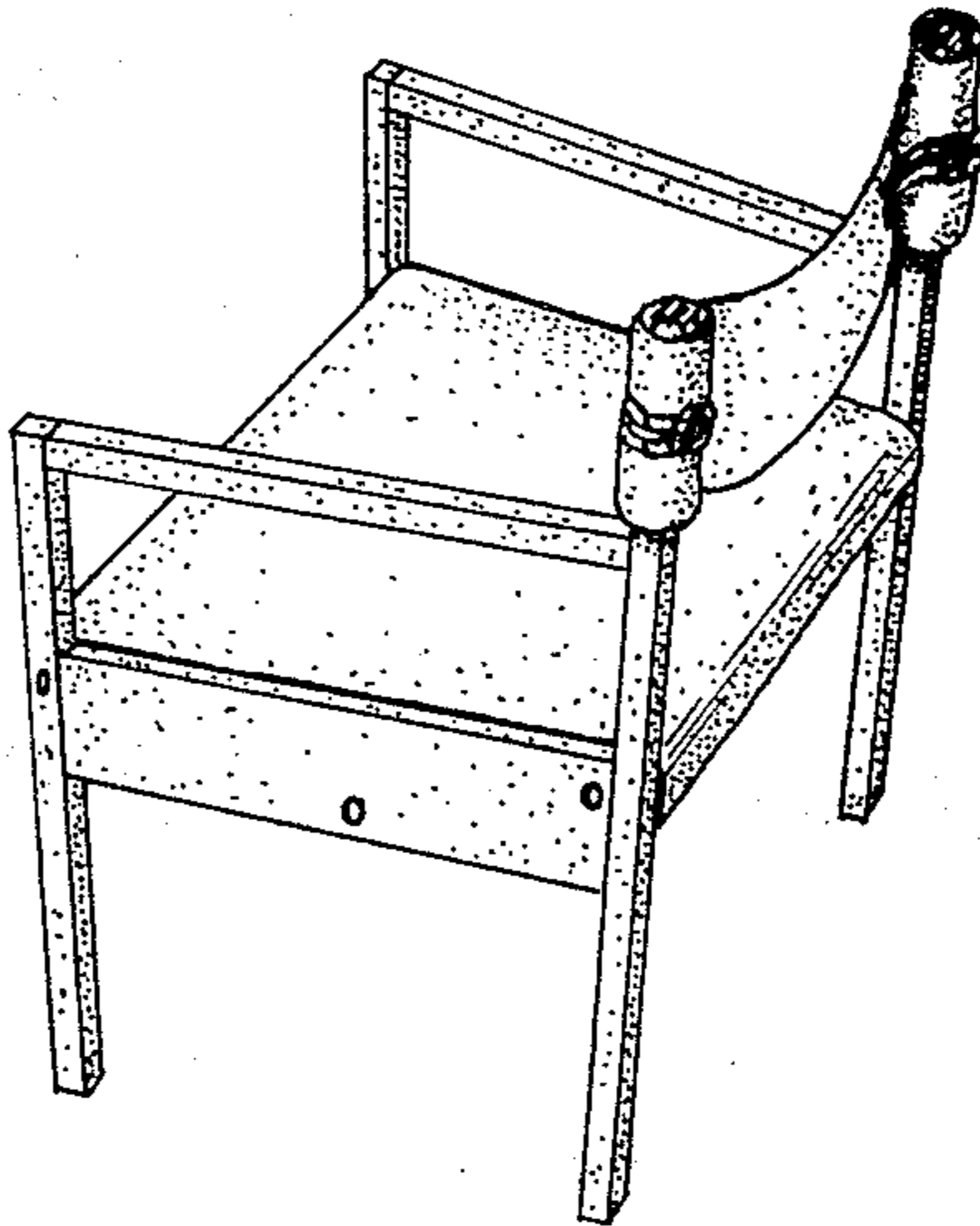

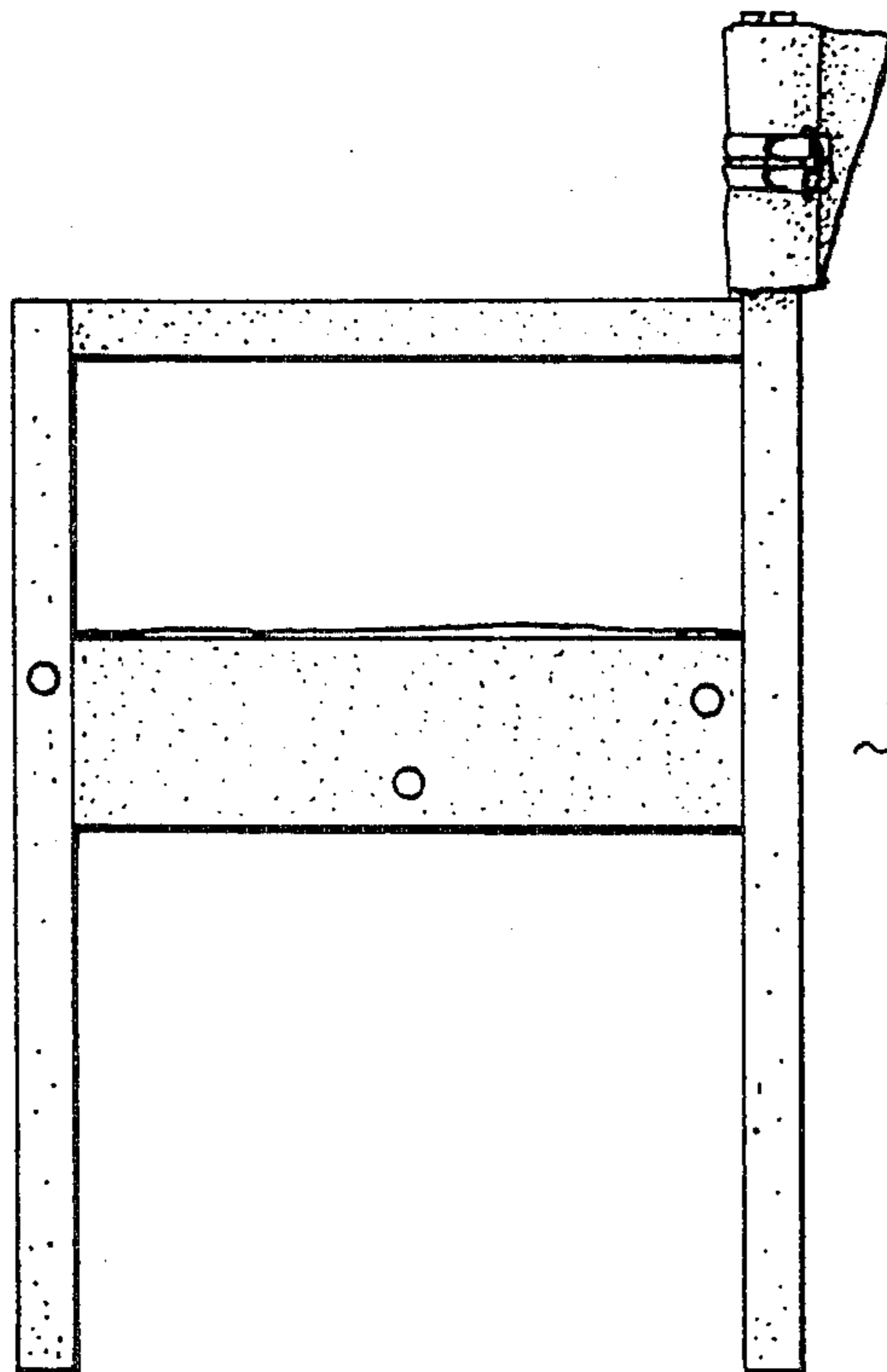

~Fig. 1~

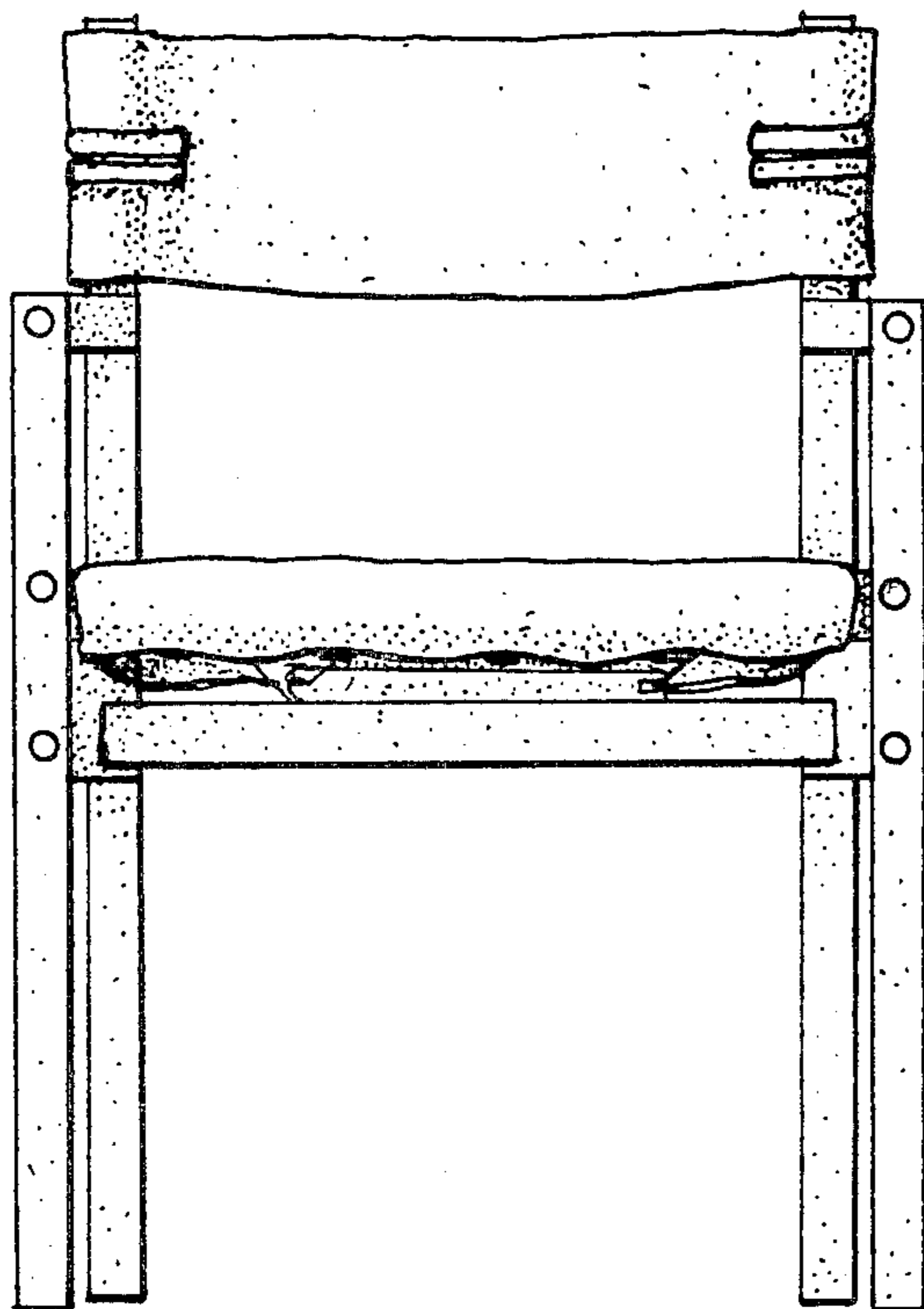

~Fig. 2~

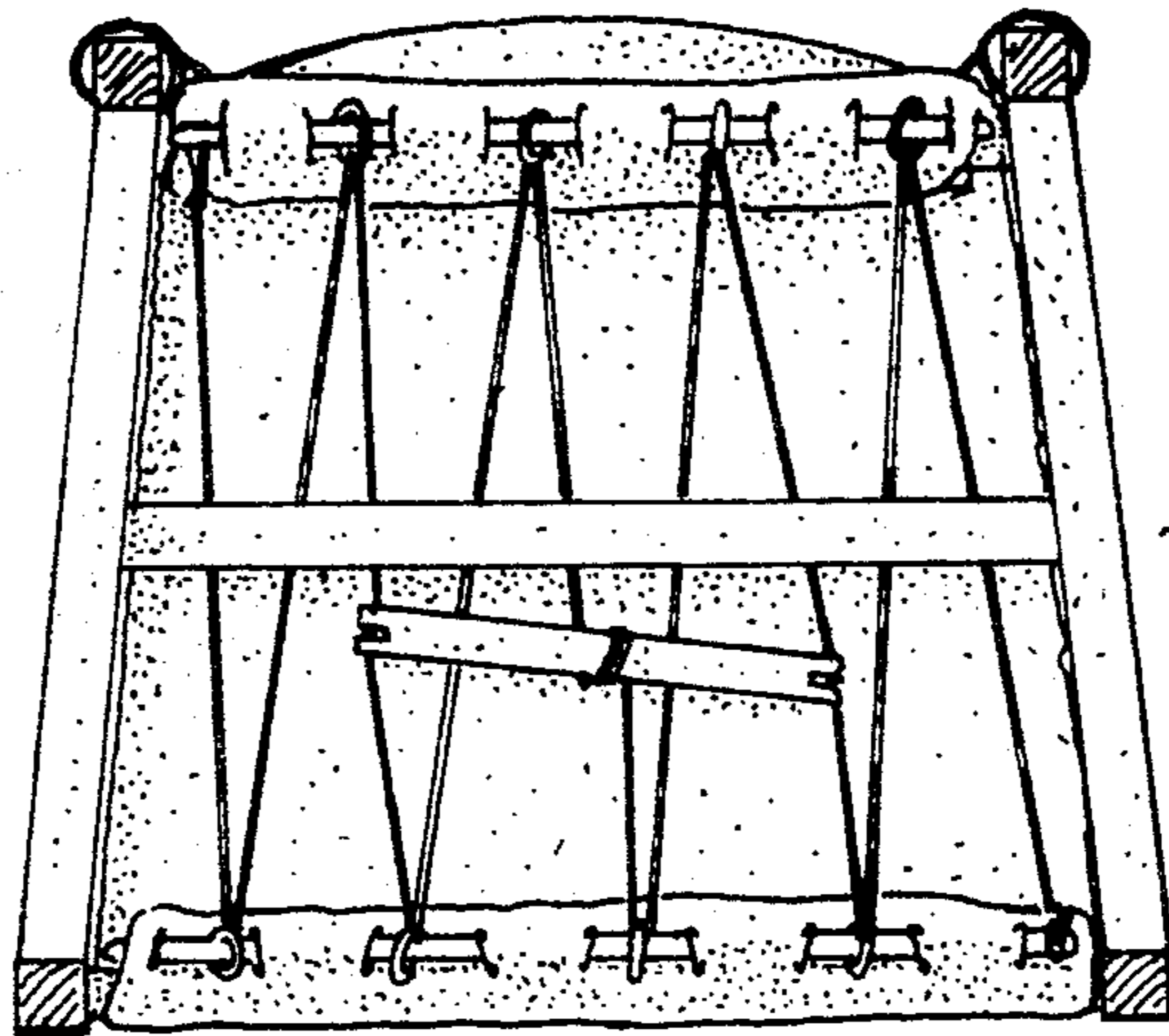
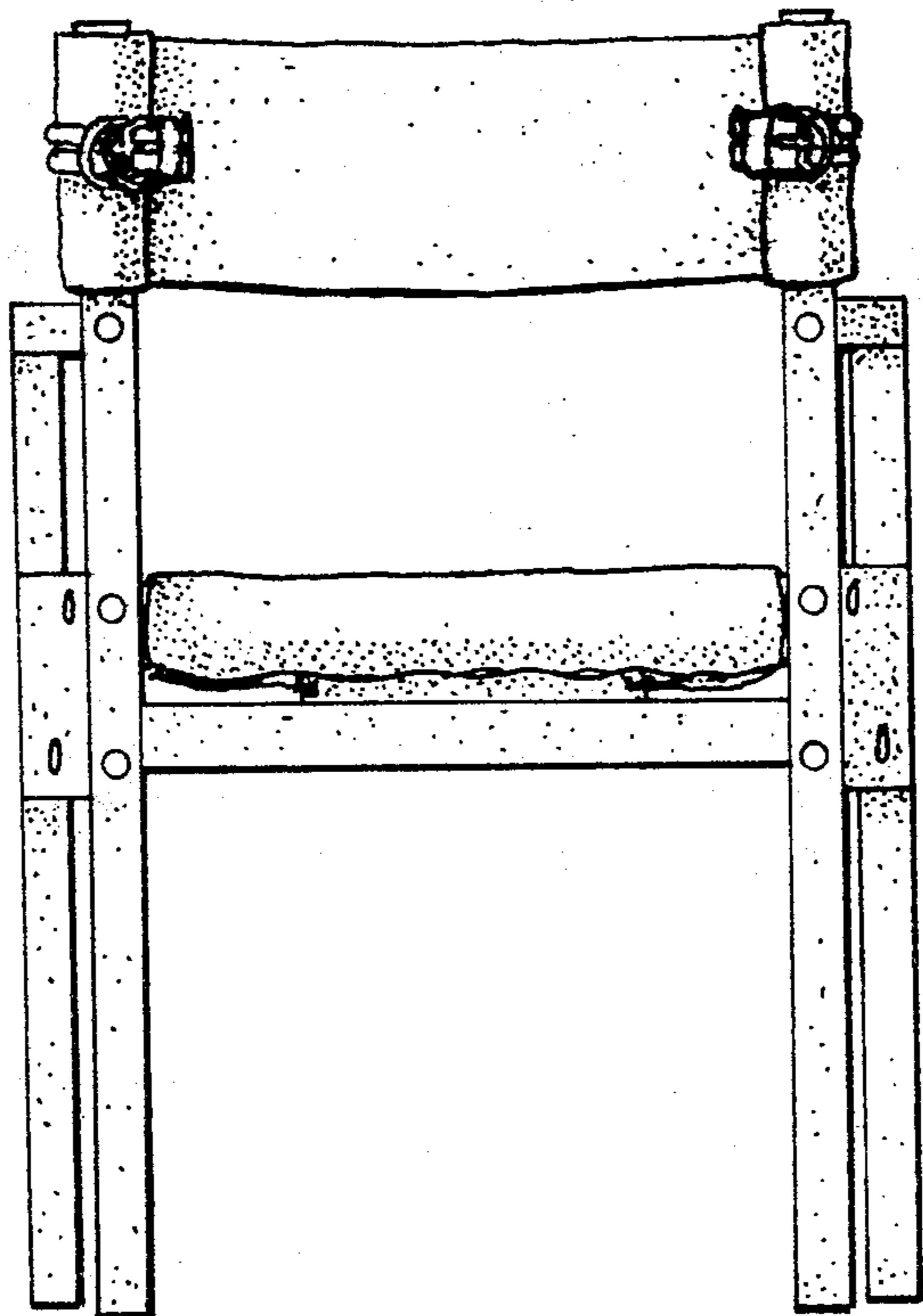

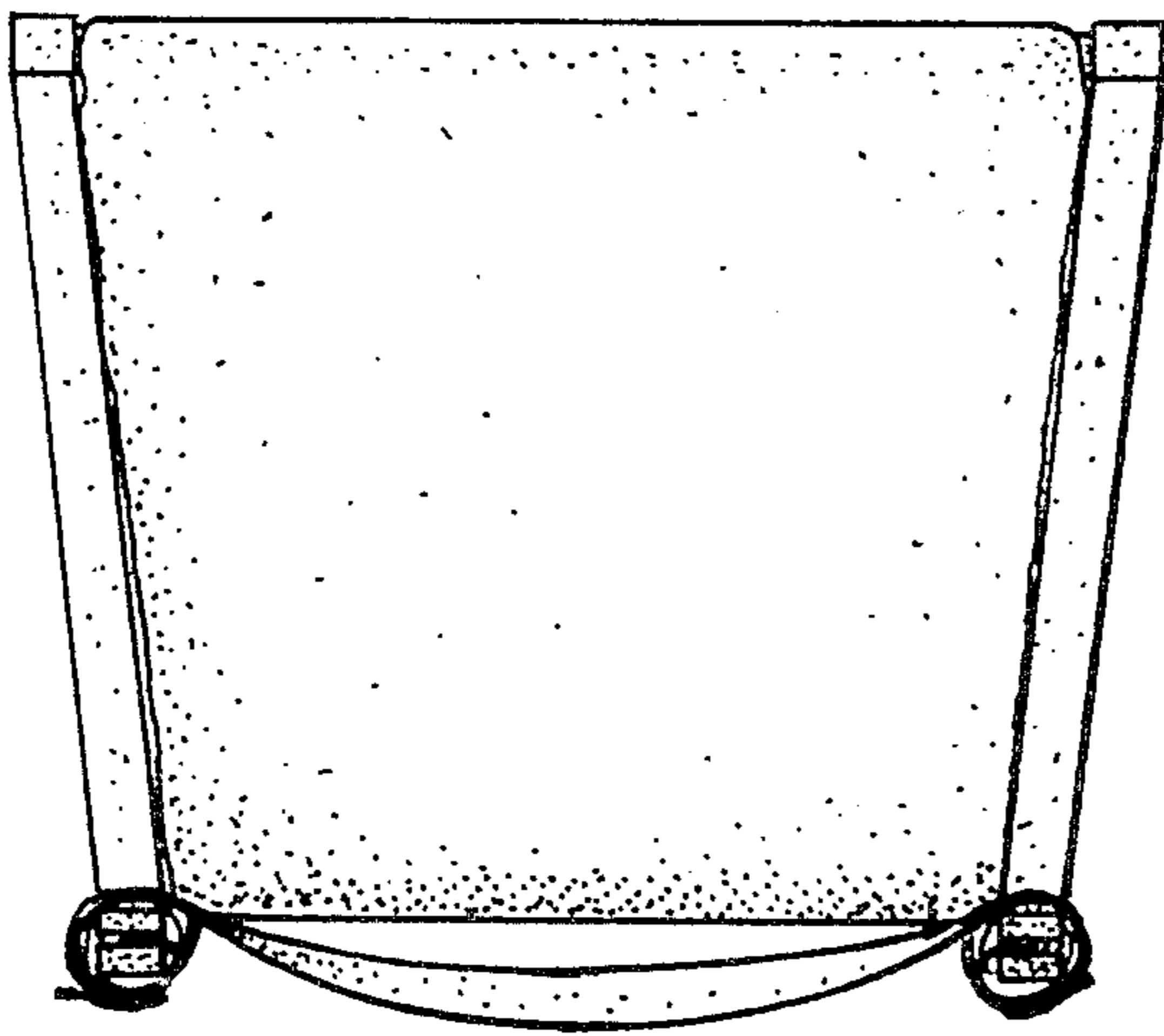

~ Fig. 5 ~

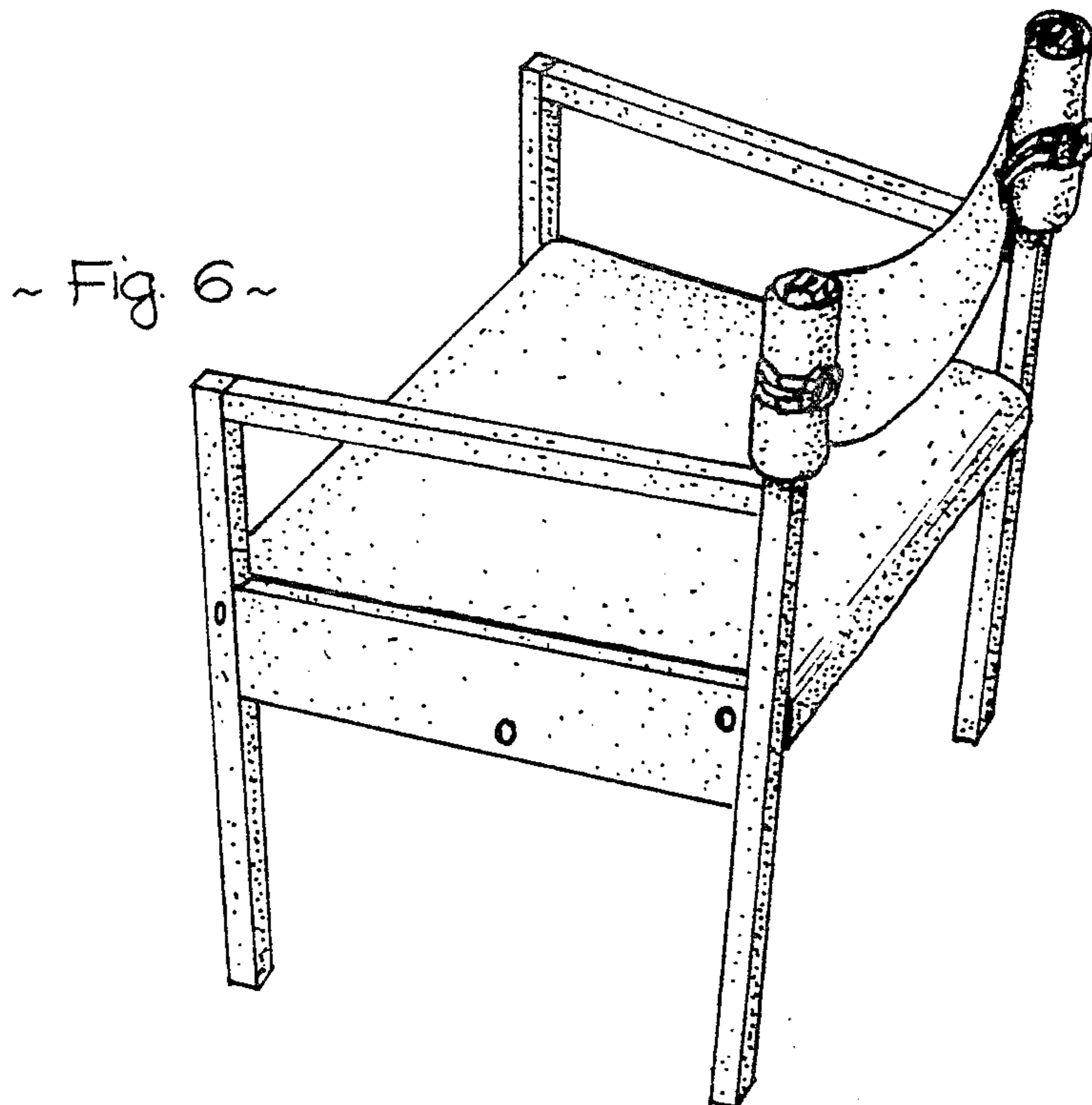

~ Fig. 6 ~