

- [54] COVERED FOOD STORAGE CONTAINER OR THE LIKE
- [75] Inventors: Robert H. C. M. Daenen, Hekelgem, Belgium; Rino Conti, Stoughton, Mass.
- [73] Assignee: Dart Industries Inc., Northbrook, Ill.
- [**] Term: 14 Years
- [21] Appl. No.: 406,796
- [22] Filed: Aug. 10, 1982
- [52] U.S. Cl. D7/79; D7/16; D7/81
- [58] Field of Search D9/418, 425, 431, 432; D7/76, 78, 79, 81, 16, 18, 19, 20

[56] References Cited

U.S. PATENT DOCUMENTS

D. 52,562	10/1918	Dickmeyer	D9/418
D. 92,697	7/1934	Bicks	D9/408
D. 112,656	12/1938	Hirschland	D7/79
D. 124,756	1/1941	Wright	D9/414
D. 207,175	3/1967	Brefka	D7/79
D. 211,682	7/1968	Elcholtz et al.	D9/425
D. 238,137	12/1975	Swett	D7/79
D. 250,870	1/1979	Stahel	D7/76
D. 257,107	9/1980	Daenen et al.	D7/1
2,575,770	11/1951	Roop	D7/79 X
2,606,586	8/1952	Hill	D7/76 X
4,293,079	10/1981	Lytle	220/306

OTHER PUBLICATIONS

Lustro Ware 65 Cat. #605, p. 10, top panel, 4 Food Containers Shown, Same Cover Fits All.
 Tupperware Catalog Dated Feb., 1982; p. 4-A35; p.

5-A65, A70, A75 & A85; p. 20-K57 & K60; p. 13-G35; p. 15-H55 & H60; p. 26-P70 & P75.
 Buchsteiner Brochure Dated Jul., 1979; Products Art. Nr. 3320 and 3322.
 Sarvis Brochure (Date Unknown).
 Copco Catalog (1982) pp. 6 and 7-Food Savers.

Primary Examiner—Winifred E. Herrmann
Attorney, Agent, or Firm—John A. Doninger

[57] CLAIM

The ornamental design for a covered food storage container or the like, substantially as shown and described.

DESCRIPTION

FIG. 1 is a top perspective view of a covered food storage container or the like showing our new design; FIGS. 2-4 are top perspective views of modifications of the covered food storage container of FIG. 1; FIG. 5 is an end elevational view of FIG. 1; the end opposite being identical thereto; FIGS. 6-8 are end elevational views of FIGS. 2-4 respectively, the opposite ends being identical thereto; FIG. 9 is a side elevational view of FIG. 1; the side opposite being identical thereto; FIGS. 10-12 are side elevational views of FIGS. 2-4 respectively, the sides opposite being identical thereto; FIG. 13 is a top plan view of FIG. 1, it being understood that the size and proportions of the top plan of FIGS. 2-4 are identical hereto; and FIG. 14 is a bottom plan view of FIG. 1, it being understood that the size and proportions of the bottom plan of FIGS. 2-4 are identical hereto.
 The stippled shading on the design represents a frosted (opaque or translucent) material and the end walls thereof are shaded to represent a semi-transparent material.

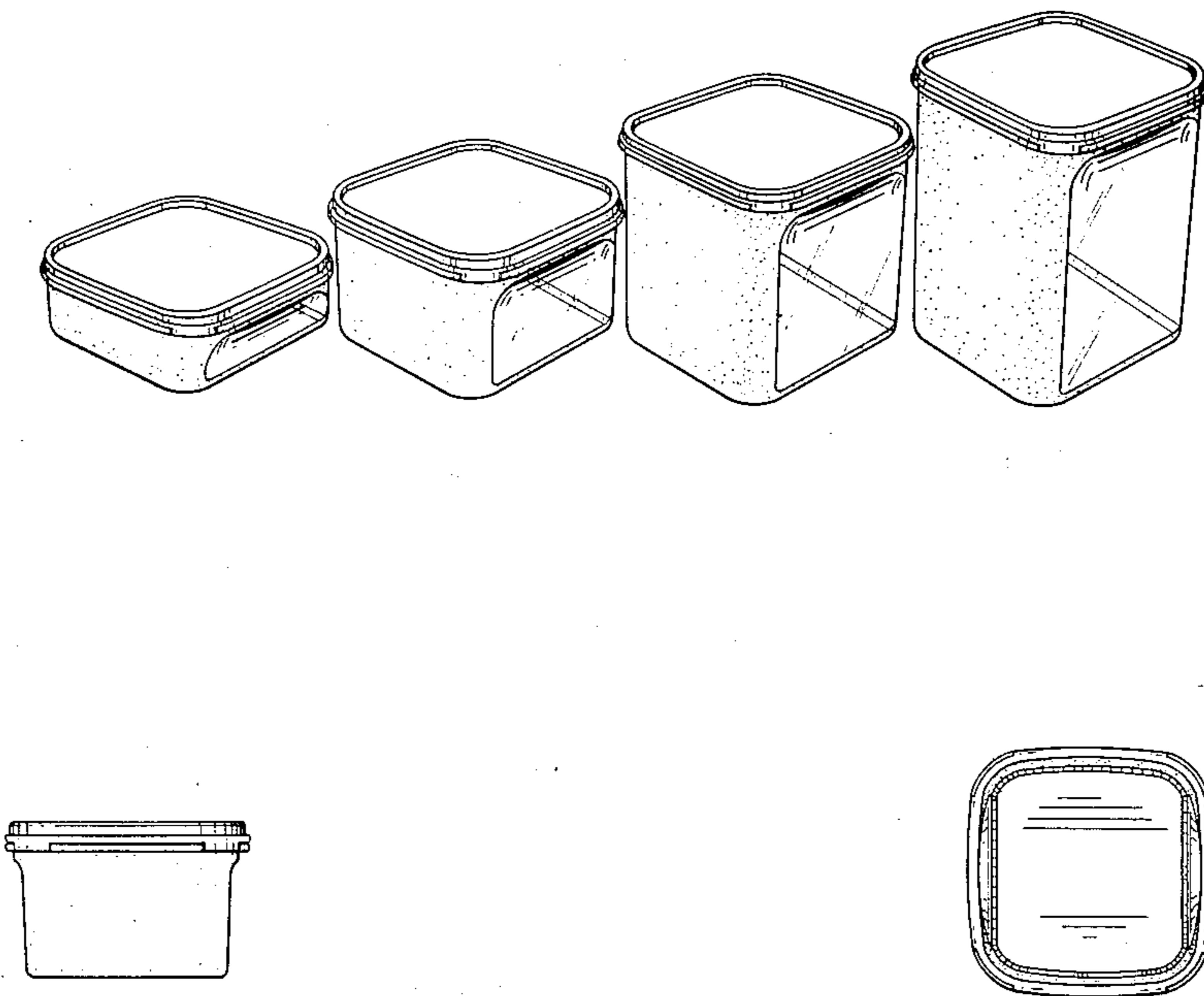

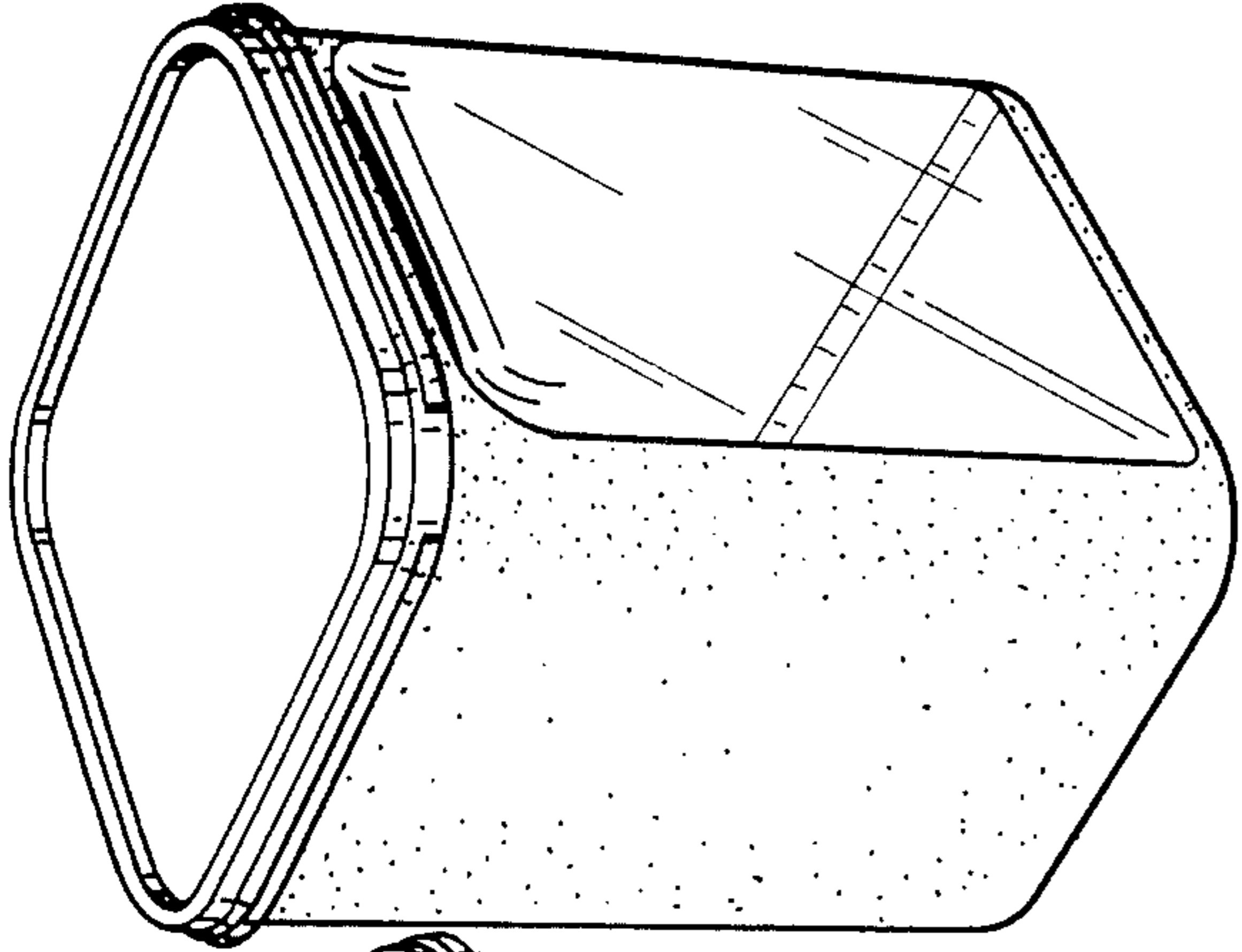

FIG. 1

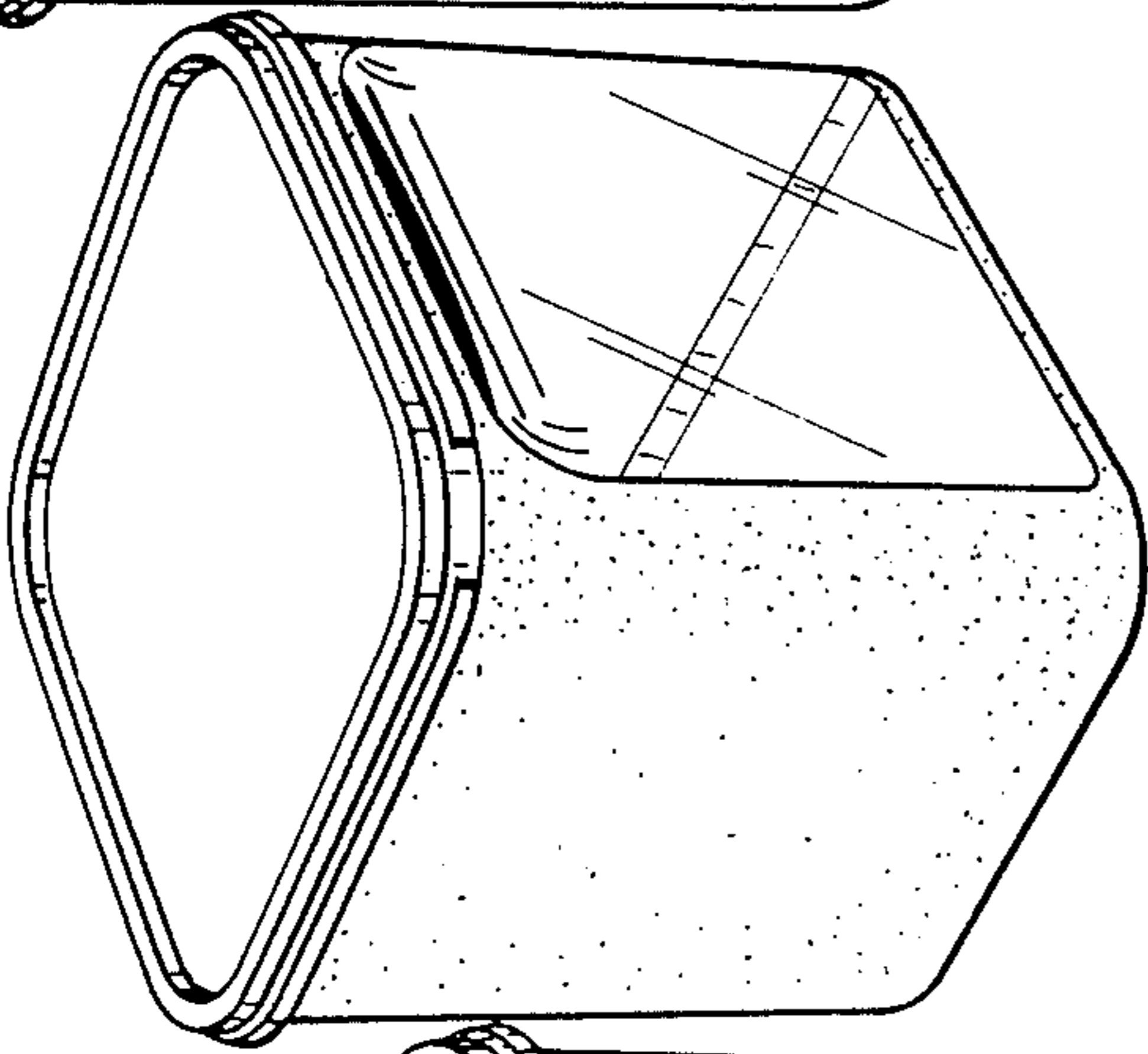

FIG. 2

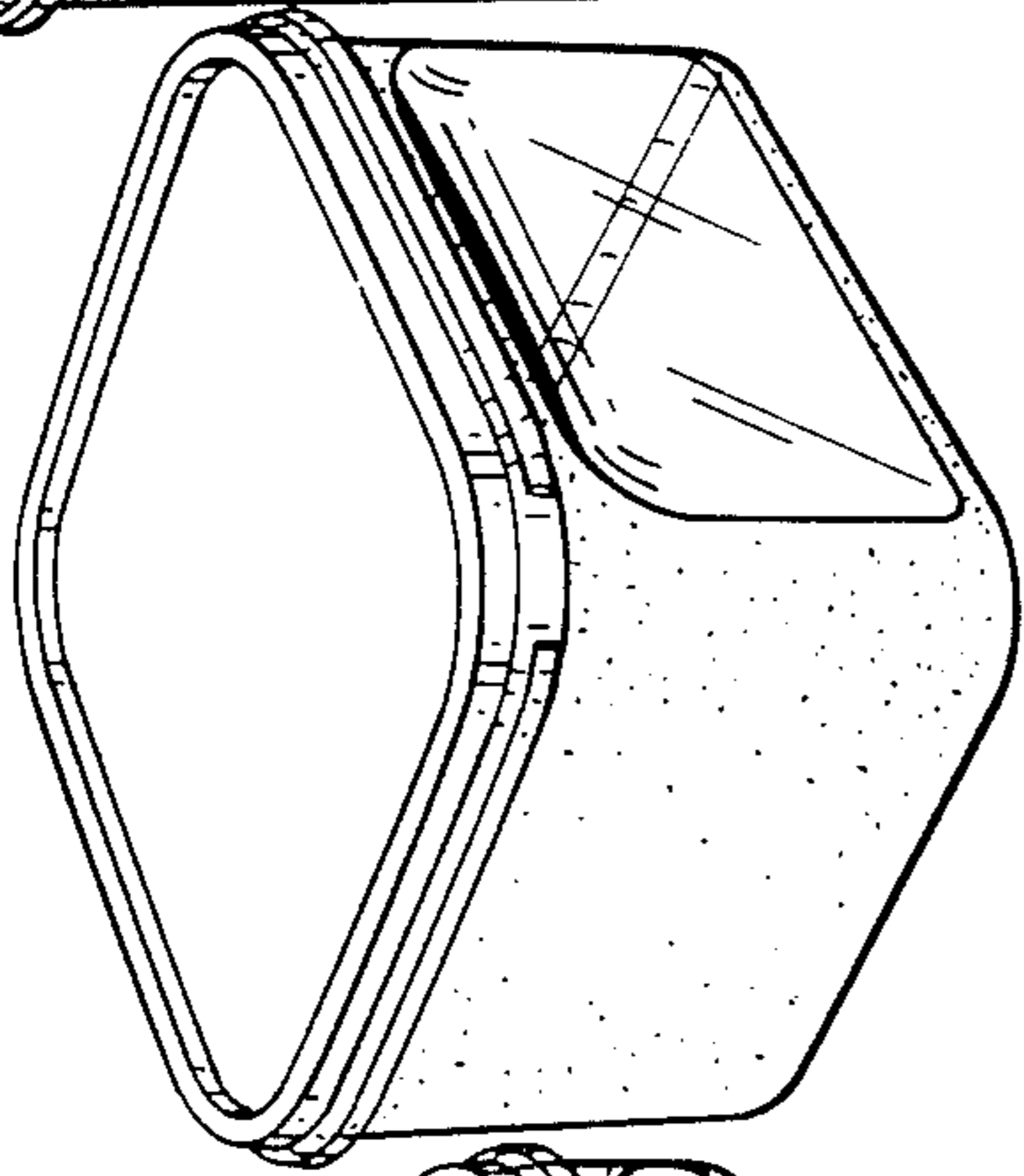

FIG. 3

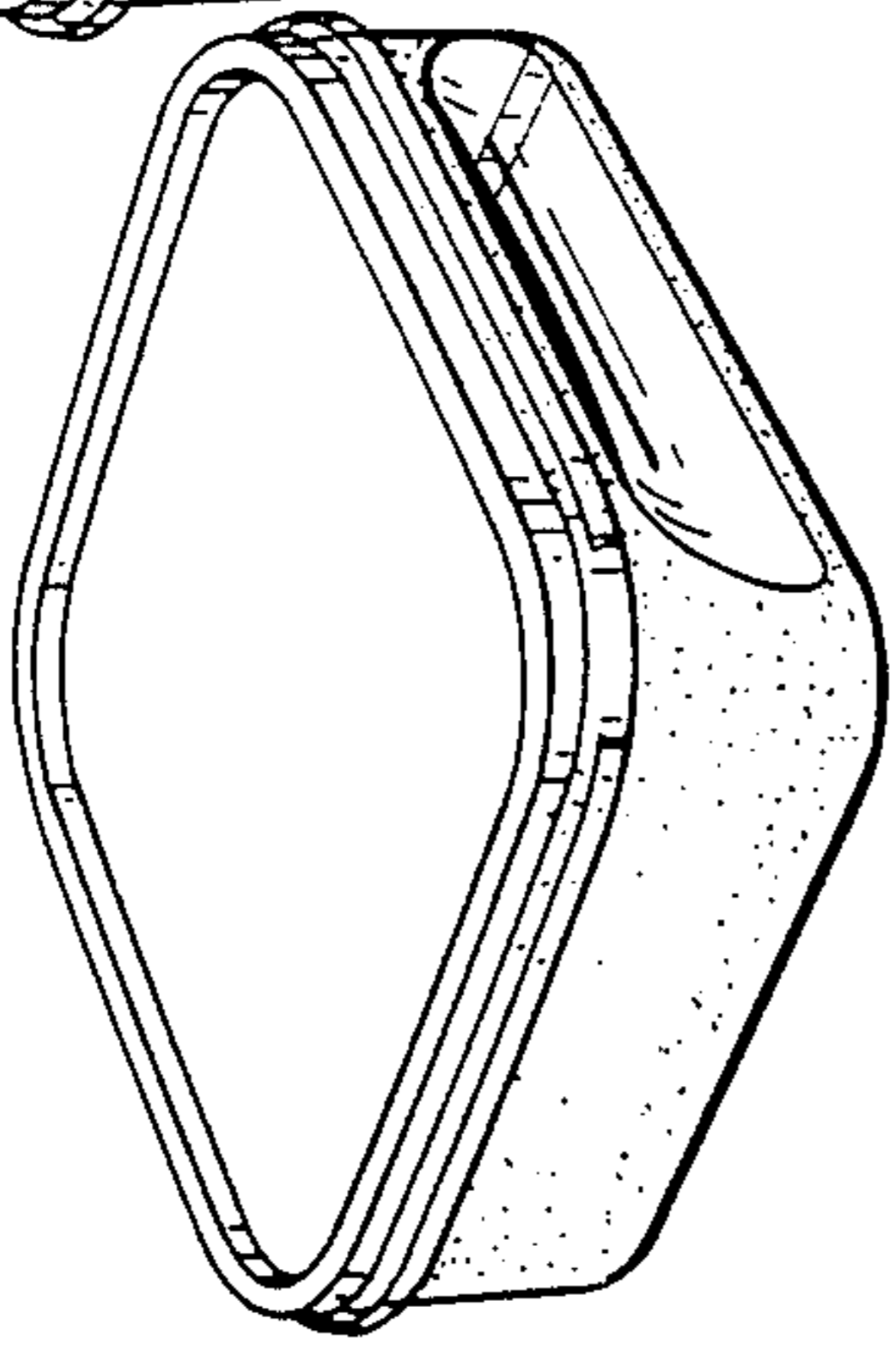

FIG. 4

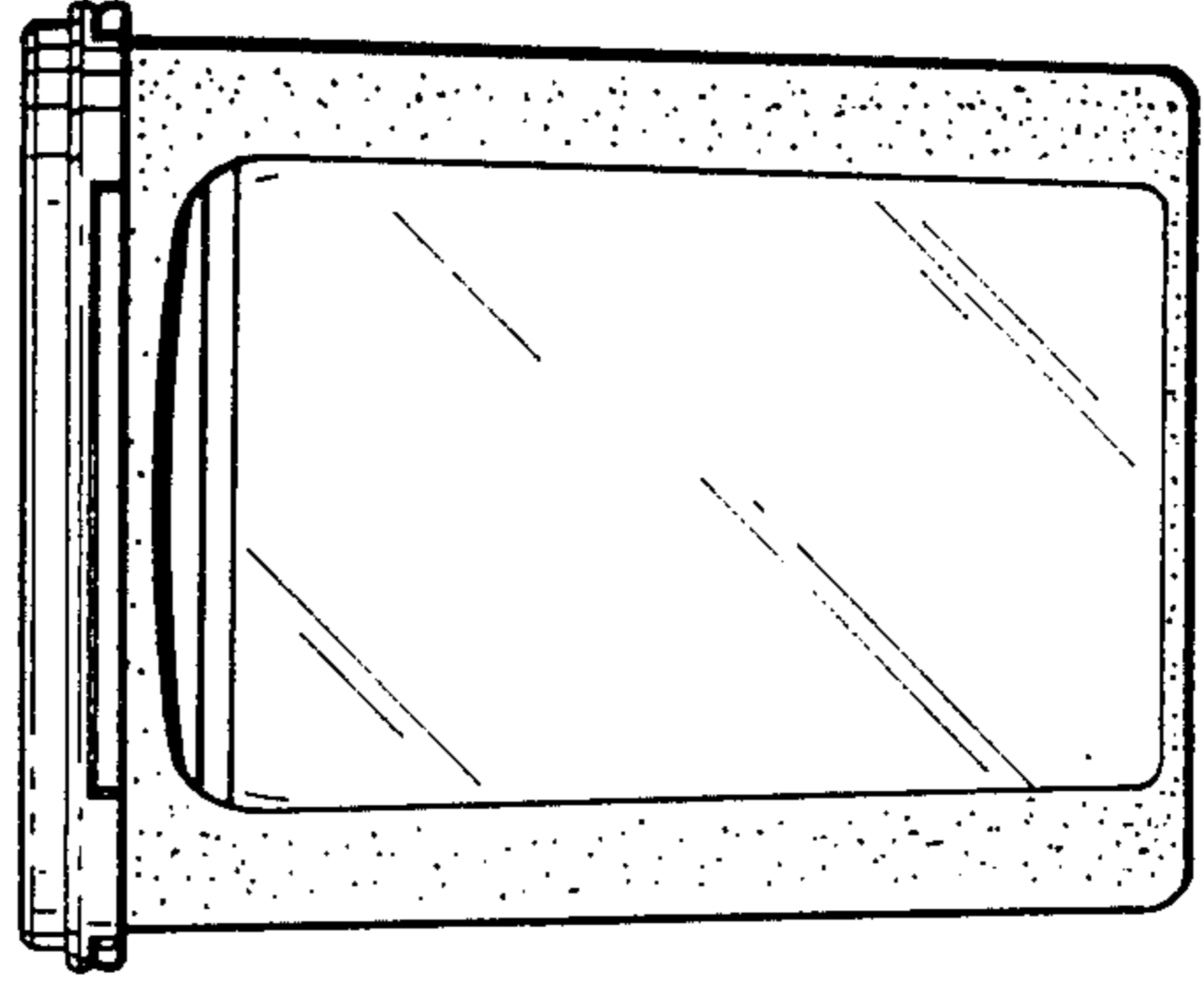

FIG. 5

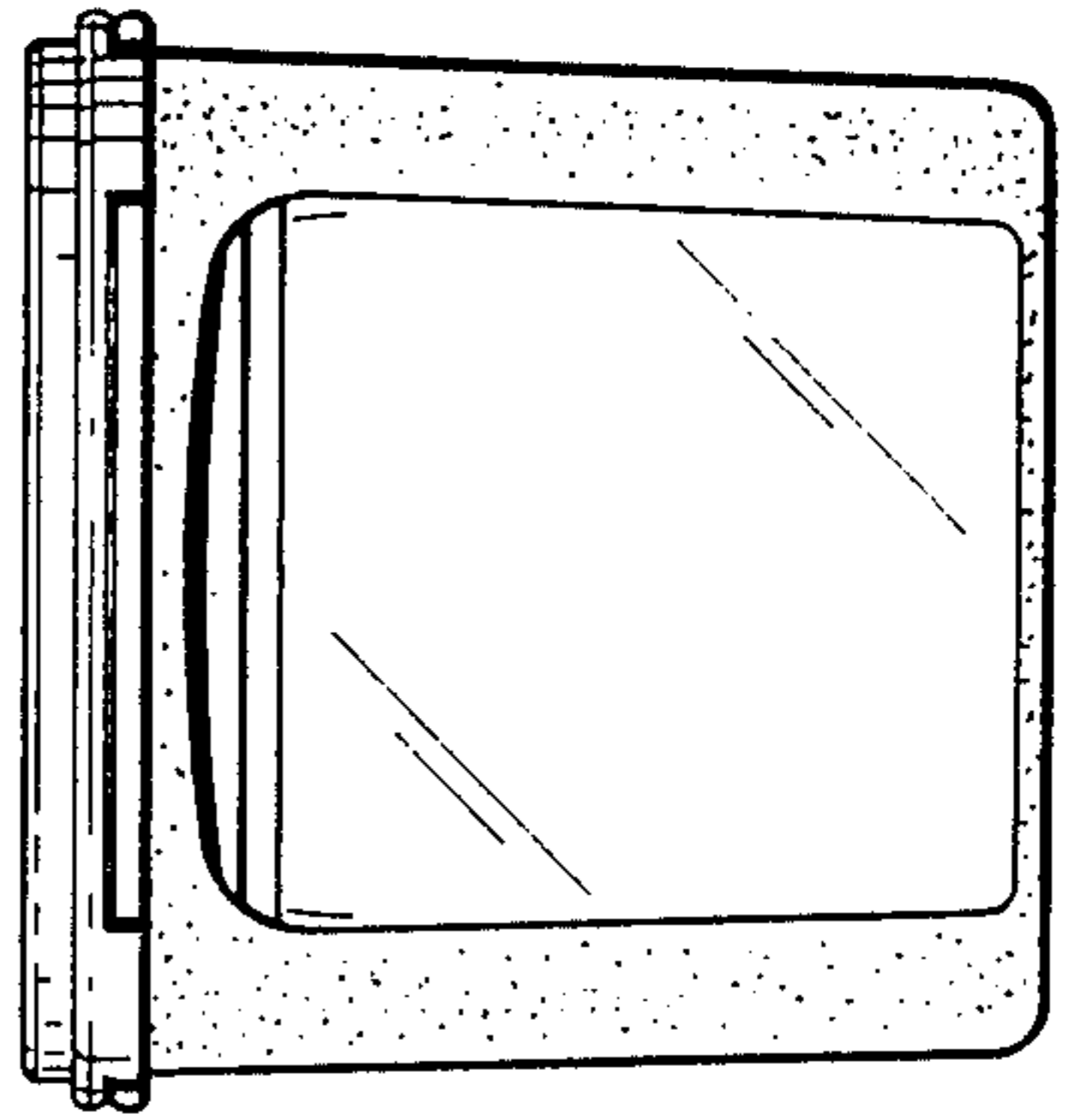

FIG. 6

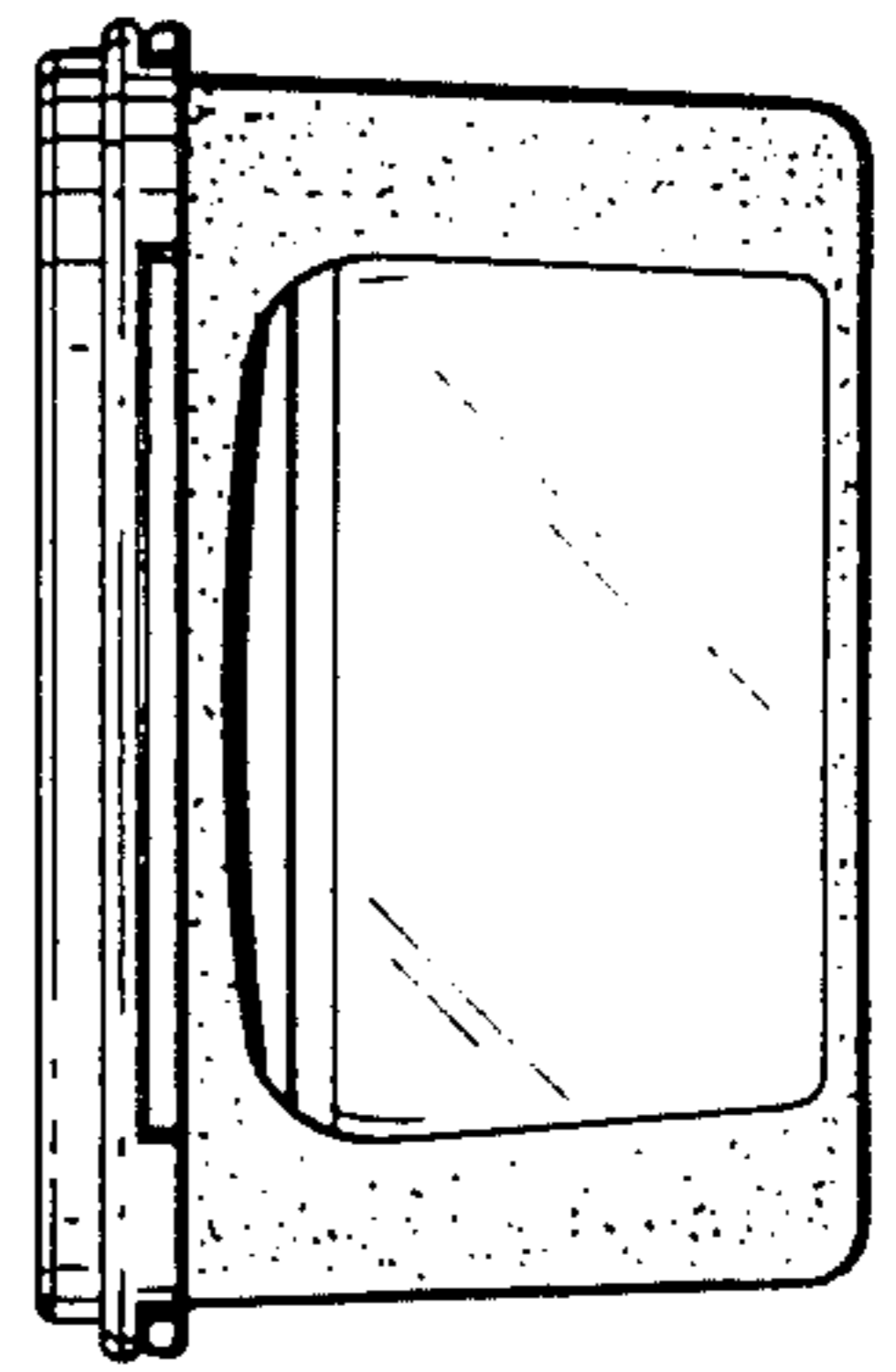

FIG. 7

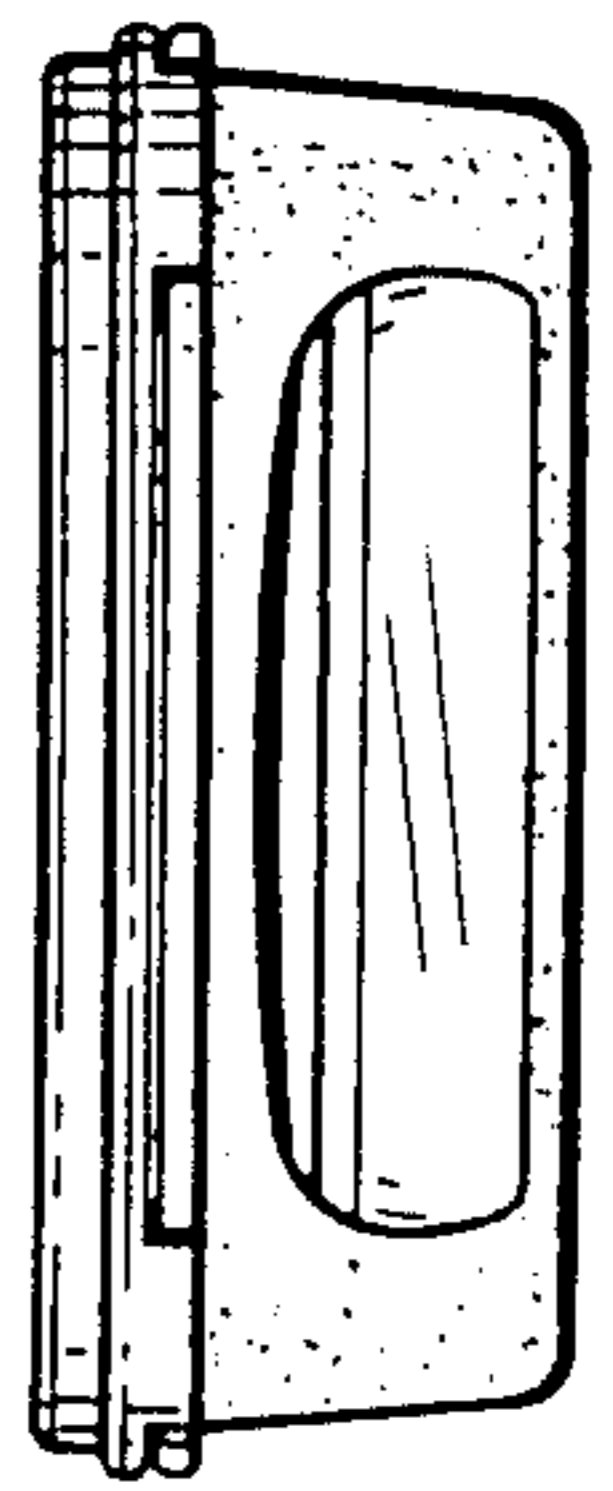

FIG. 8

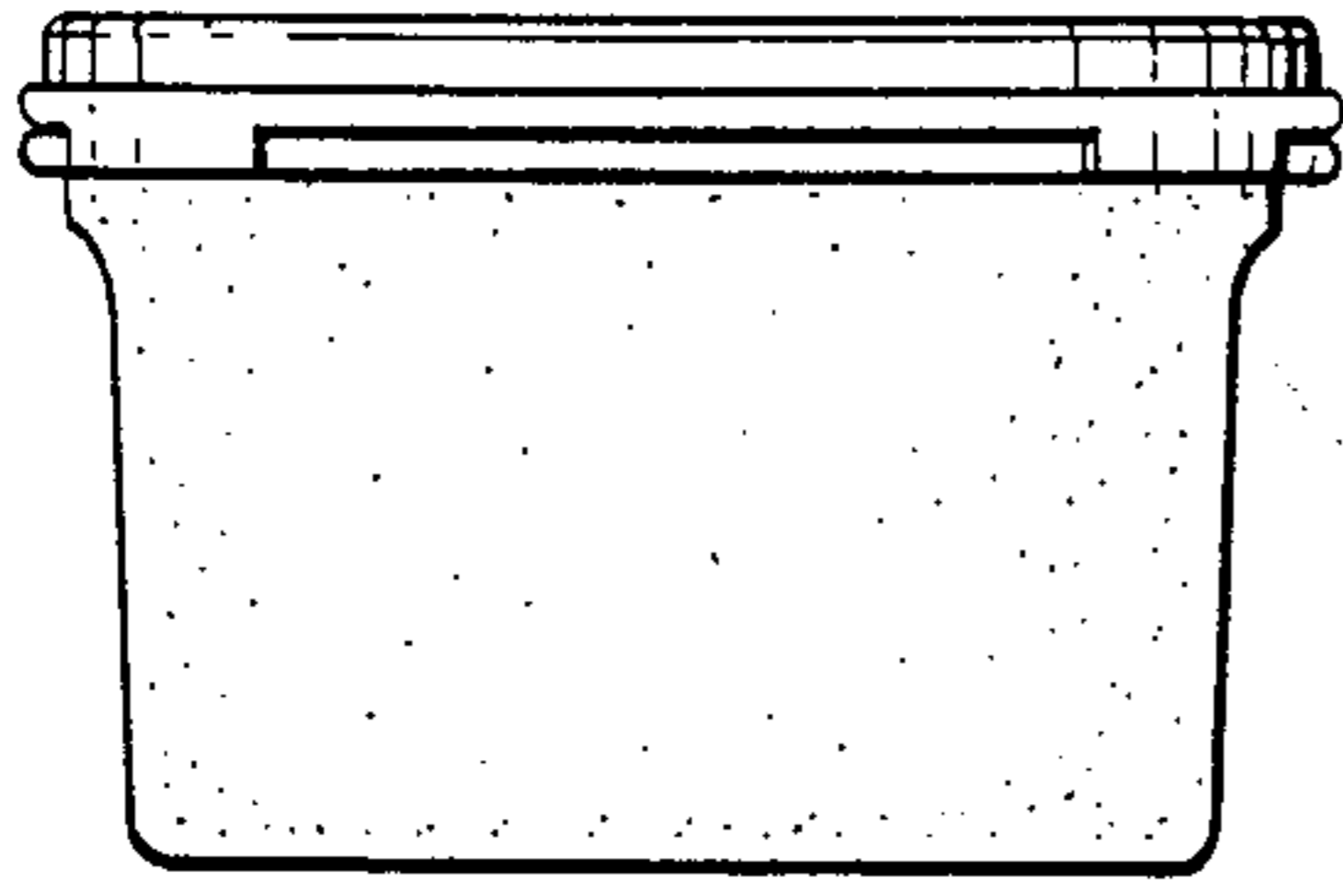

FIG. 9

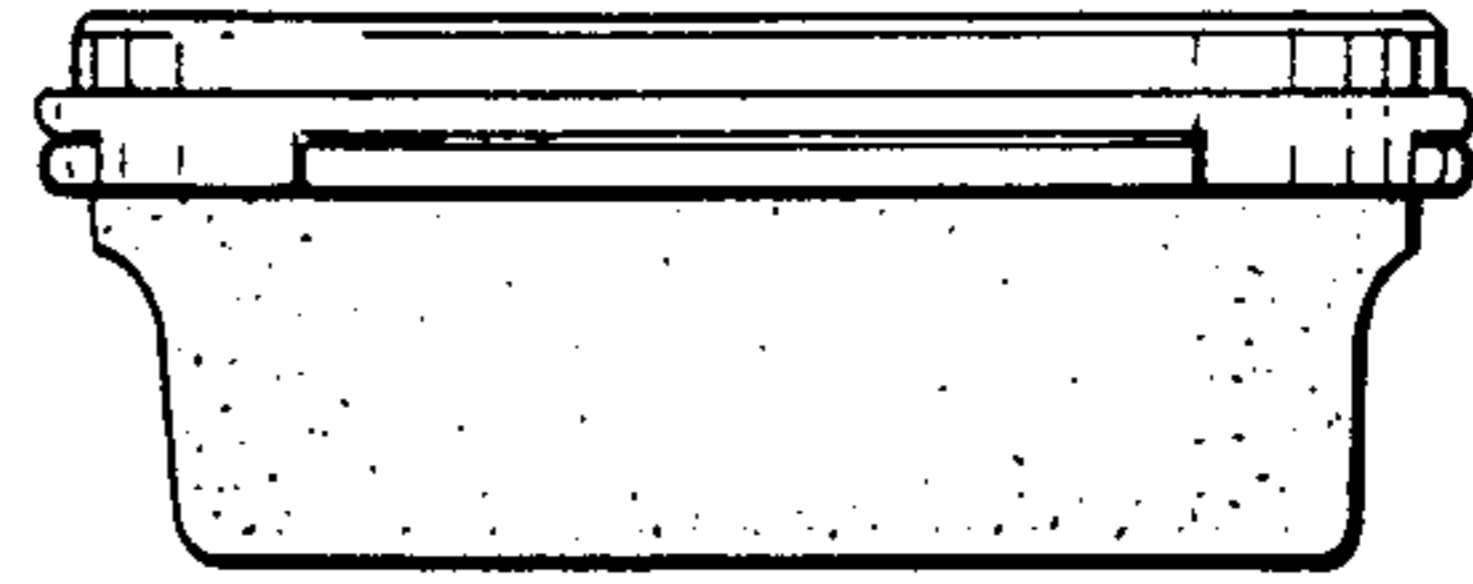

FIG. 10

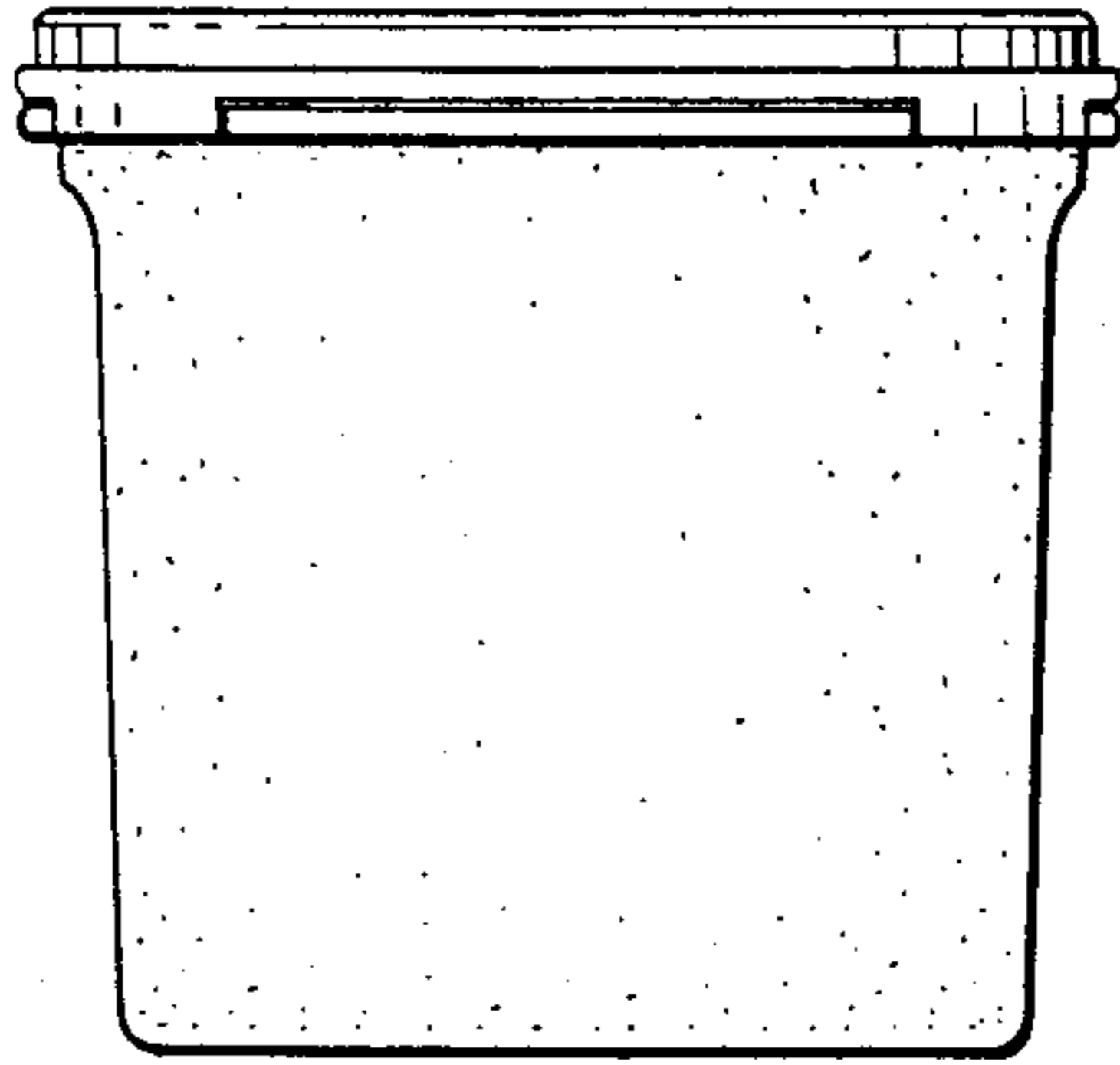

FIG. 11

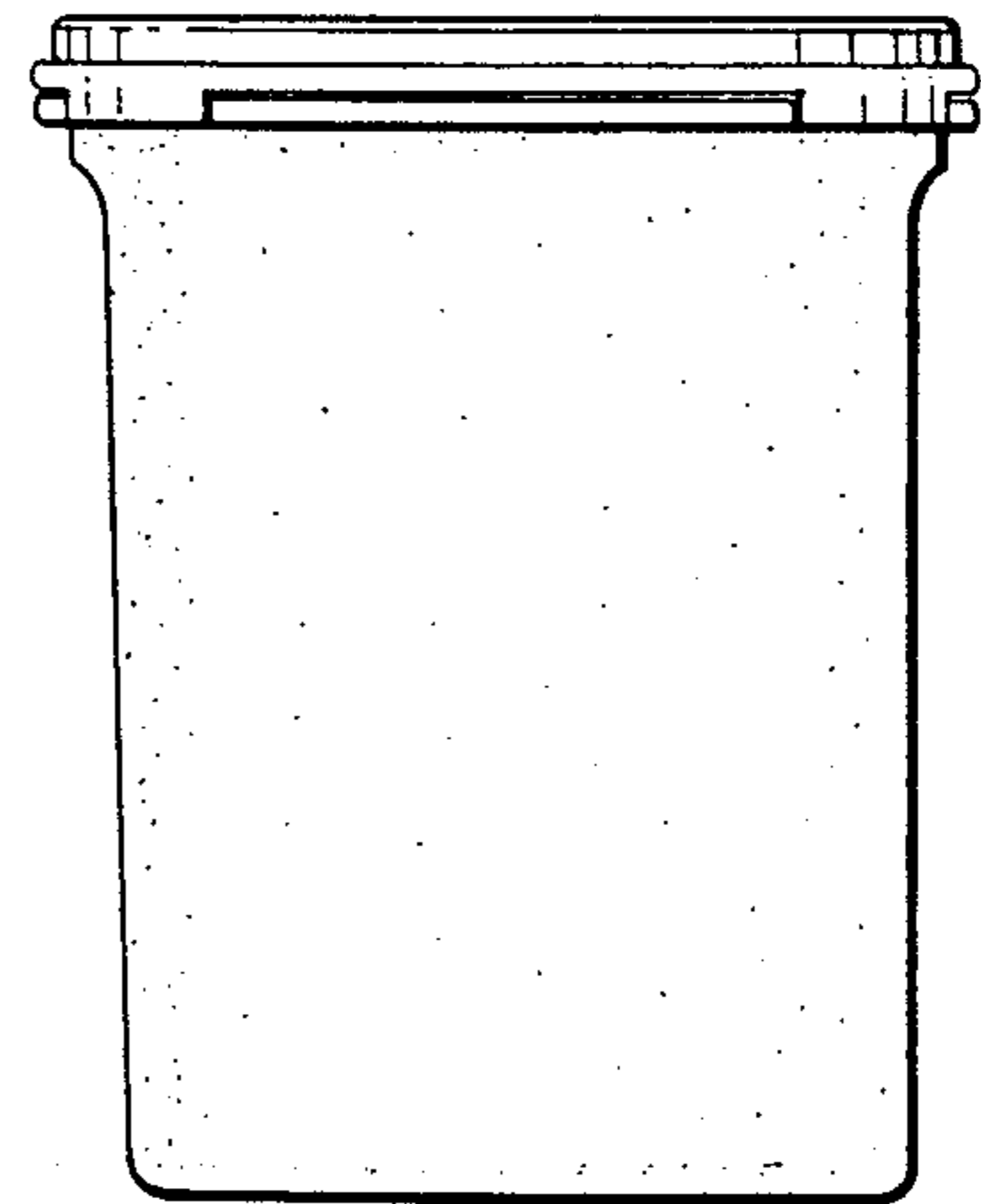

FIG. 12

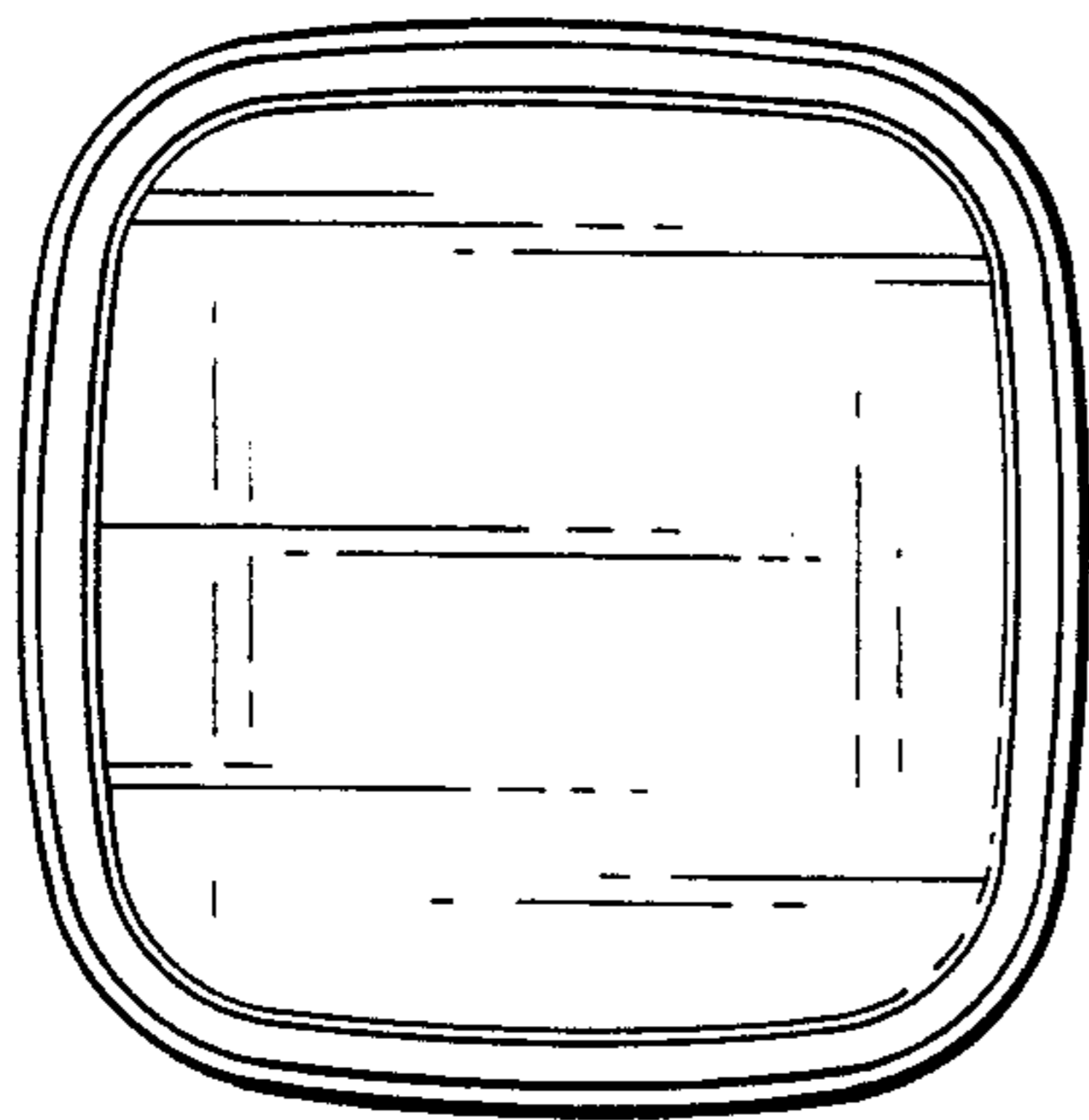

FIG. 13

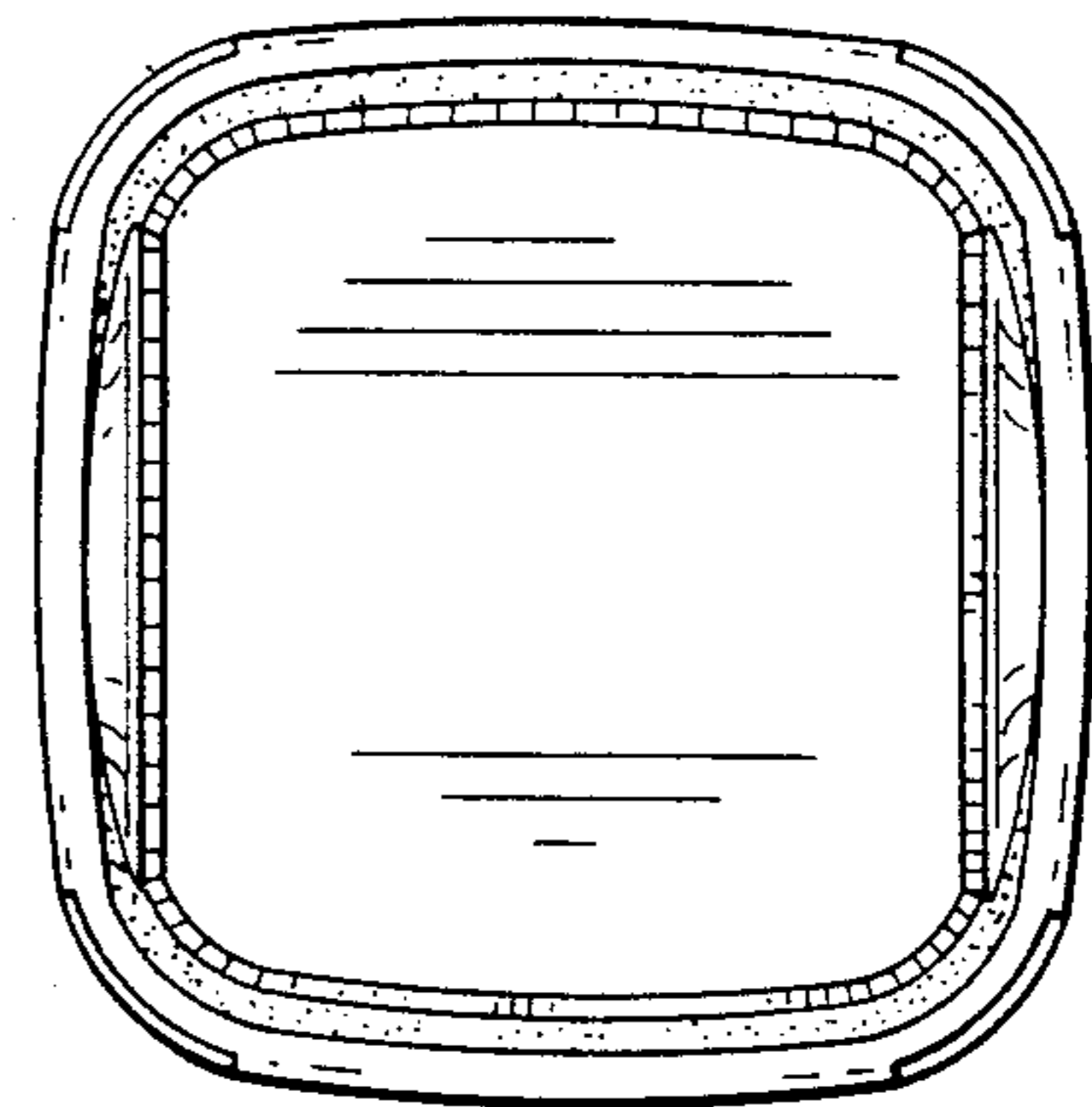

FIG. 14