

# United States Patent [19]

Bounds

[11] Patent Number: **Des. 279,158**

[45] Date of Patent: **\*\* Jun. 11, 1985**

[54] **CONDIMENT DISPENSER**

[76] Inventor: **William E. Bounds**, 3737 W. 240th St., Torrance, Calif. 90505

[\*\*] Term: **14 Years**

[21] Appl. No.: **445,249**

[22] Filed: **Nov. 29, 1982**

[52] U.S. Cl. .... **D7/54; D7/57**

[58] Field of Search ..... **D7/52-58**

[56] **References Cited**

### U.S. PATENT DOCUMENTS

D. 160,876	11/1950	Mesi	.....	D7/57
D. 254,238	2/1980	Morin	.....	D7/52 X
D. 257,204	10/1980	Bounds	.....	D7/57
D. 258,257	2/1981	Bounds	.....	D7/53
2,469,034	5/1949	Garris	.....	D7/57 X
3,096,910	7/1963	Pehr	.....	D7/54 X

3,323,683	6/1967	Cianciolo	.....	D7/54 X
4,193,521	3/1980	Bounds	.....	D7/57 X

*Primary Examiner*—Winifred E. Herrmann  
*Attorney, Agent, or Firm*—Edward A. Sokolski

### [57] CLAIM

The ornamental design for a condiment dispenser, as shown and described.

### DESCRIPTION

FIG. 1 is a top plan view of a condiment dispenser showing my new design;  
FIG. 2 is a front elevational view;  
FIG. 3 is a bottom plan view;  
FIG. 4 is a rear elevational view;  
FIG. 5 is a side elevational view;  
FIG. 6 is a side elevational view from the side opposite to that shown in FIG. 5; and  
FIG. 7 is a top front perspective view.

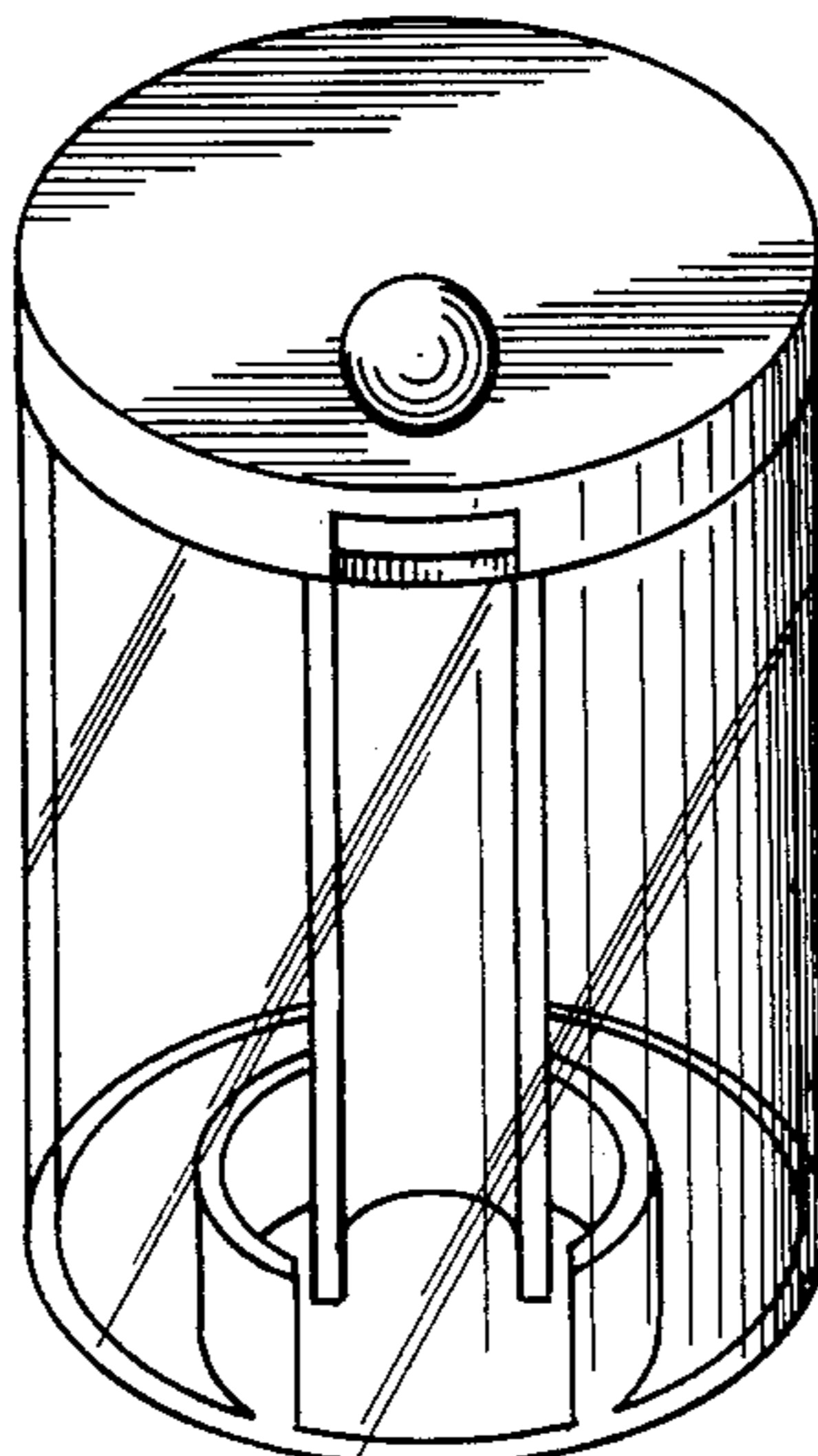
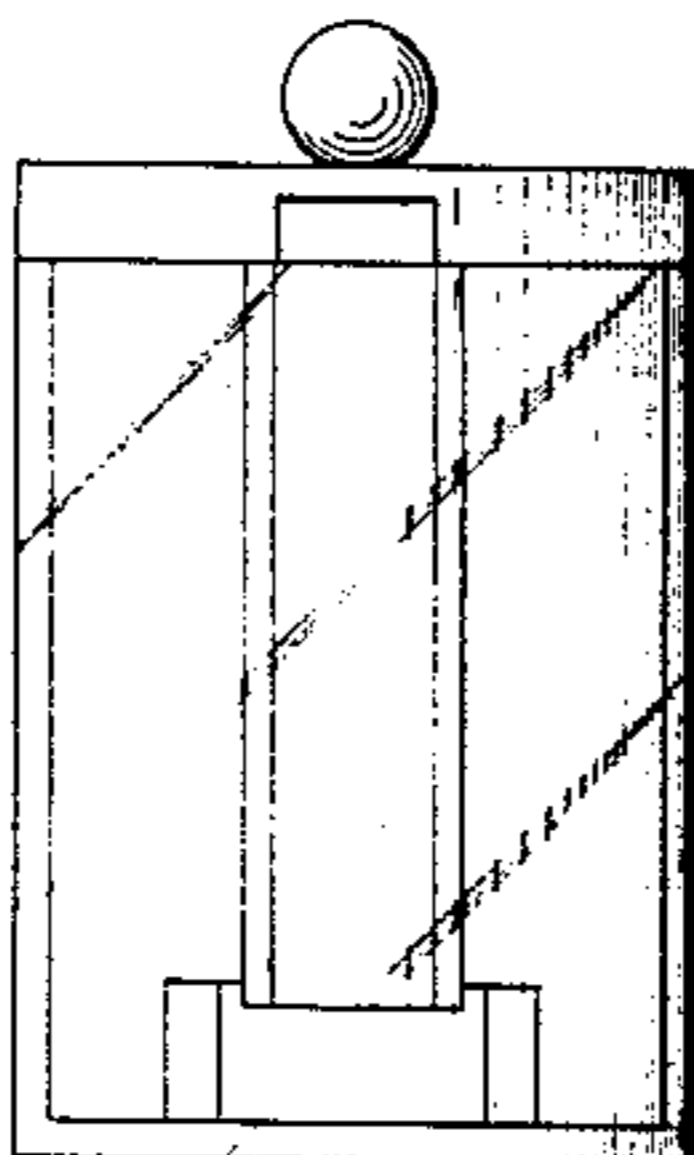
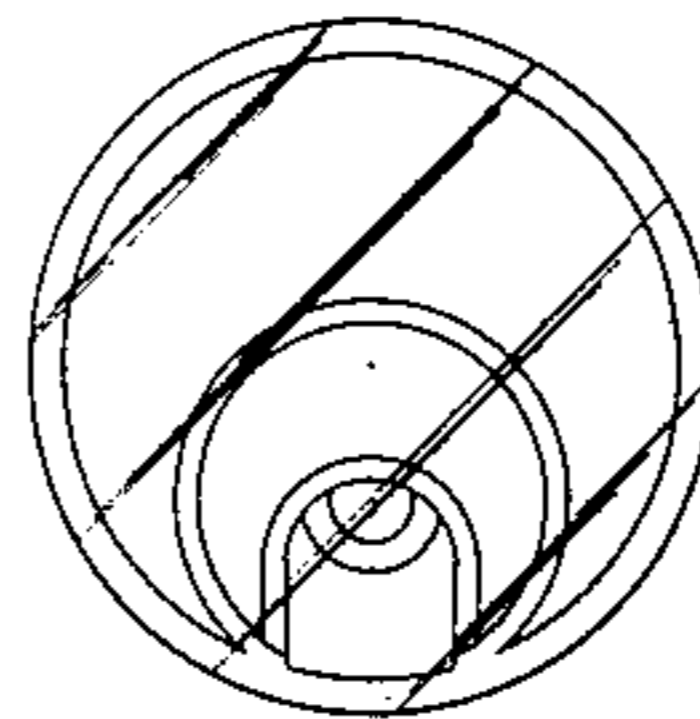

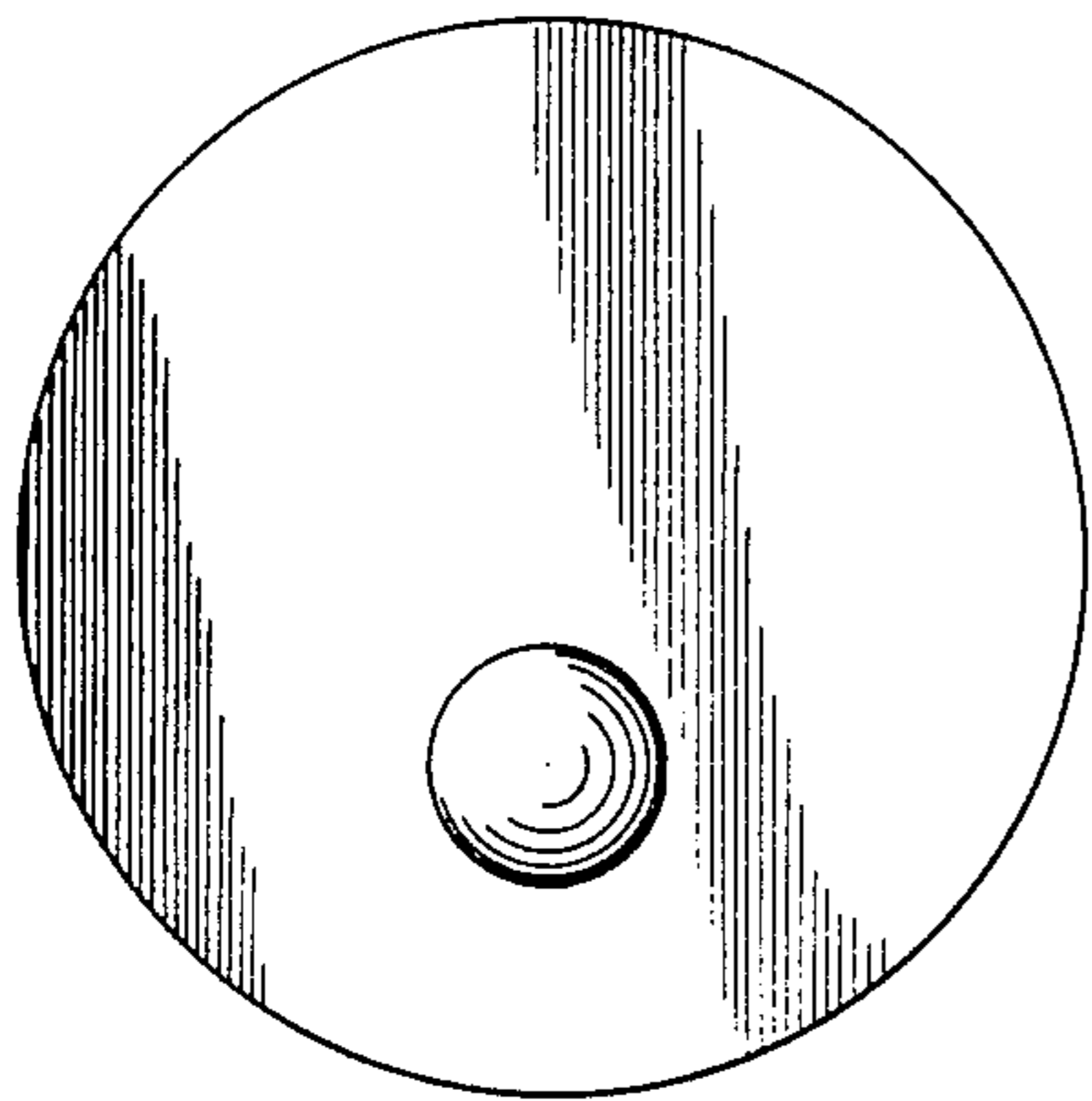

FIG. 1

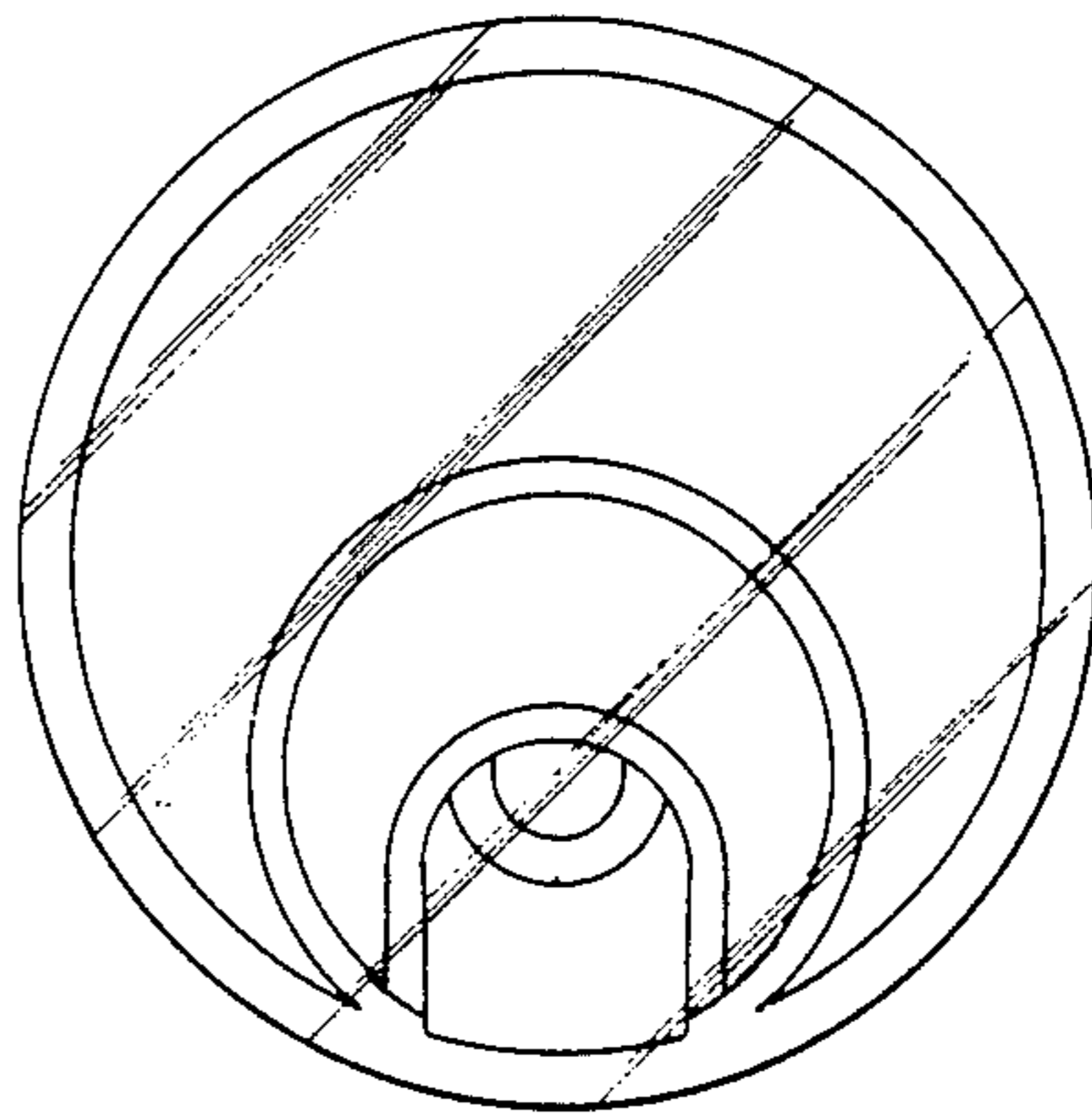

FIG. 3

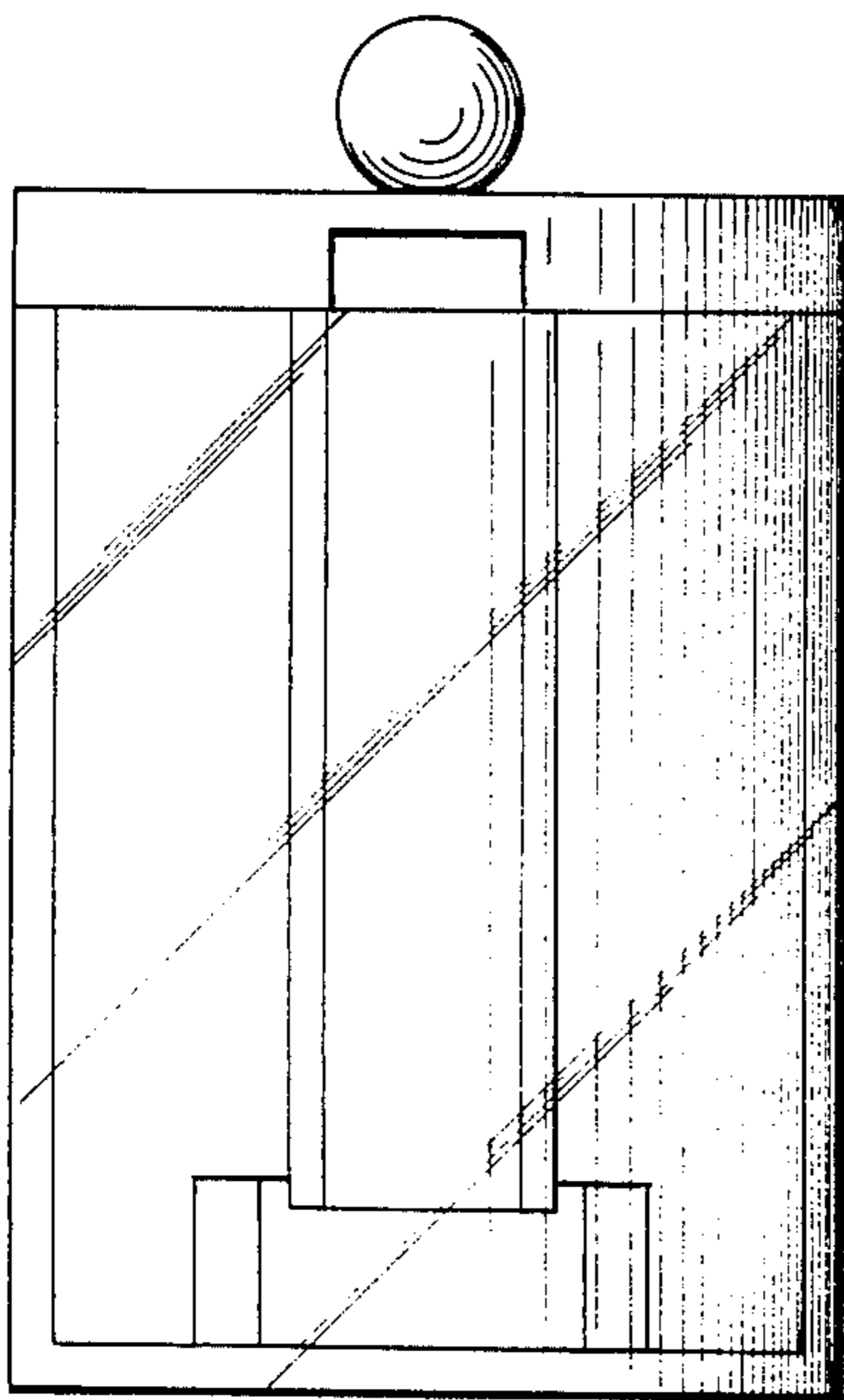

FIG. 2

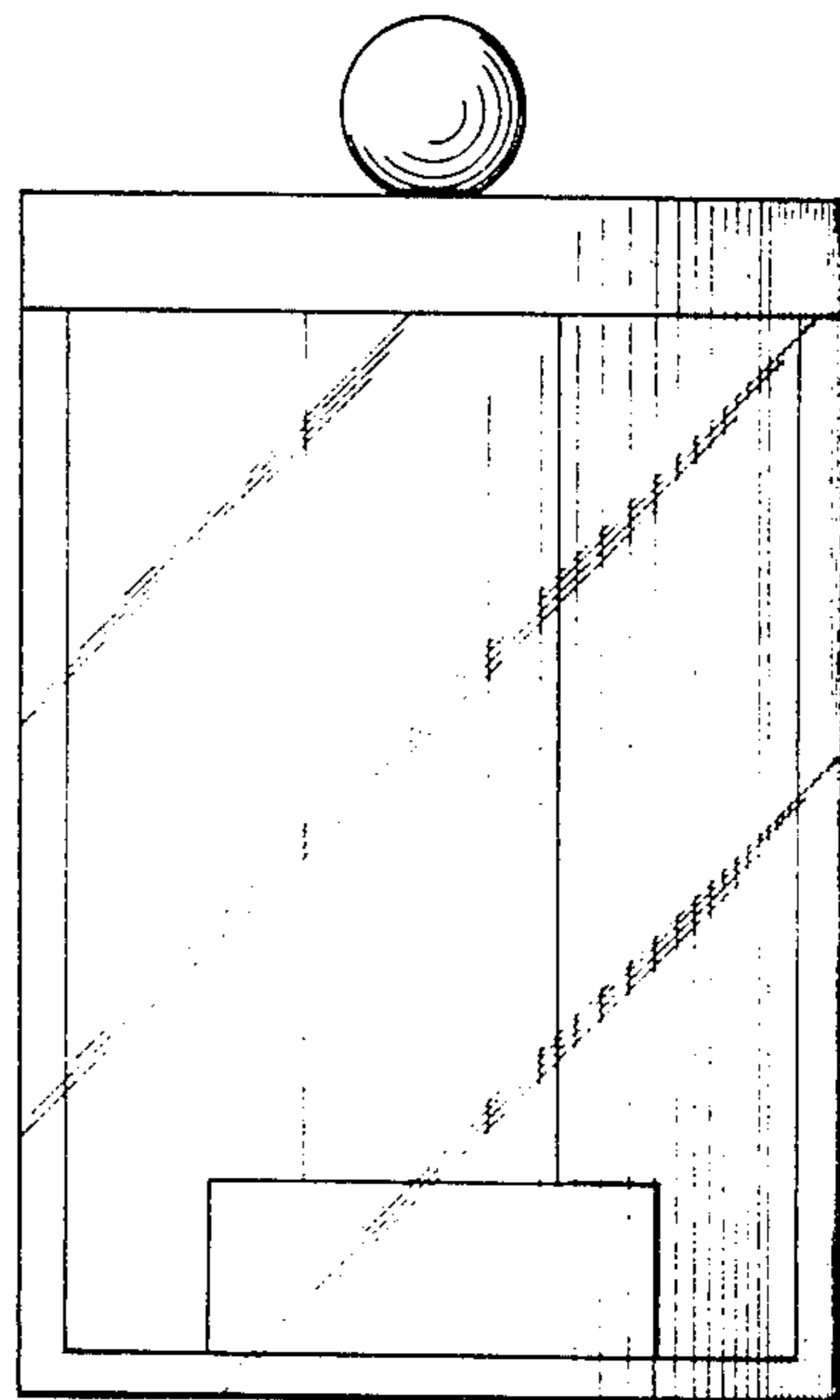

FIG. 4

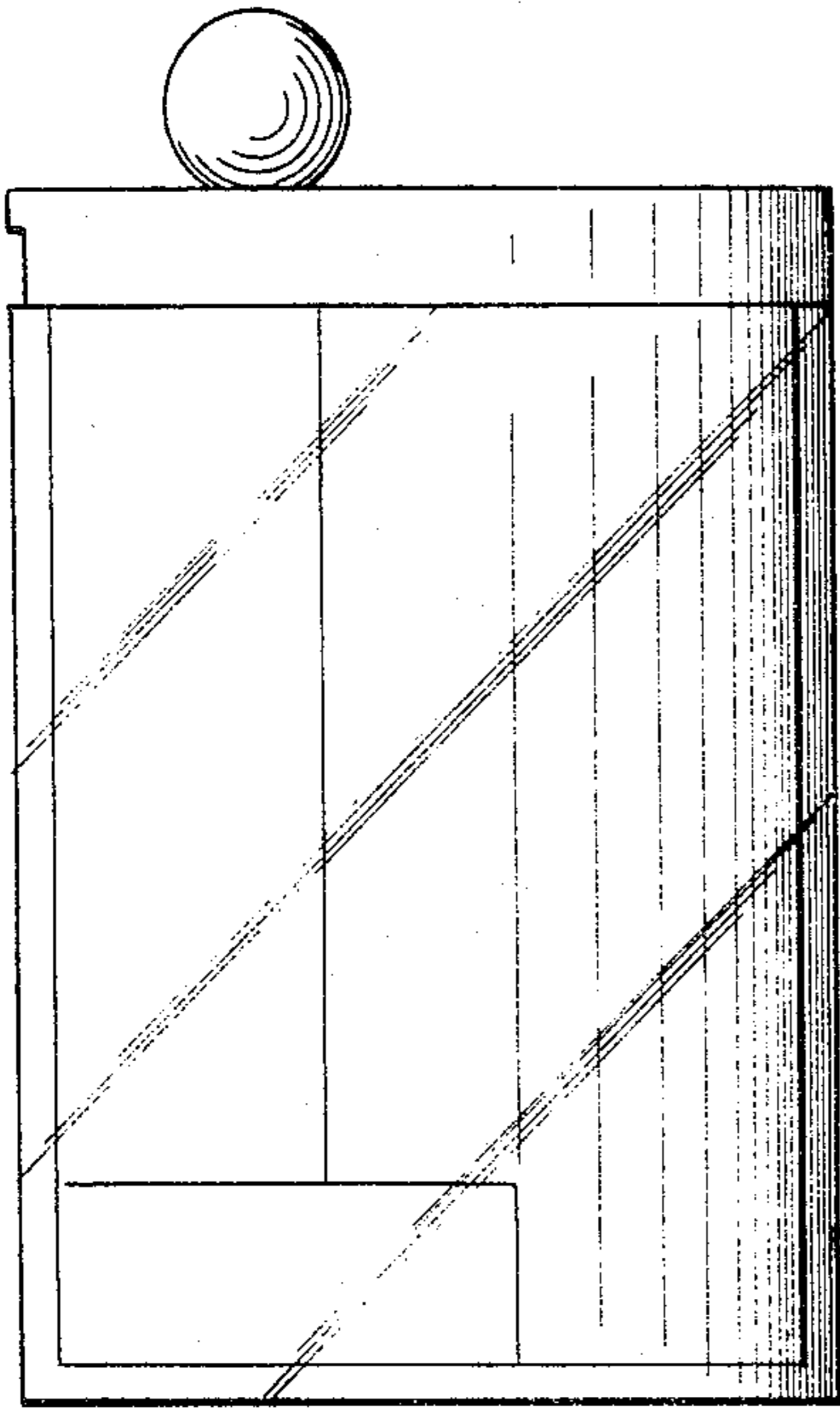

FIG. 5

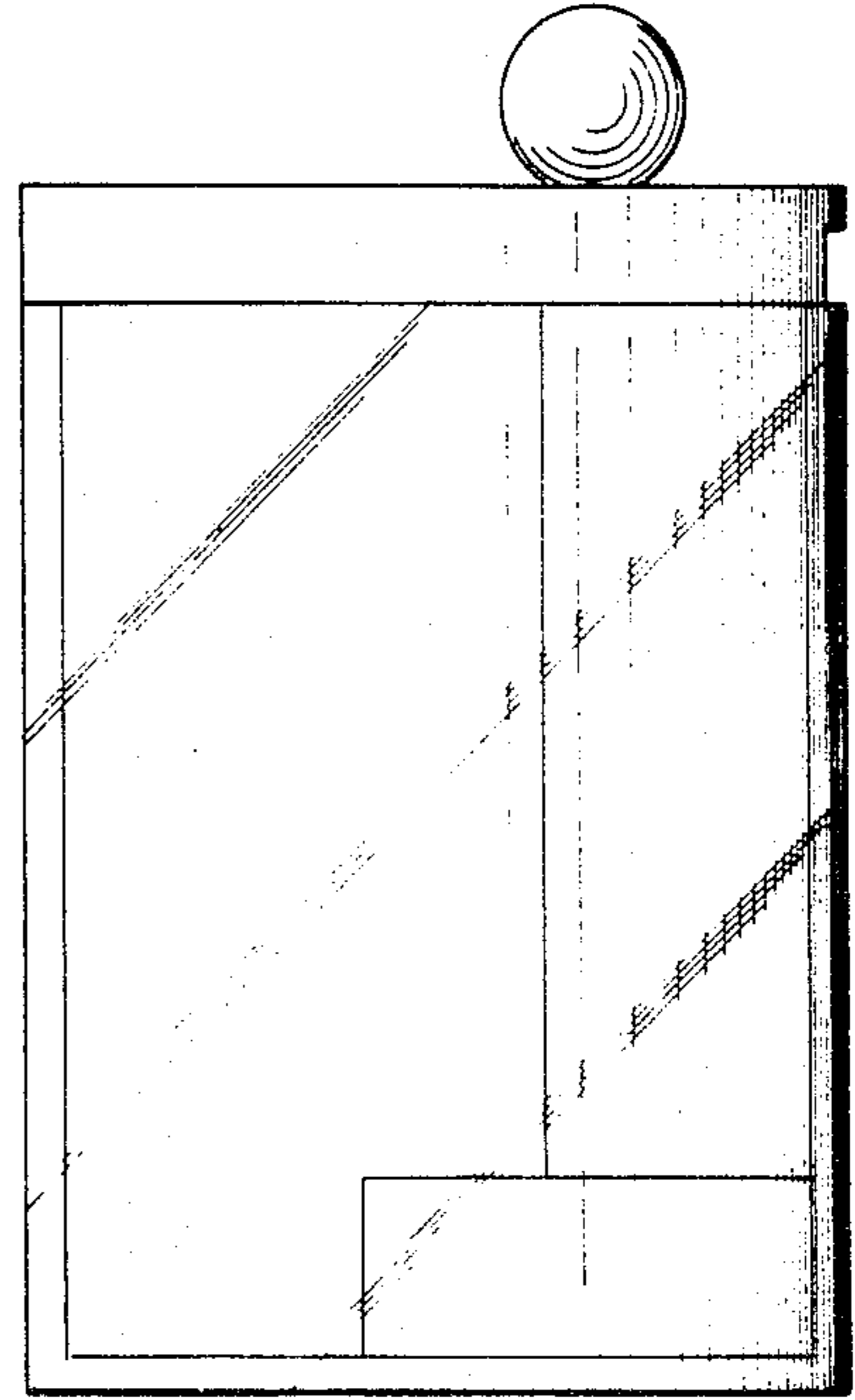

FIG. 6

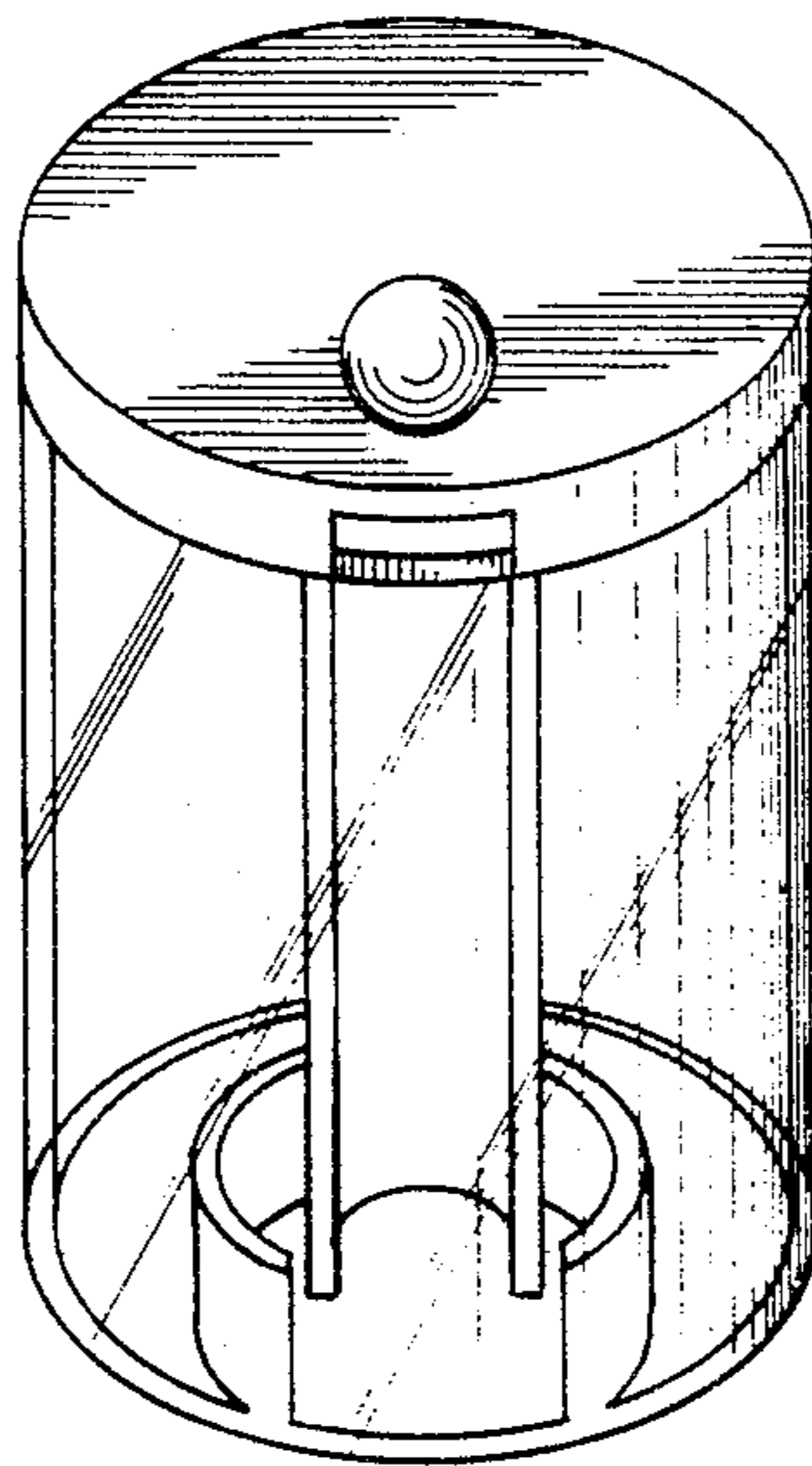

FIG. 7