

[54] LUGGAGE

[75] Inventors: John Pulichino; Harvey J. Bomes, both of Wellesey, Mass.; John J. Migliore, East Greenwich, R.I.; Lonnie M. Smith, Fort Smith, R.I.; Wayne Schmitt, Bristol, R.I.

[73] Assignee: American Tourister, Inc., Warren, R.I.

[**] Term: 14 Years

[21] Appl. No.: 356,595

[22] Filed: Mar. 9, 1982

[52] U.S. Cl. D3/71; D3/77

[58] Field of Search D3/30.1, 35, 71, 74, D3/76, 77; 150/1; 190/41 R, 412, 52

[56] References Cited

U.S. PATENT DOCUMENTS

D. 247,655	3/1978	Koffler	D3/71
D. 252,175	6/1979	Koffler	D3/71
D. 263,177	3/1982	Gibbs	D3/71
D. 265,439	7/1982	Stark	D3/71
D. 266,032	9/1982	Stark	D3/71

Primary Examiner—George P. Word

Attorney, Agent, or Firm—Burns, Doane, Swecker & Mathis

[57] CLAIM

The ornamental design for luggage, substantially as shown and described.

DESCRIPTION

FIG. 1 is a front elevational view of luggage showing our new design;
 FIG. 2 is a rear elevational view thereof;
 FIG. 3 is a top plan view thereof;
 FIG. 4 is a bottom plan view thereof;
 FIG. 5 is a front elevational view of a second embodiment of the luggage;
 FIG. 6 is a rear elevational view thereof;
 FIG. 7 is a top plan view thereof;
 FIG. 8 is a bottom plan view thereof;
 FIG. 9 is an alternate rear elevational view of the embodiment shown in FIG. 5;
 FIG. 10 is a right-side elevational view of FIG. 5;
 FIG. 11 is a left-side elevational view of FIG. 5;
 FIG. 12 is a front elevational view of another embodiment of the luggage;
 FIG. 13 is a rear elevational view thereof;
 FIG. 14 is a left-side elevational view of FIG. 12;
 FIG. 15 is a right-side elevational view thereof;
 FIG. 16 is a top plan view thereof; and
 FIG. 17 is a bottom plan view thereof.

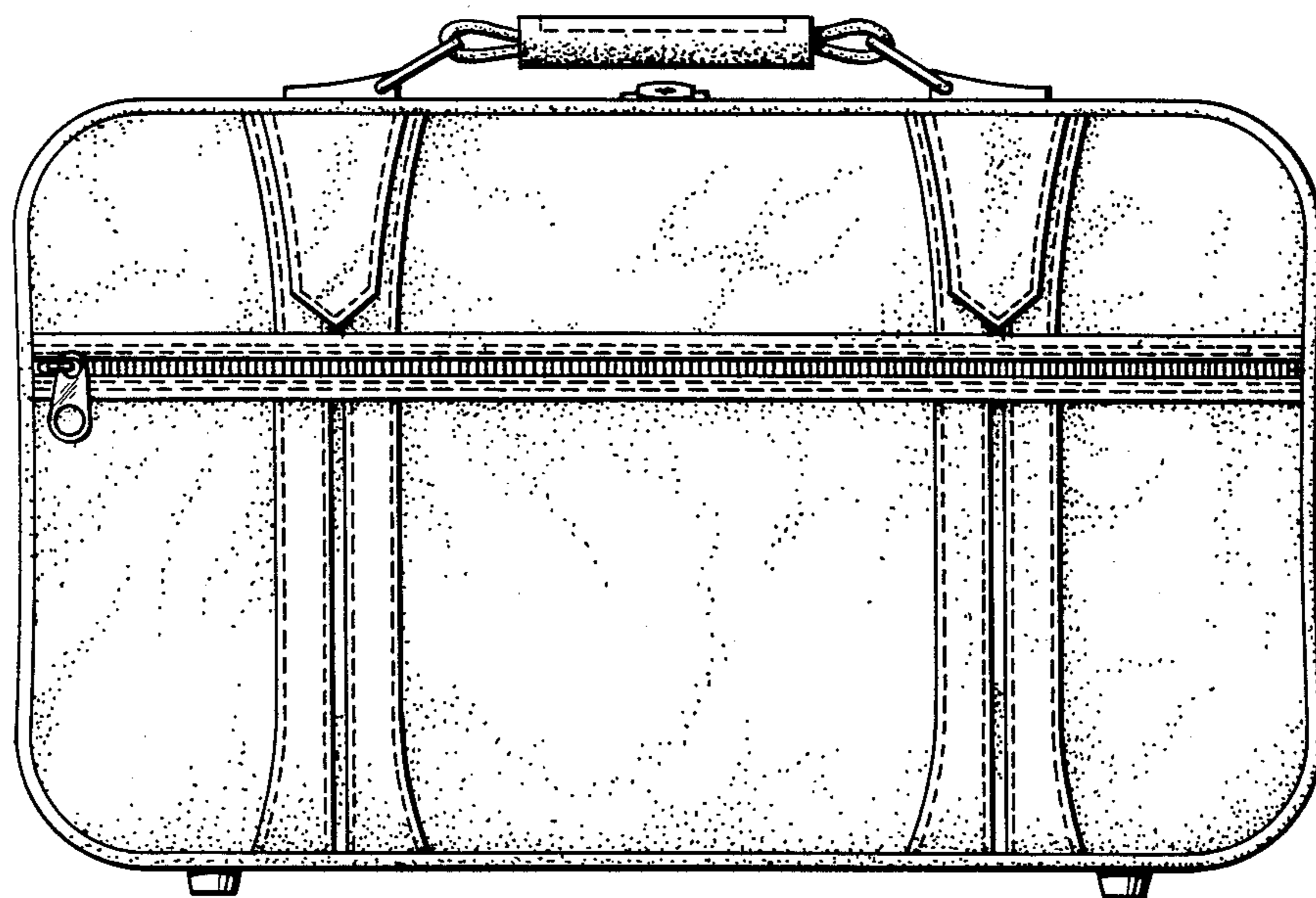

Fig. 1

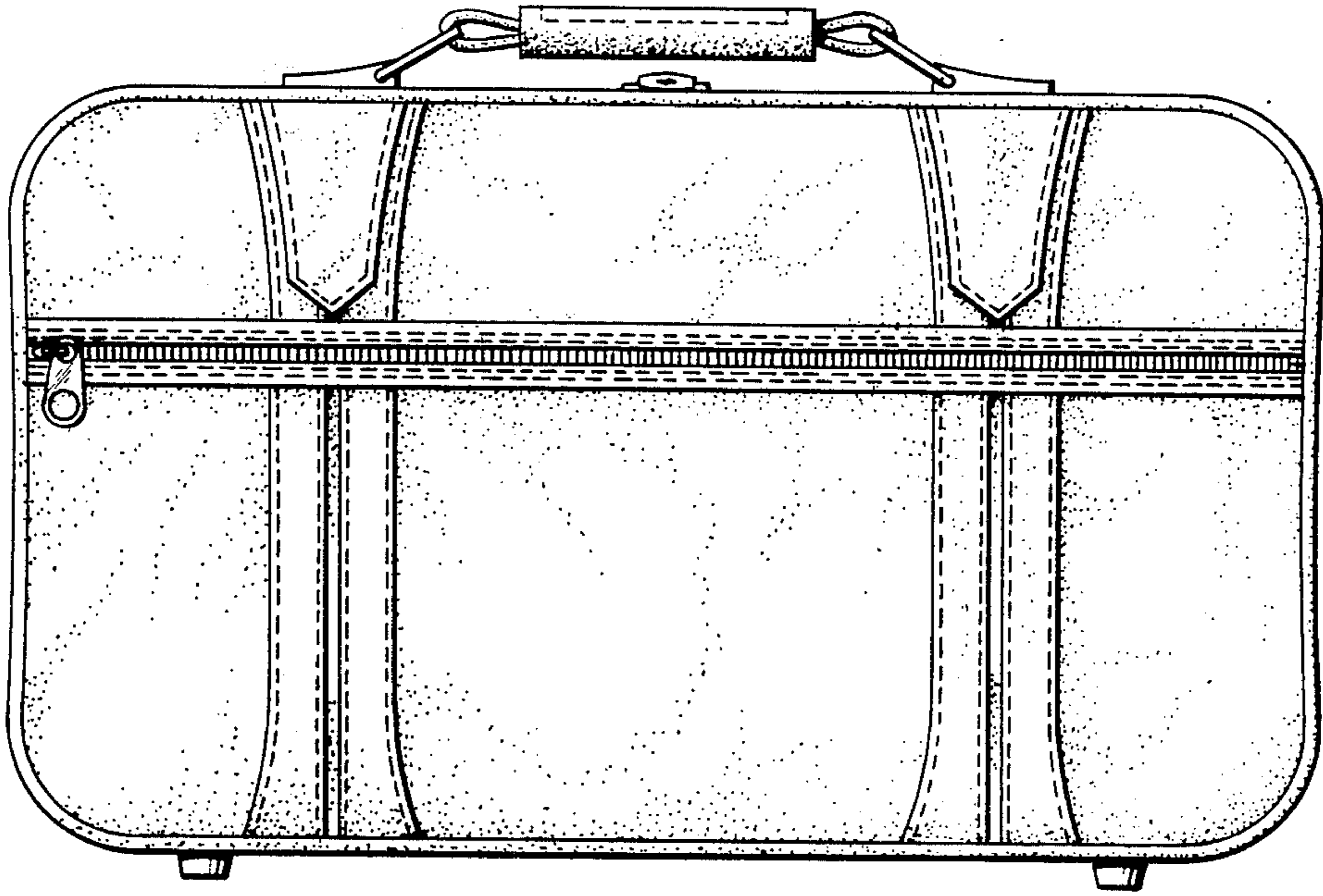

Fig. 2

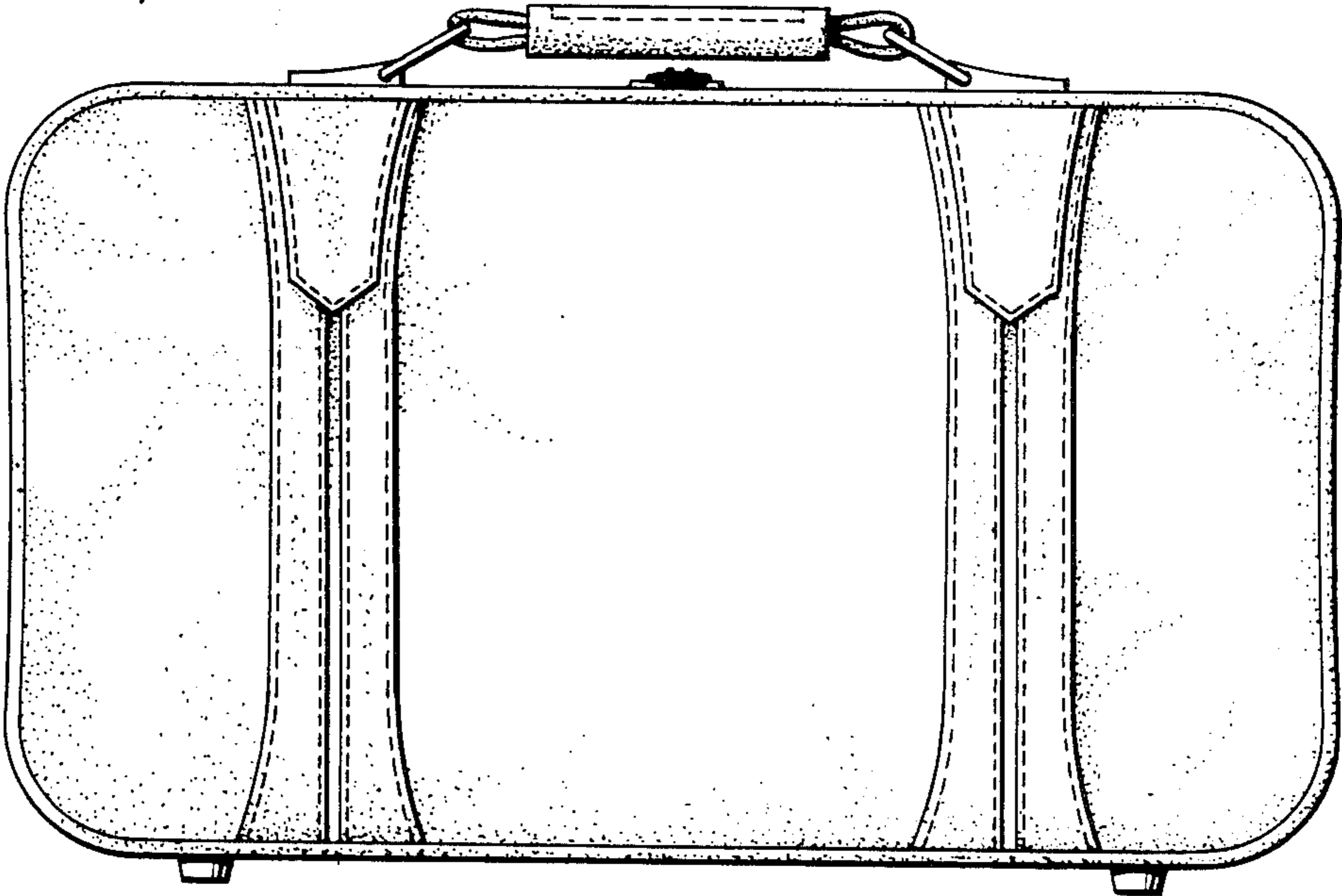

FIG. 3

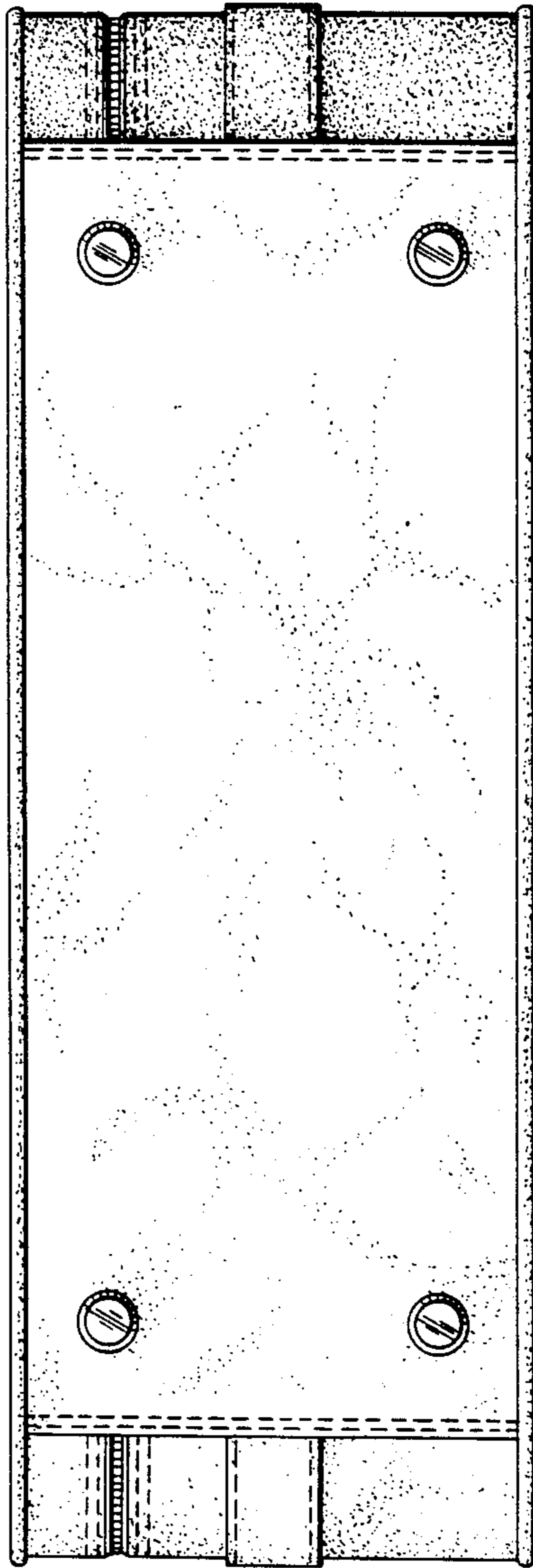
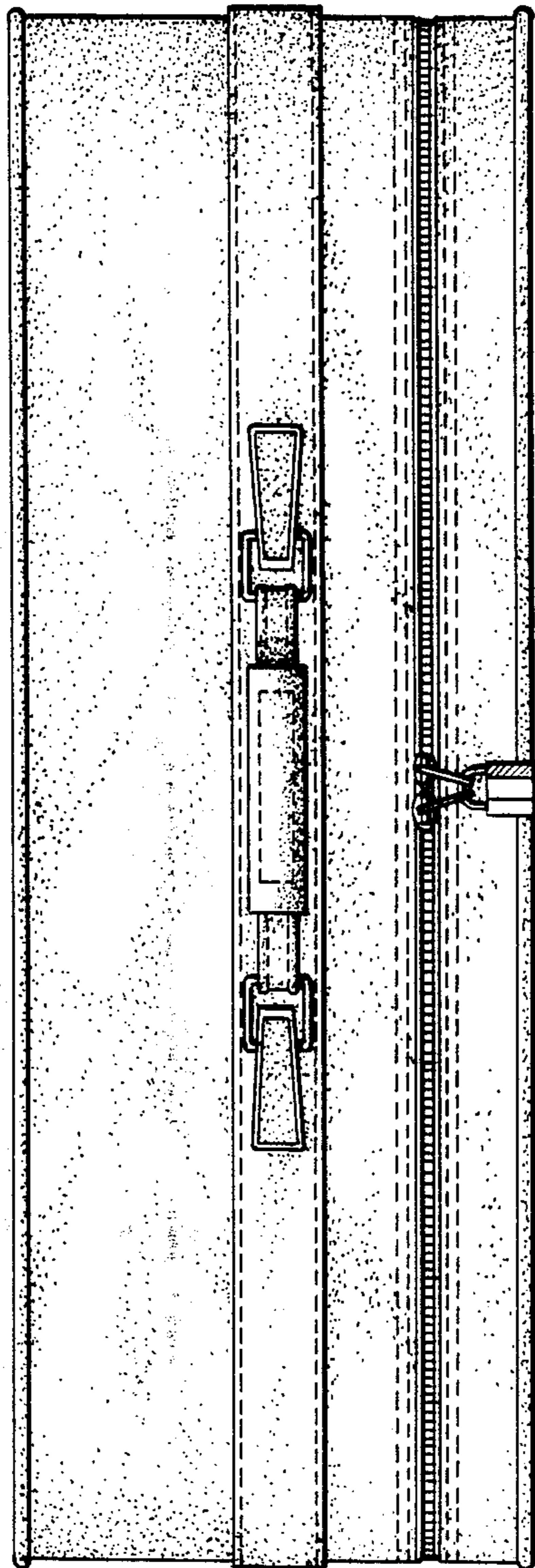

FIG. 4

FIG. 5

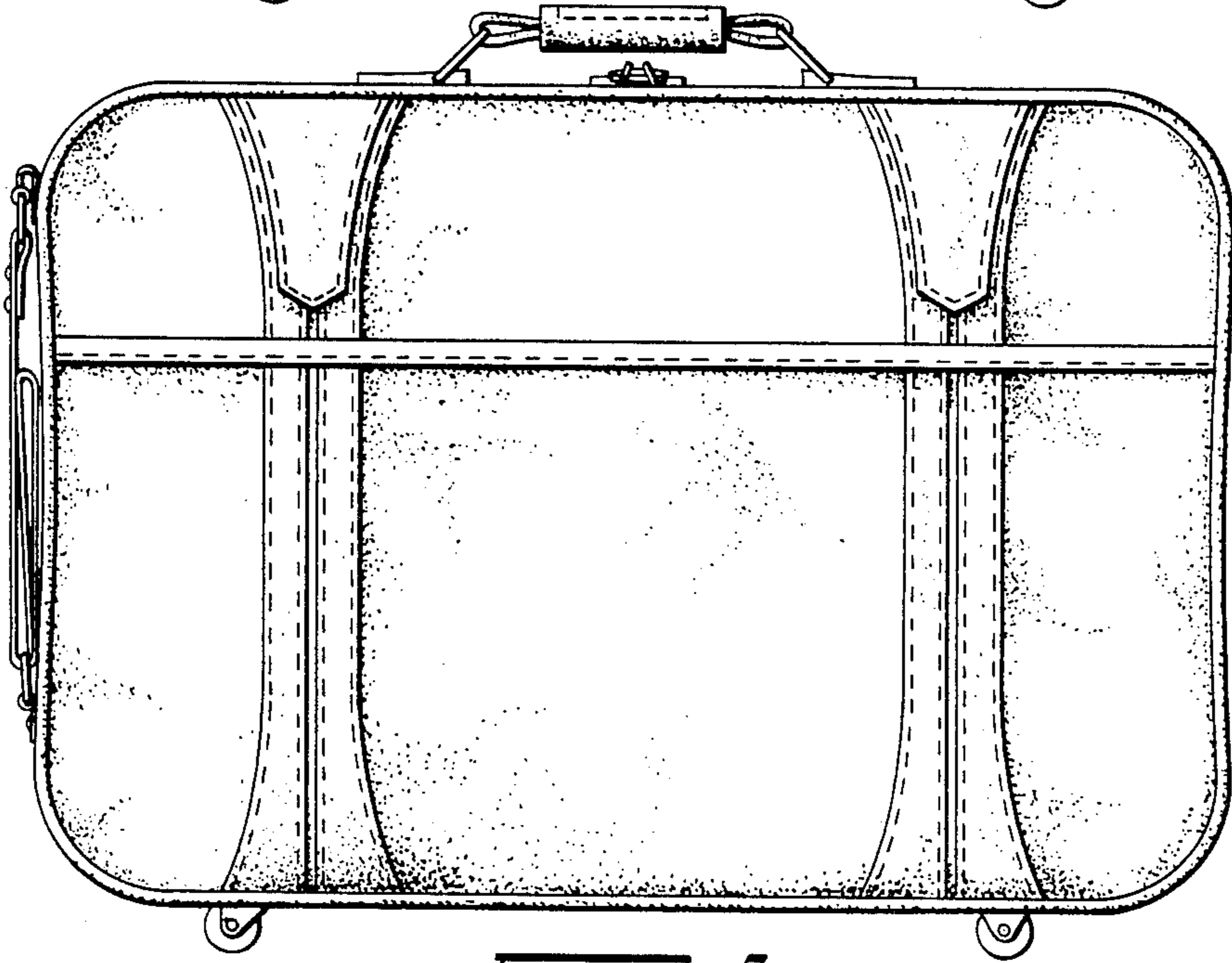
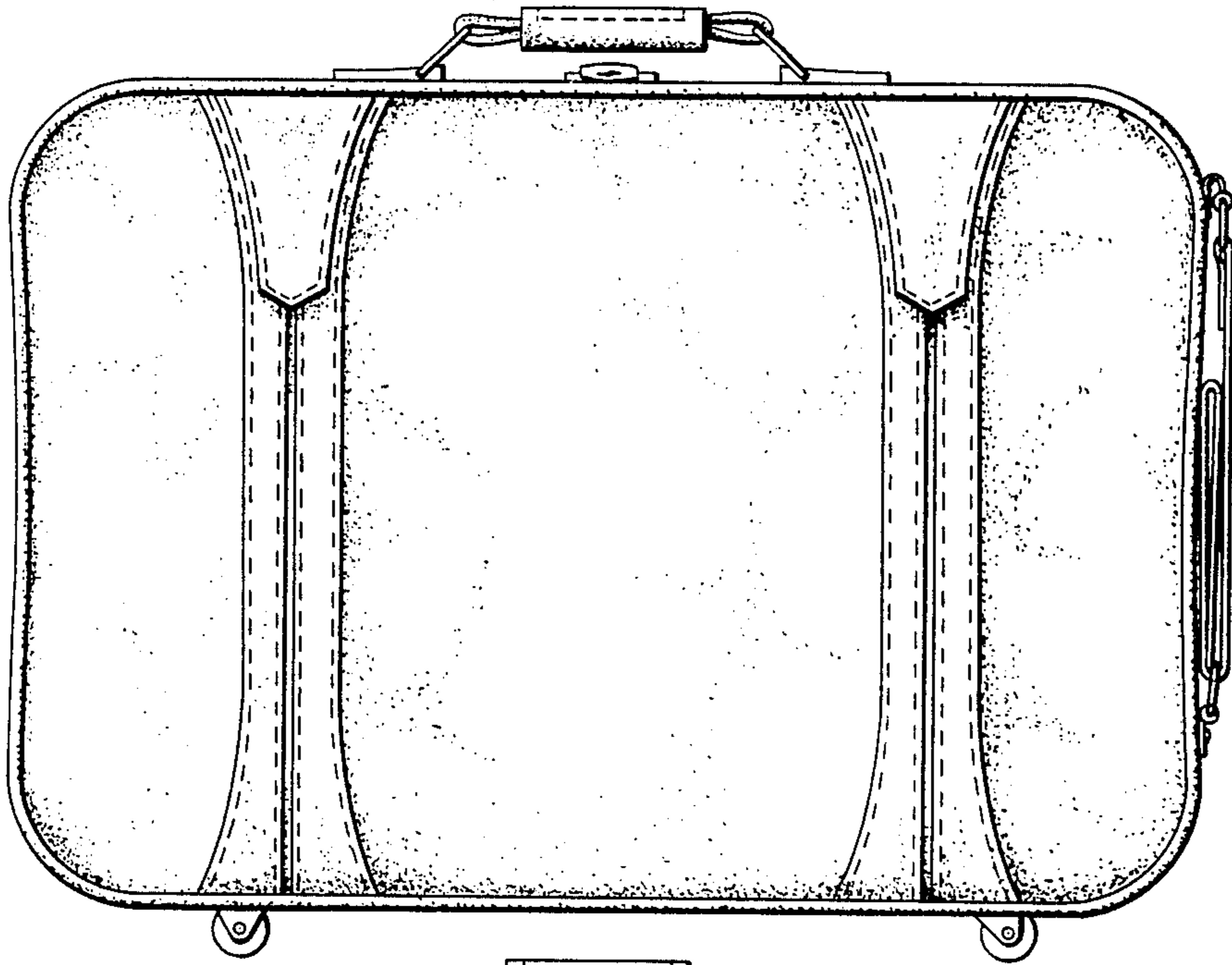

FIG. 6

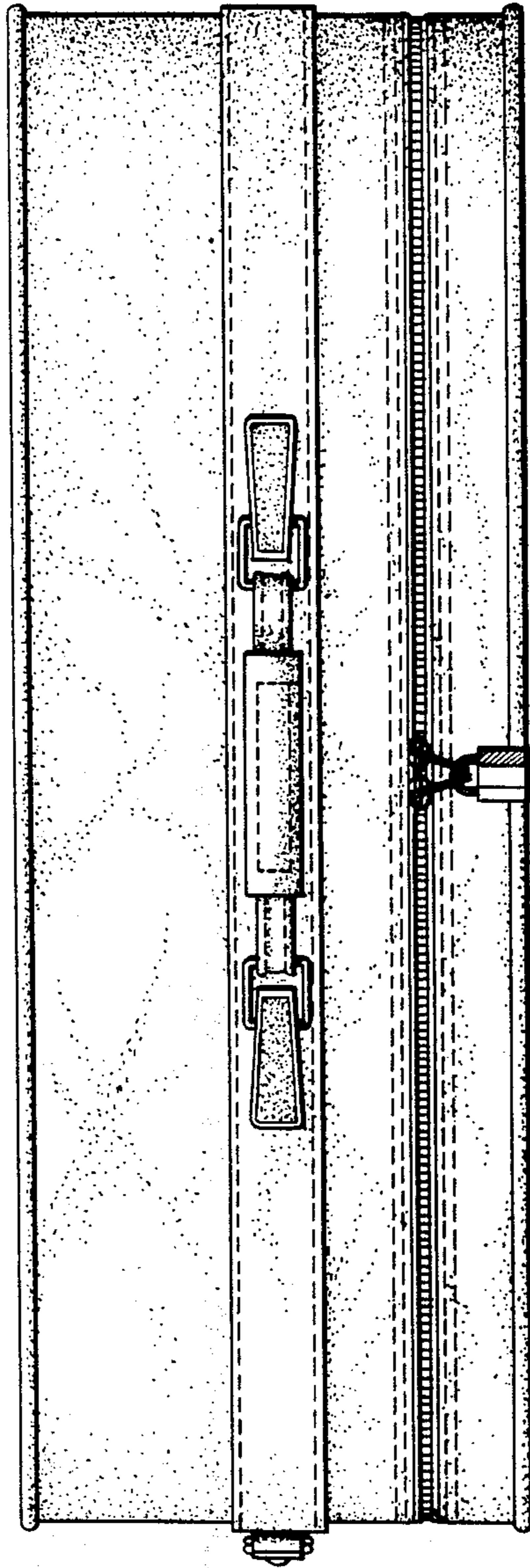

FIG. 1

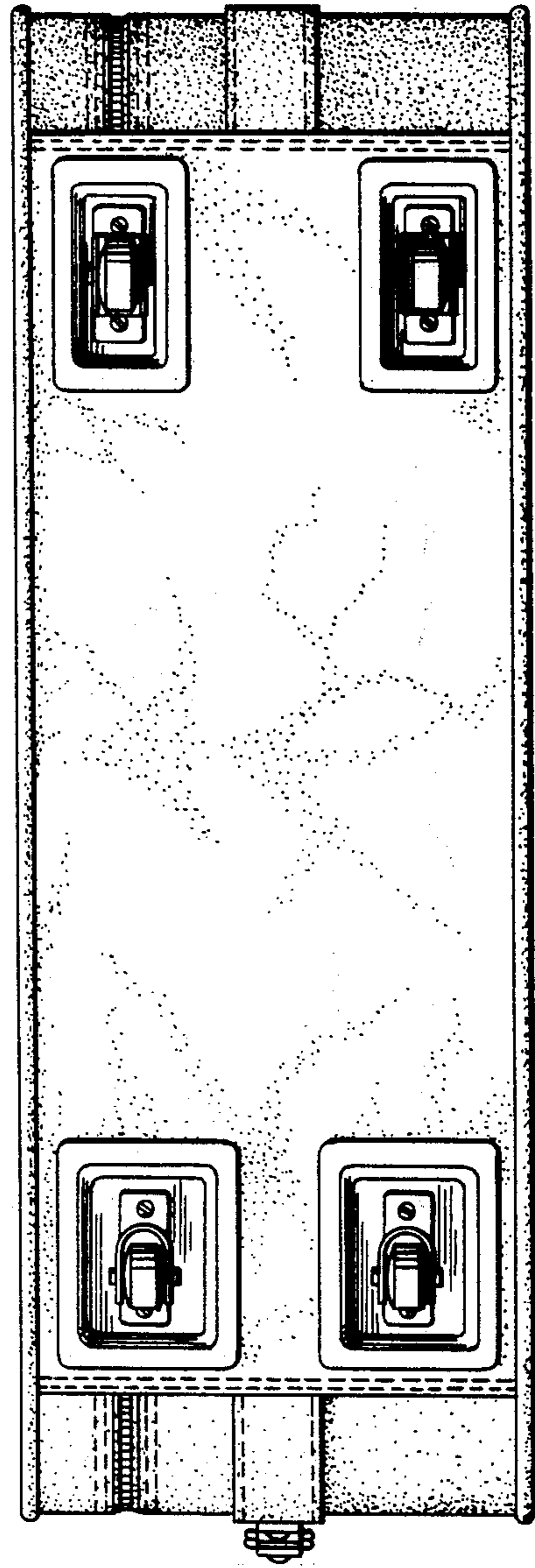

FIG. 2

Fig. 9

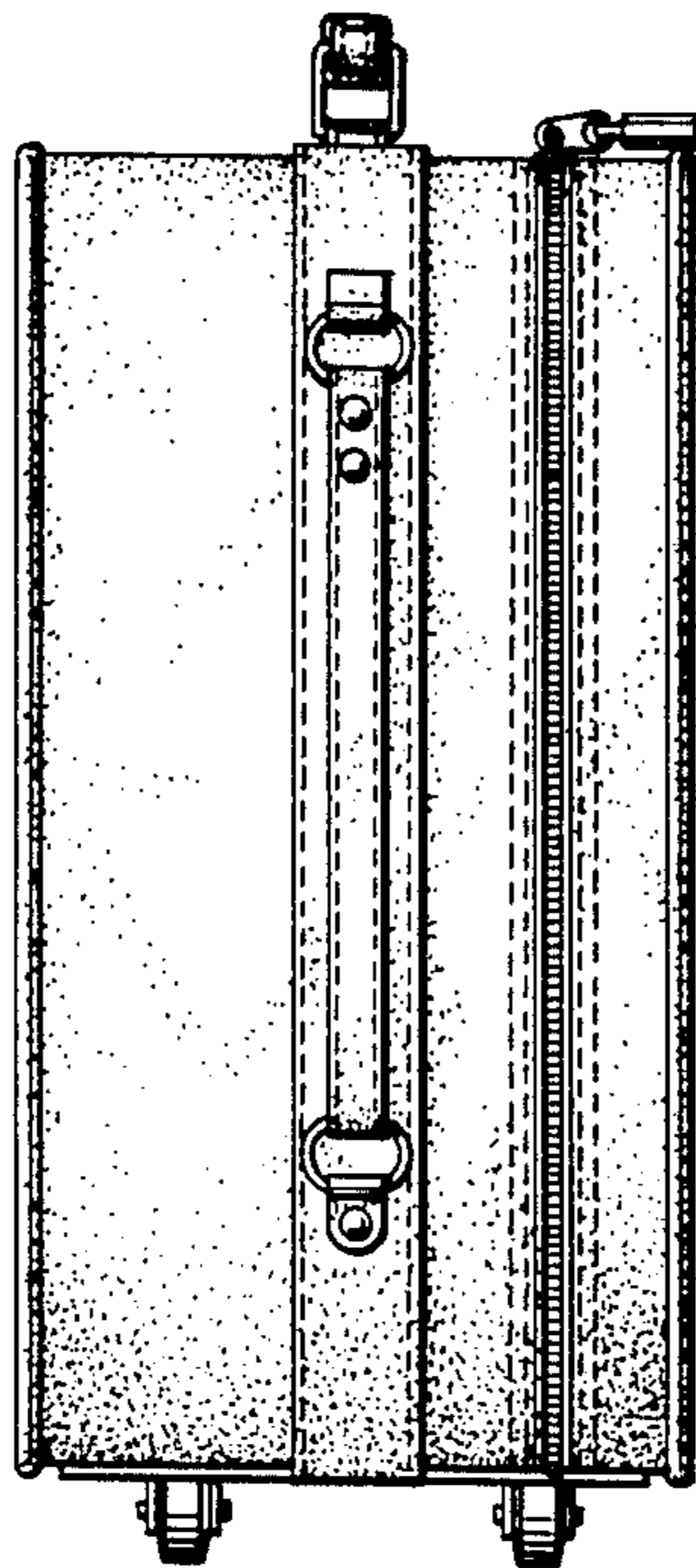
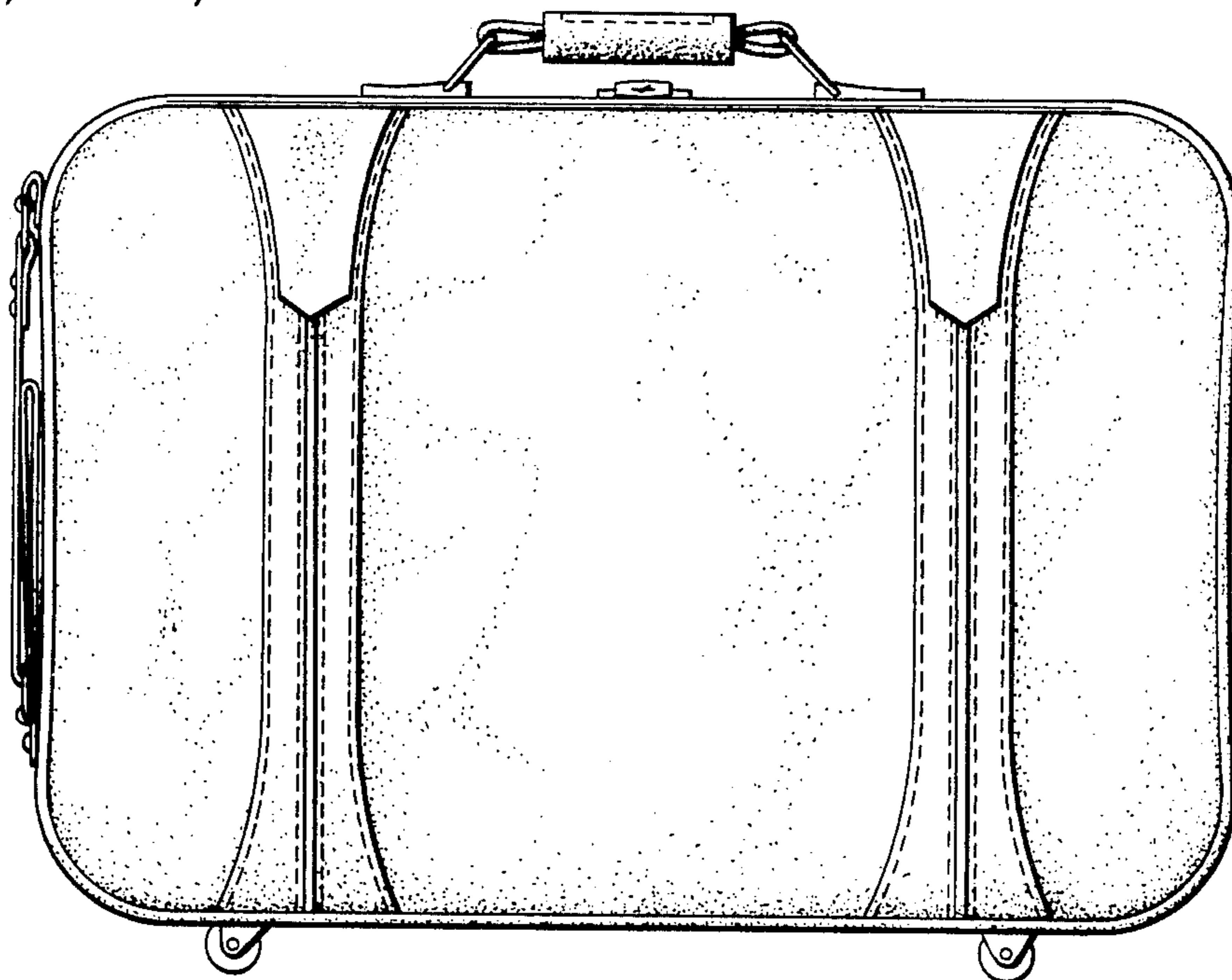

Fig. 10

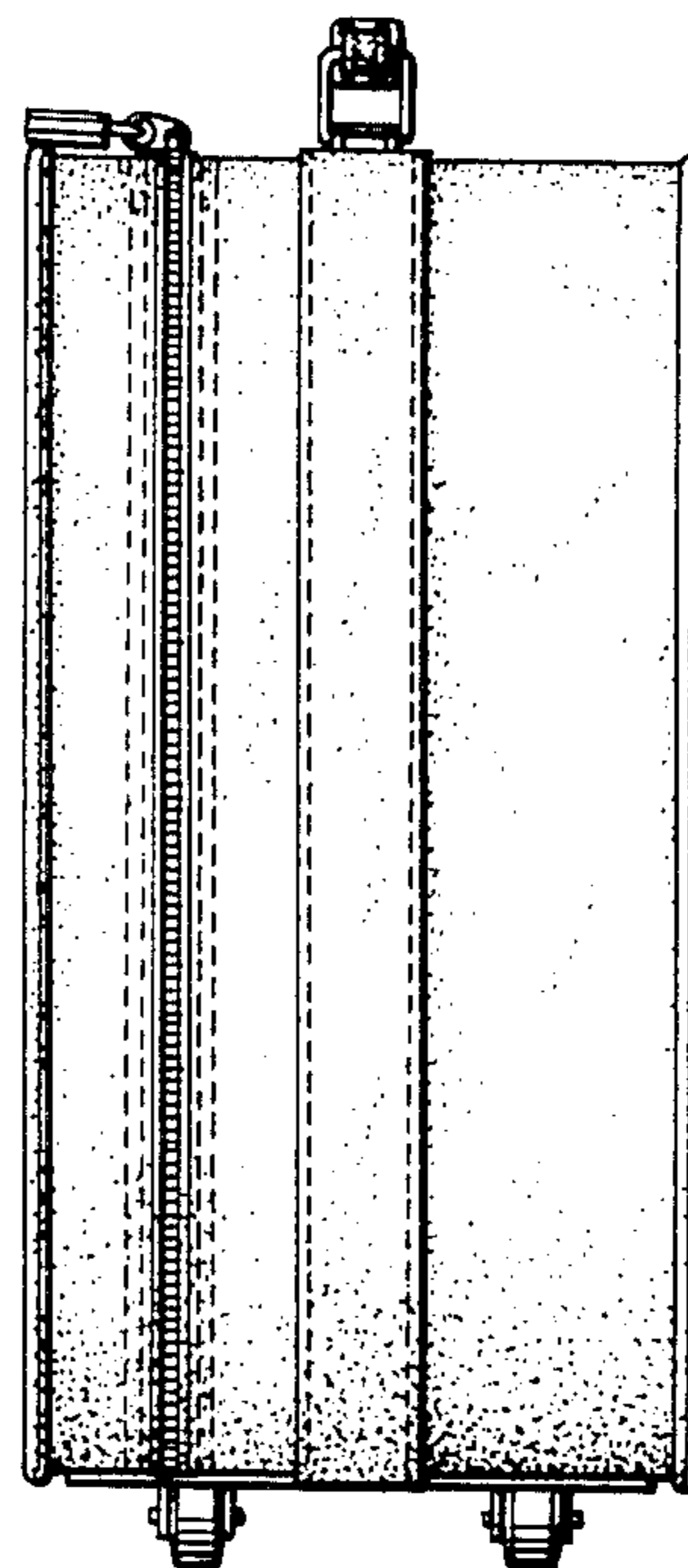

Fig. 11

FIG. 12

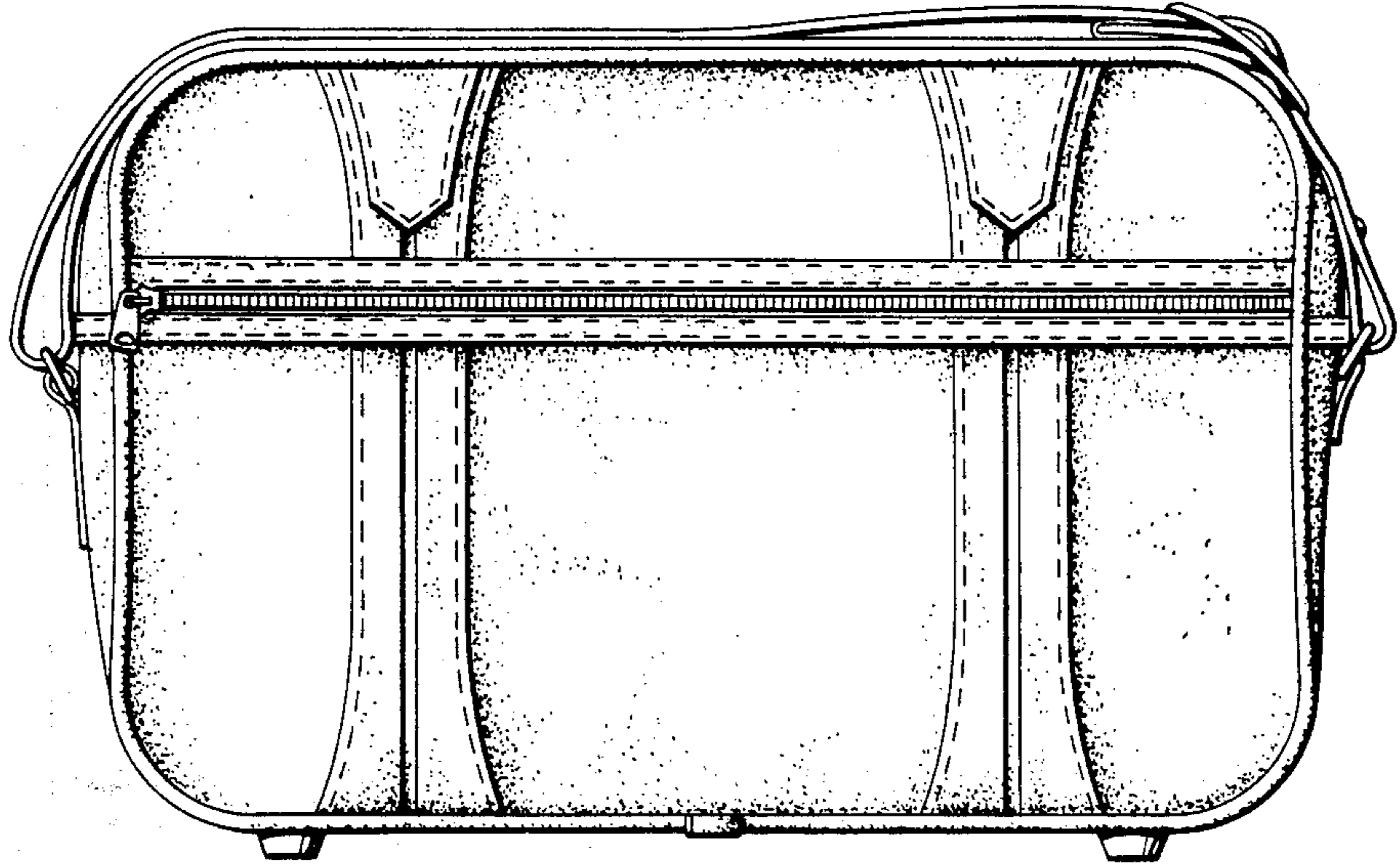

FIG. 13

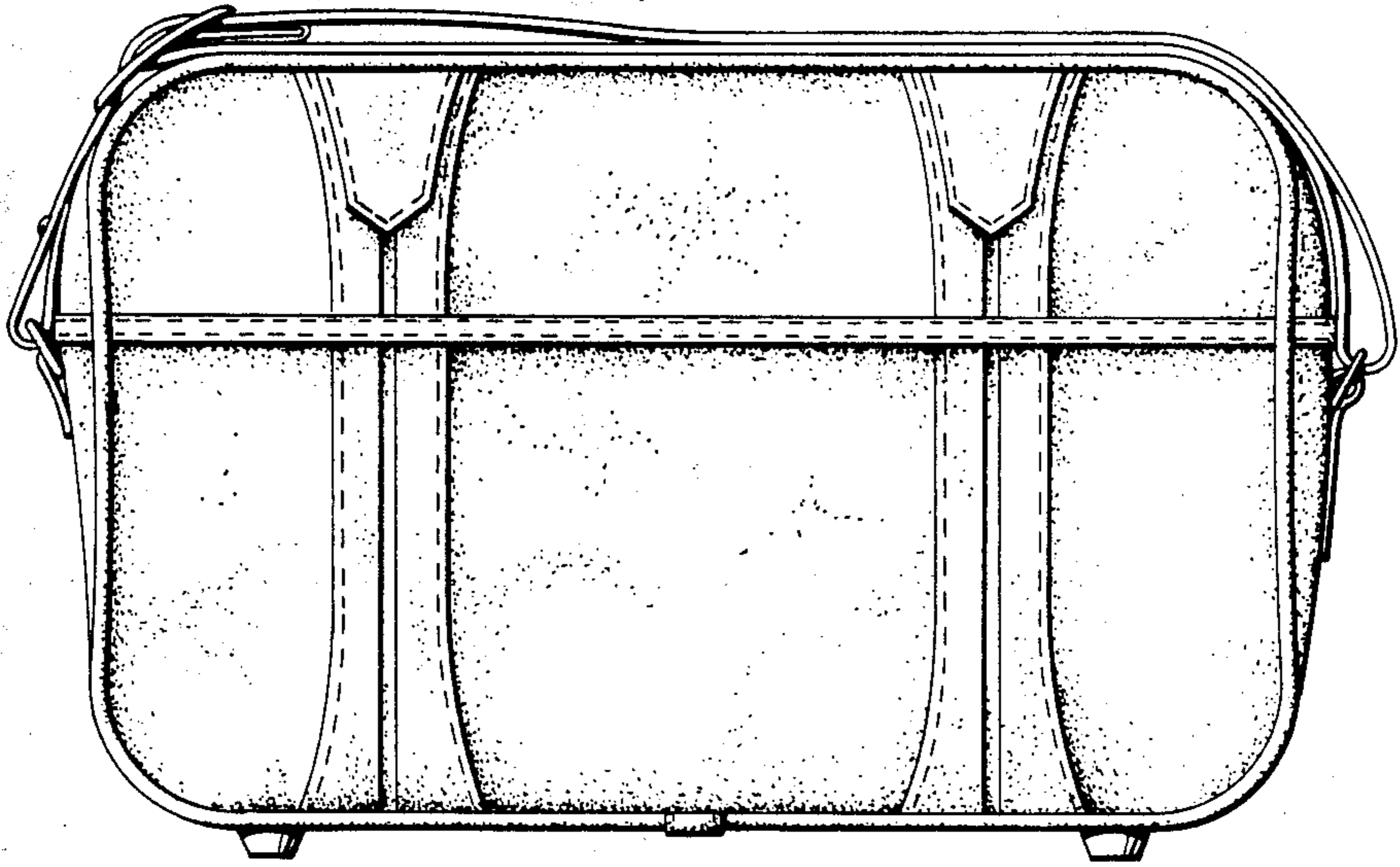

FIG. 14

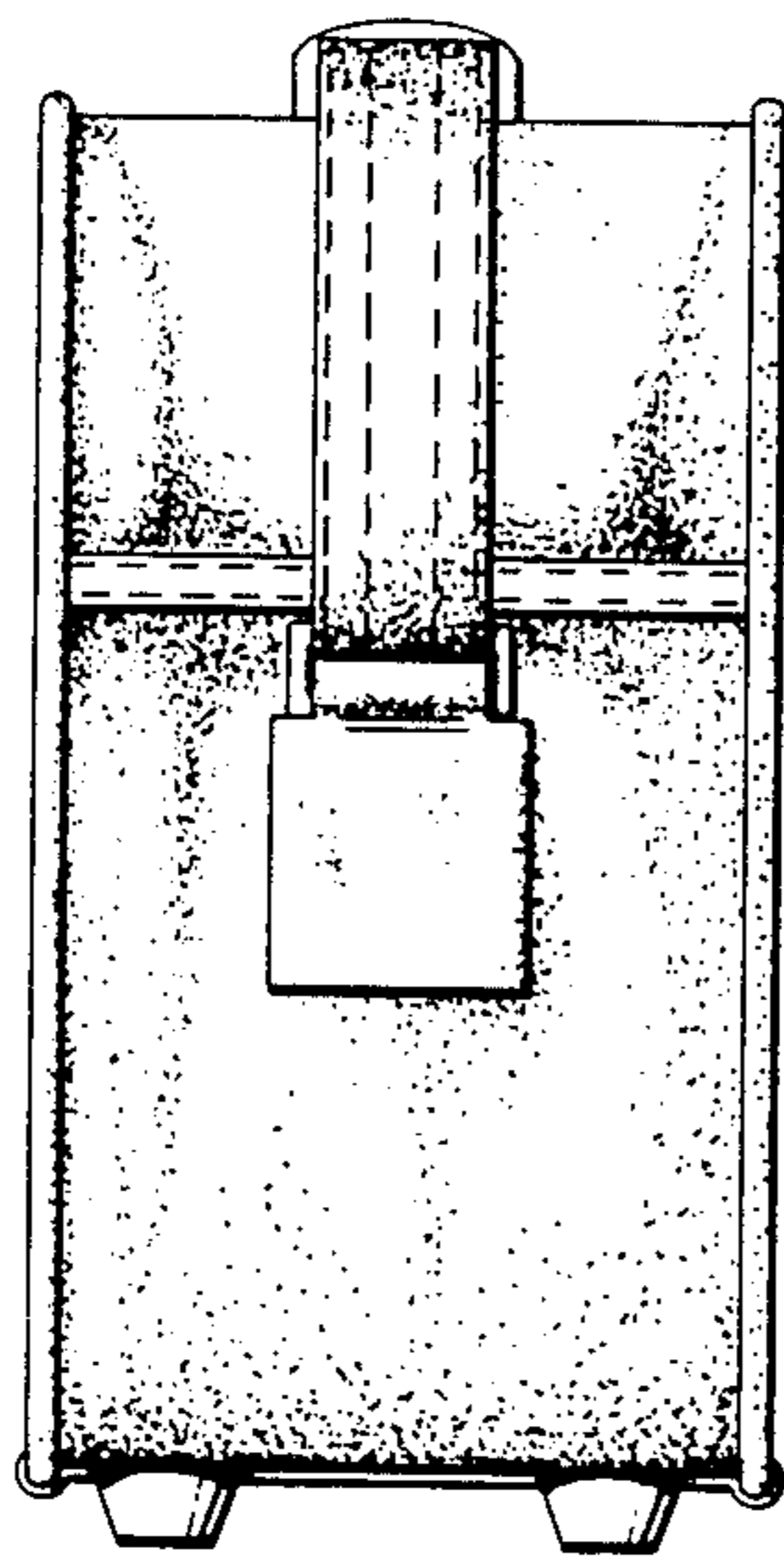

FIG. 15

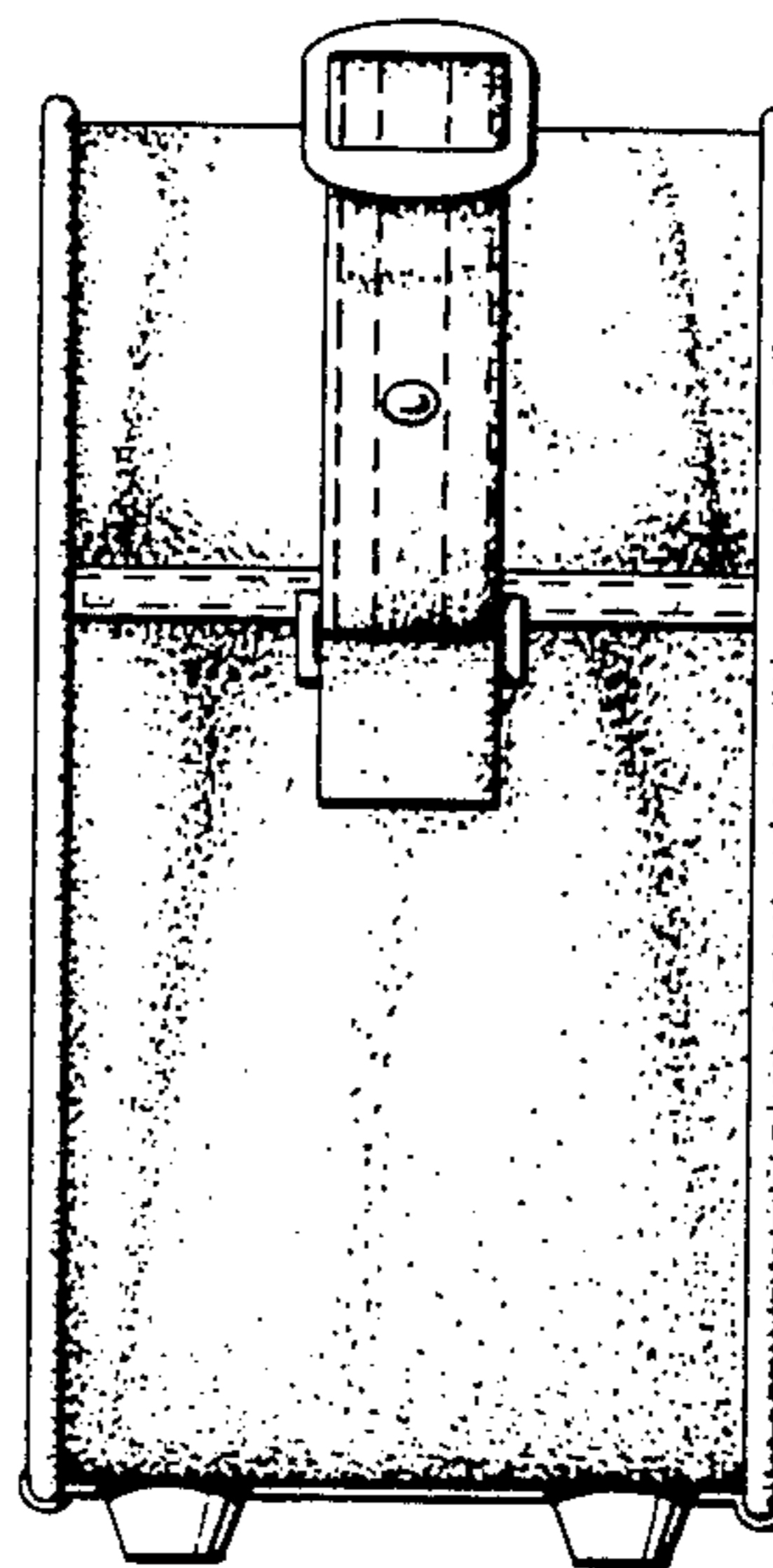

FIG. 16

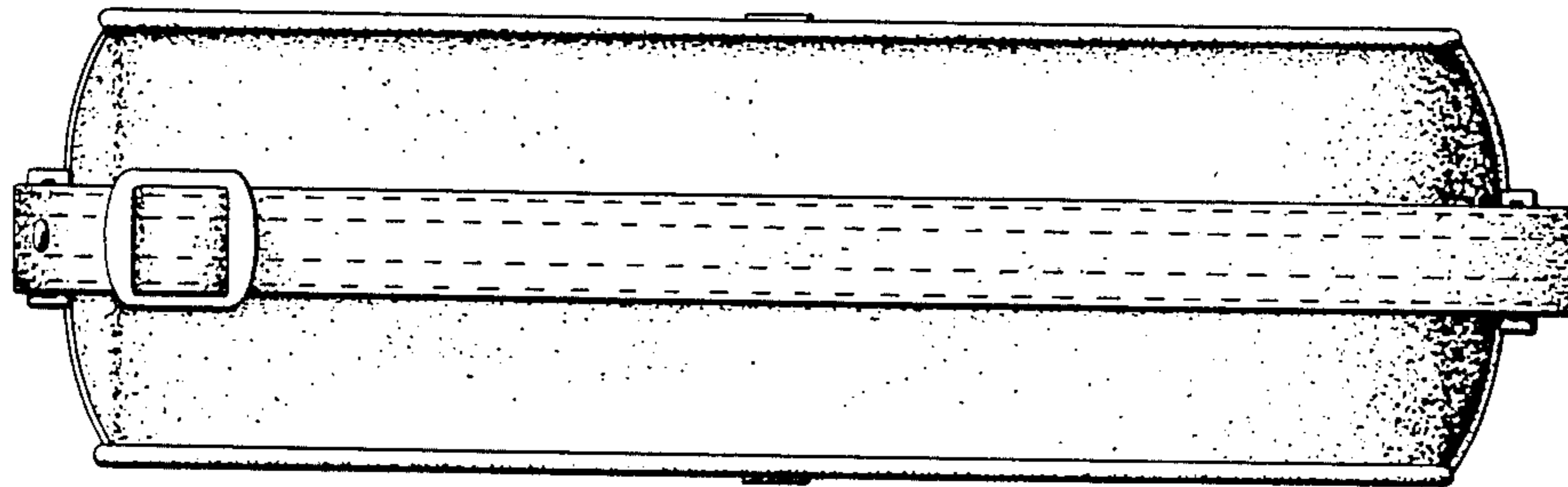

FIG. 17

