

[54] **HAT**

[76] **Inventor: George C. Sing, 12906 - 104A Ave.,
Surrey, British Columbia, Canada**

[**] **Term: 14 Years**

[21] **Appl. No.: 394,236**

[22] **Filed: Jul. 1, 1982**

[52] **U.S. Cl. D2/248; D2/250**

[58] **Field of Search D2/230, 244, 248, 250,
D2/252; 2/175, 171, 196, 197, 198, 199, 200,
195**

[56] **References Cited**

U.S. PATENT DOCUMENTS

D. 86,343 2/1932 Yourek D2/252
D. 257,184 10/1980 Peham D2/248

FOREIGN PATENT DOCUMENTS

48686 9/1981 Canada .

Primary Examiner—Carmen H. Vales
Attorney, Agent, or Firm—Fetherstonhaugh & Co.

[57] **CLAIM**

The ornamental design for a hat, substantially as shown.

DESCRIPTION

FIG. 1 is a top perspective view of a hat showing my new design;

FIG. 2 is a right side elevational view thereof;

FIG. 3 is a front elevational view thereof;

FIG. 4 is a rear elevational view thereof;

FIG. 5 is a top plan view thereof;

FIG. 6 is a left side elevational view thereof; and

FIG. 7 is a bottom plan view thereof.

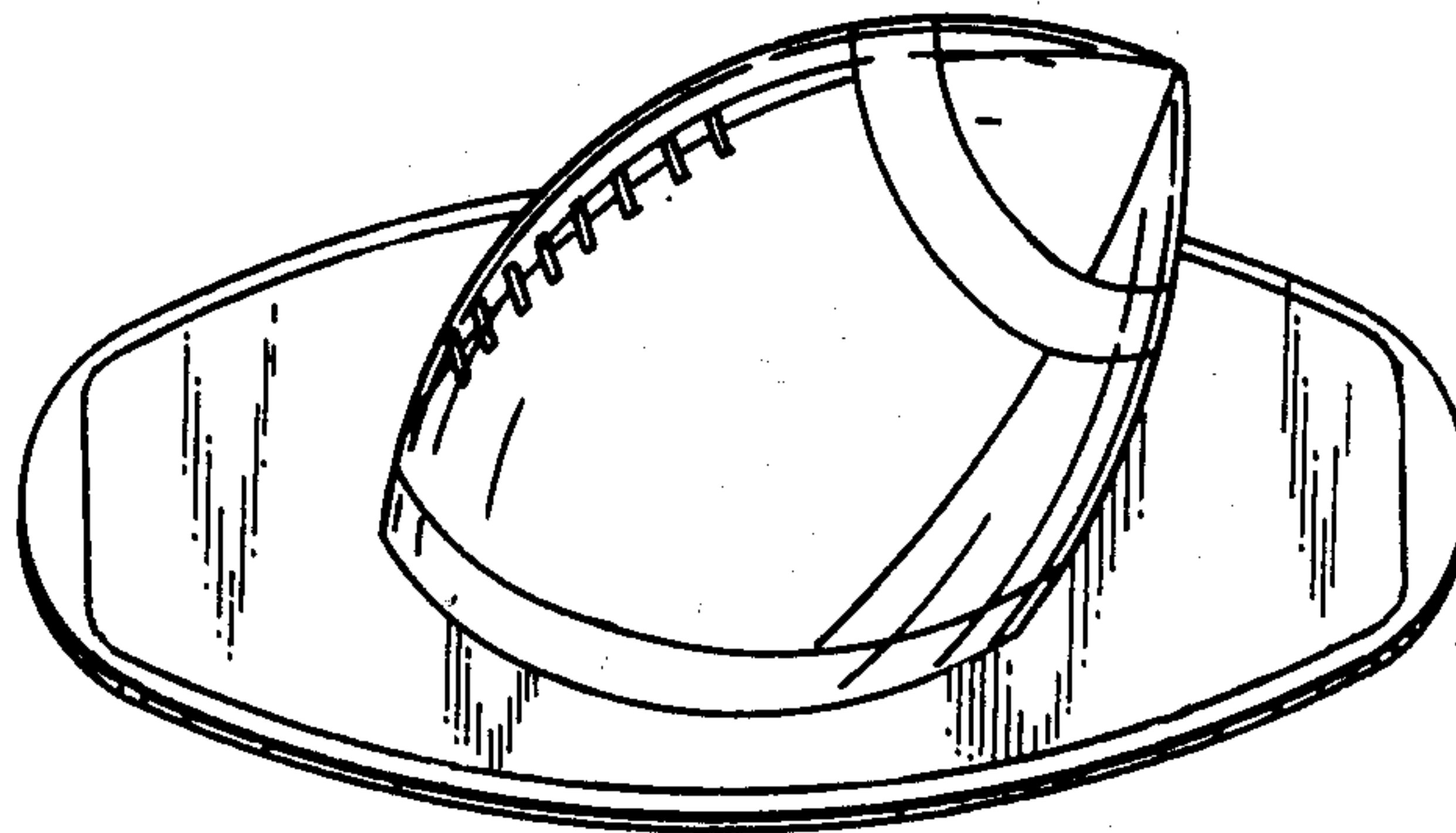

Fig. 1.

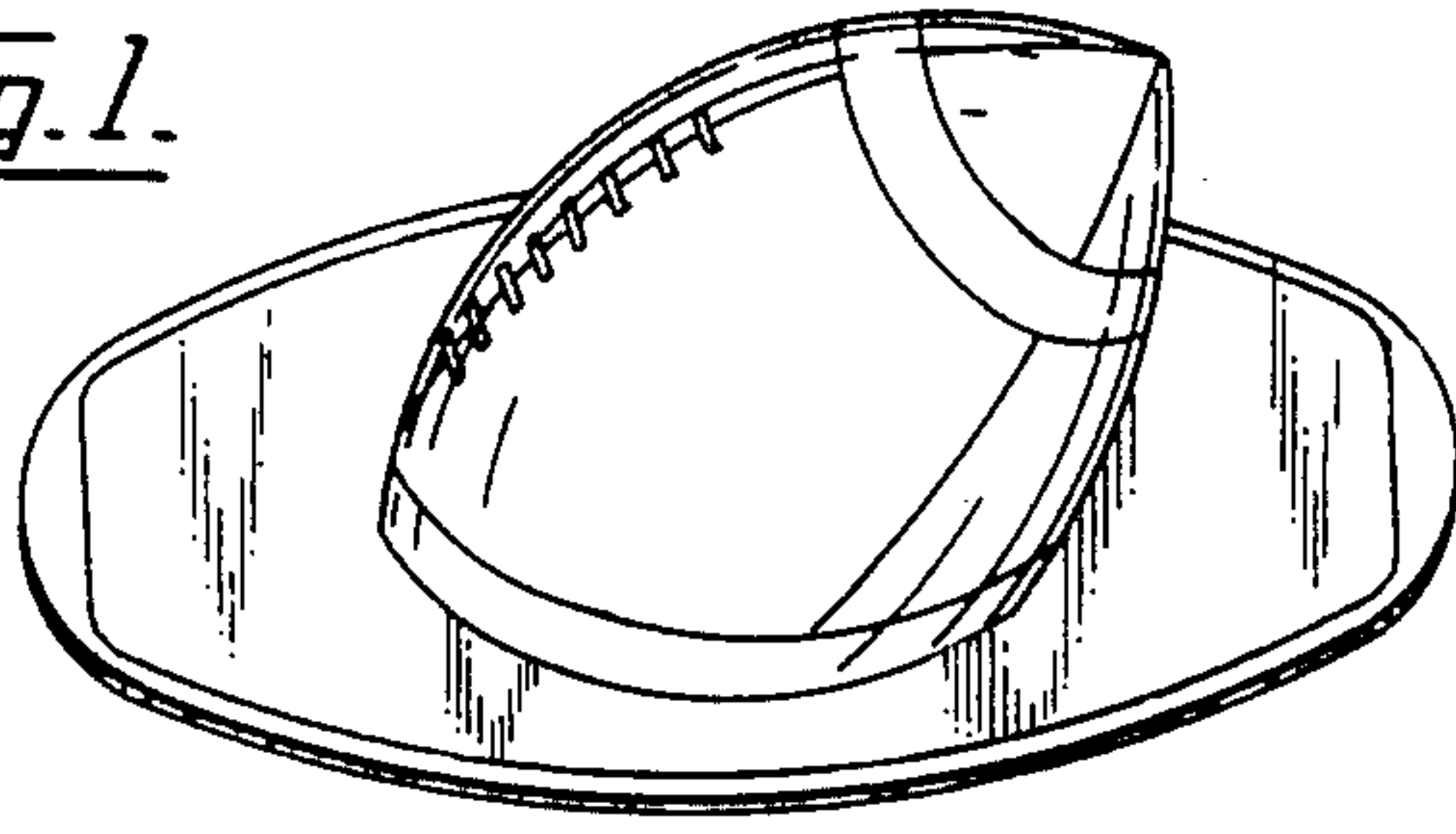

Fig. 2.

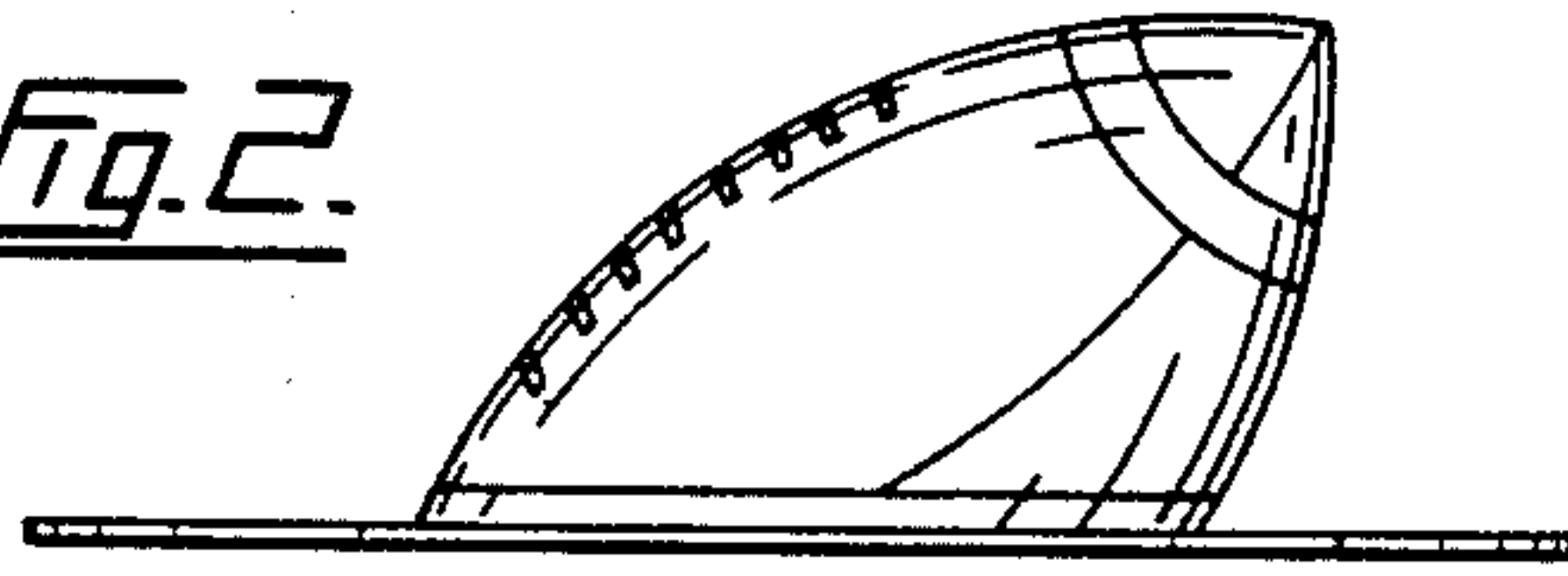

Fig. 3.

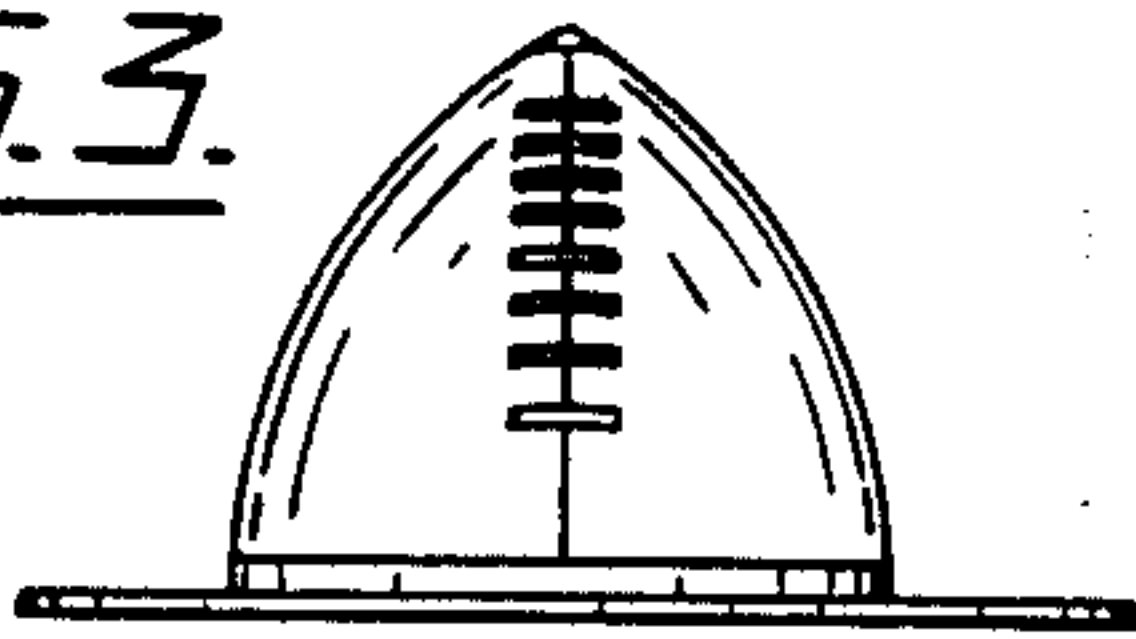

Fig. 4.

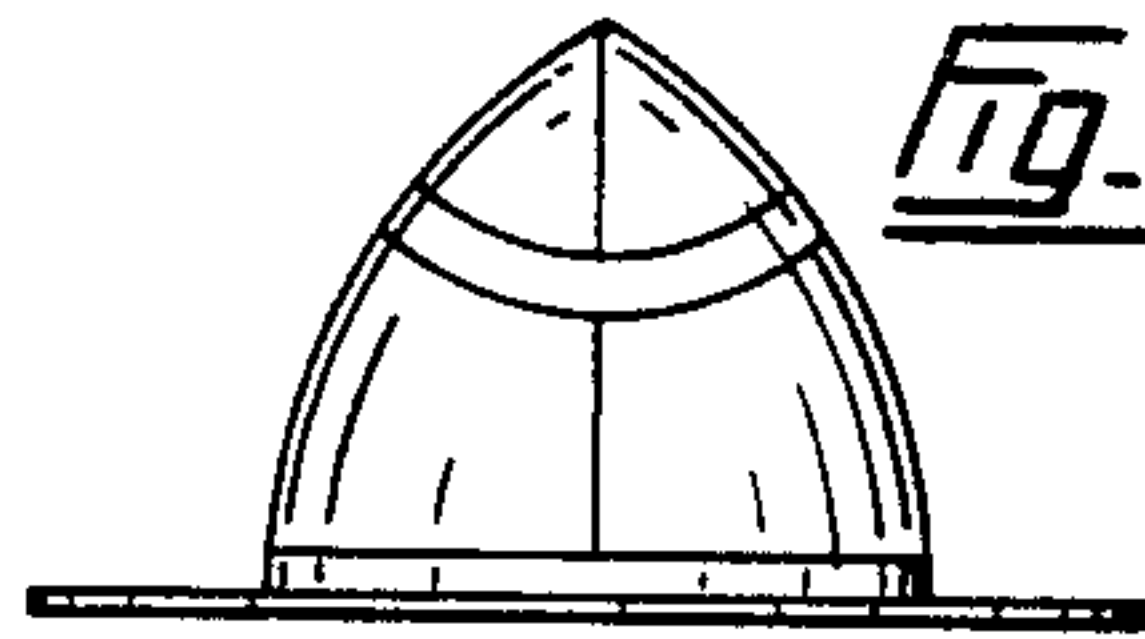

Fig. 5.

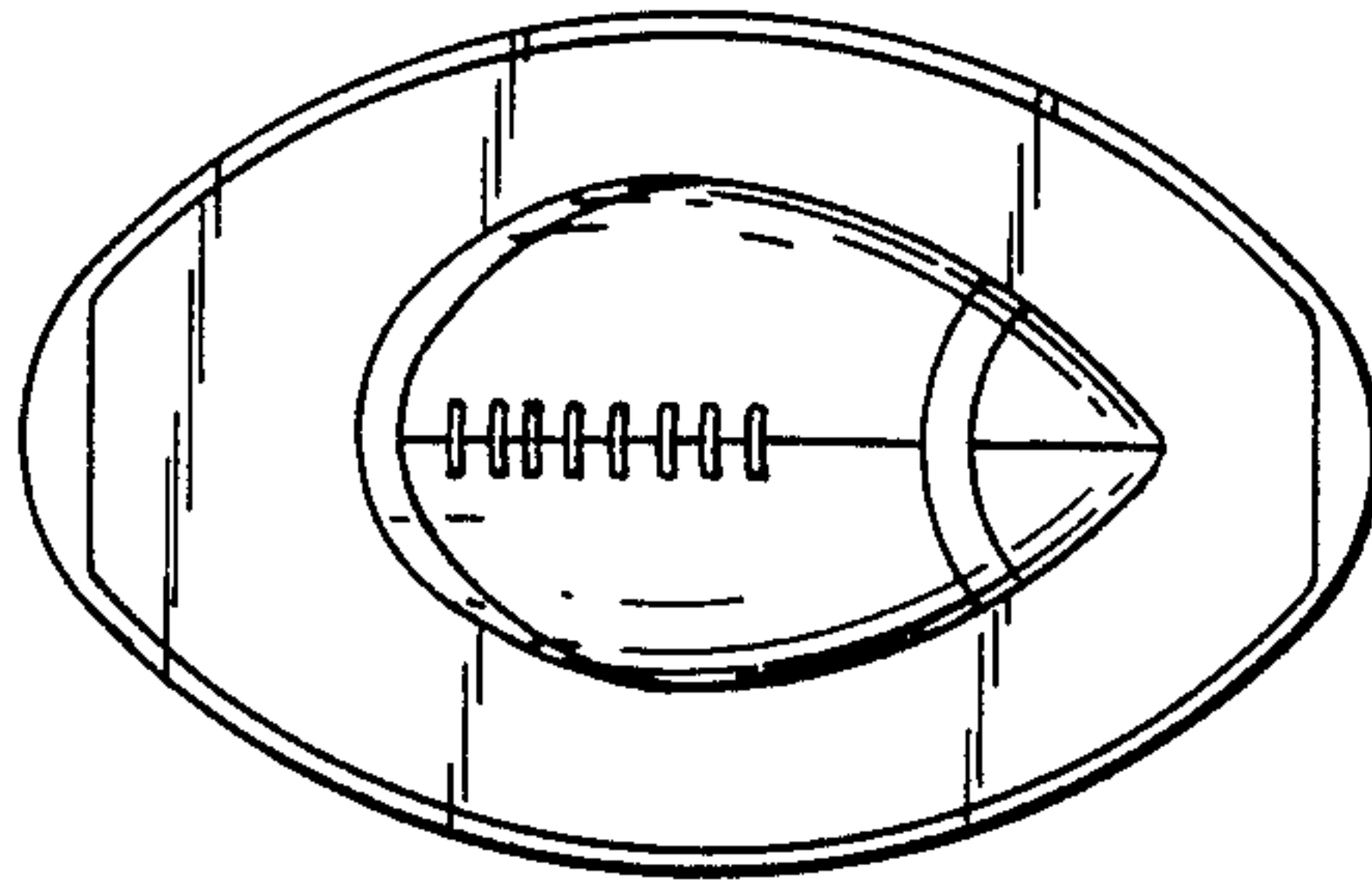

Fig. 6.

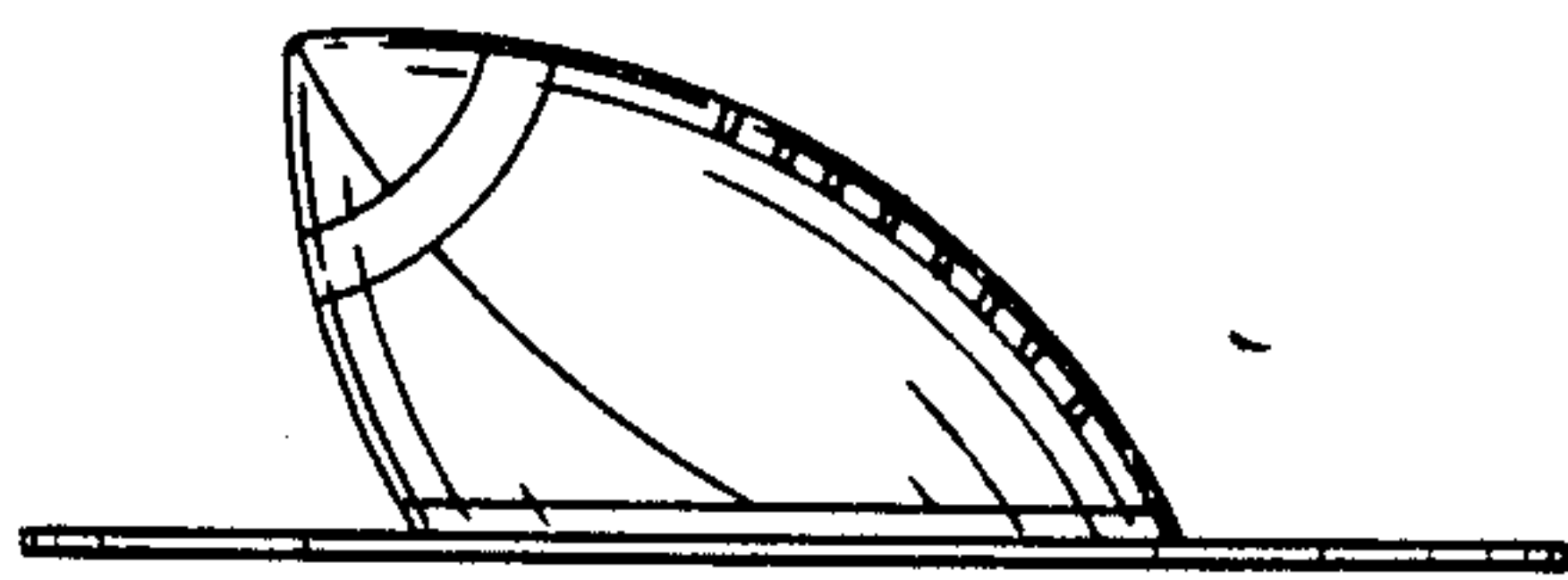

Fig. 7.

