

[54] DENTIST SERVICE UNIT

[75] Inventor: David E. J. Newman, Toronto, Canada

[73] Assignee: D.I. Retail Planning & Design Ltd., Toronto, Canada

[**] Term: 14 Years

[21] Appl. No.: 407,596

[22] Filed: Aug. 12, 1982

[30] Foreign Application Priority Data

Apr. 27, 1982 [CA] Canada 27-04-82-13

[52] U.S. Cl. D24/4; D6/432; D6/442

[58] Field of Search D6/157, 158, 159, 139, D6/167, 164, 168, 181, 169; D24/1, 4; 312/209, 279, 319, 328; 433/77, 79; 108/111

[56] References Cited

U.S. PATENT DOCUMENTS

- D. 216,312 12/1969 Levey D6/157
- D. 225,996 1/1973 Schwartz D24/4
- D. 227,106 6/1973 Webb et al. D24/4
- D. 267,340 12/1982 Watanabe D6/164 X

FOREIGN PATENT DOCUMENTS

886999 11/1971 Canada 433/77

OTHER PUBLICATIONS

"The Ambassador", by Scope Flyer, Dentist Service Unit on page.

Primary Examiner—Carmen H. Vales
Attorney, Agent, or Firm—Cushman, Darby & Cushman

[57] CLAIM

The ornamental design for a dentist service unit, as shown and described.

DESCRIPTION

FIG. 1 is a front perspective view of a dentist service unit showing my new design;
 FIG. 2 is a rear perspective view thereof;
 FIG. 3 is a front elevational view thereof;
 FIG. 4 is a top plan view thereof;
 FIG. 5 is a right side elevational view thereof;
 FIG. 6 is a left rear elevational view thereof;
 FIG. 7 is a rear elevational view thereof; and
 FIG. 8 is a front perspective view of another embodiment of the dentist service unit shown in FIG. 1; the rear and top plan views thereof being identical to those views shown in FIGS. 2, 4 and 6.

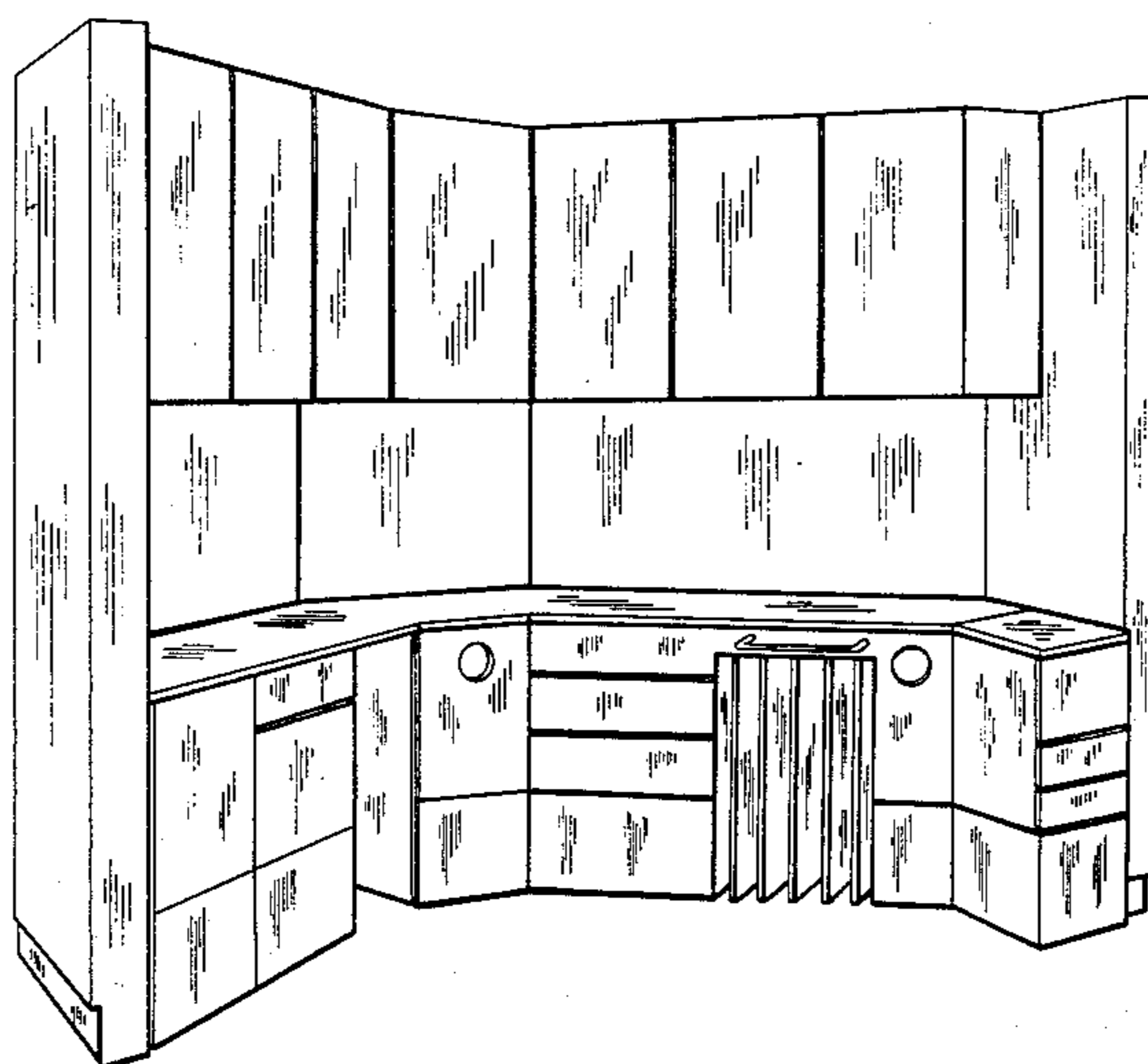

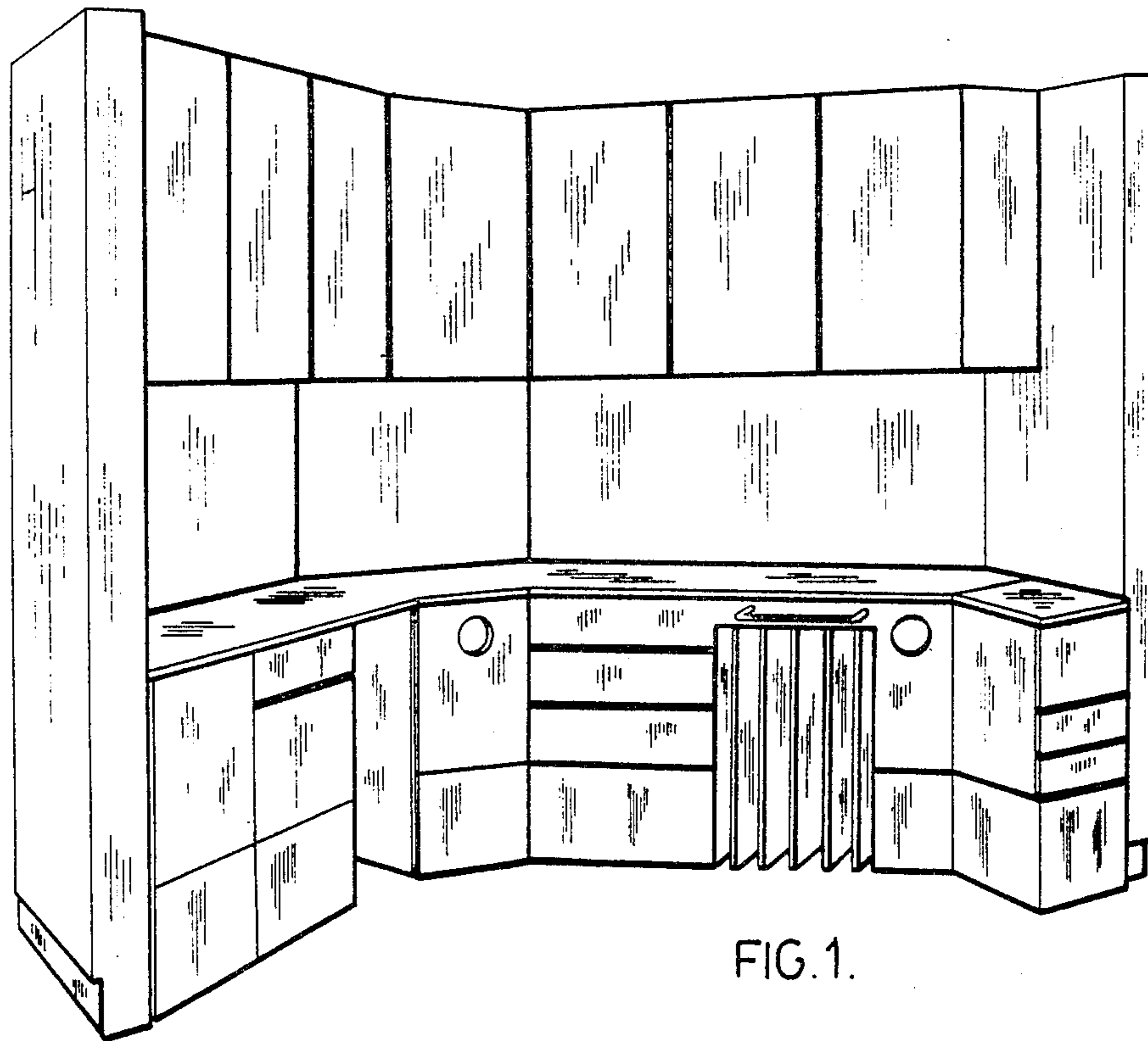

FIG. 1.

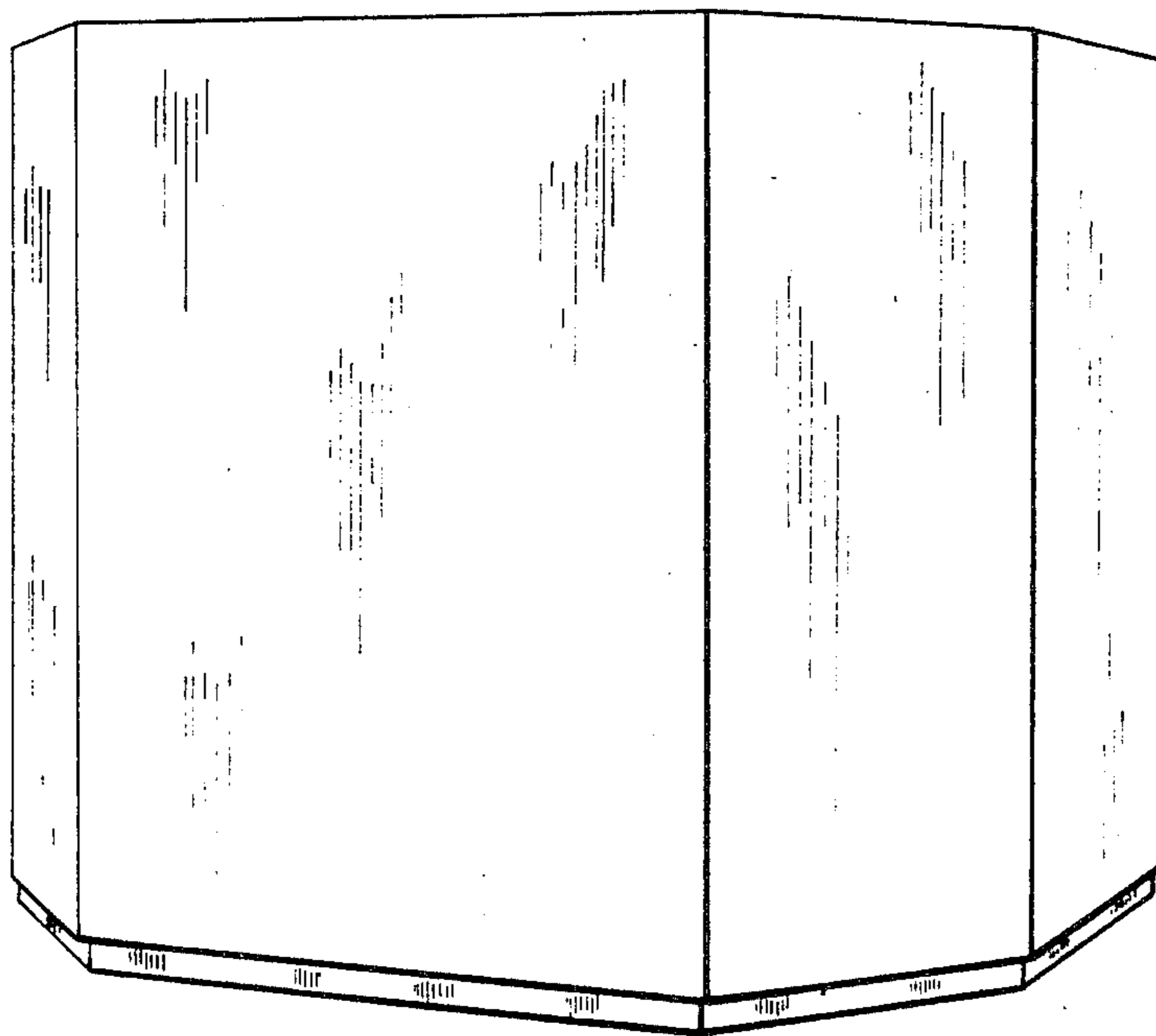

FIG. 2.

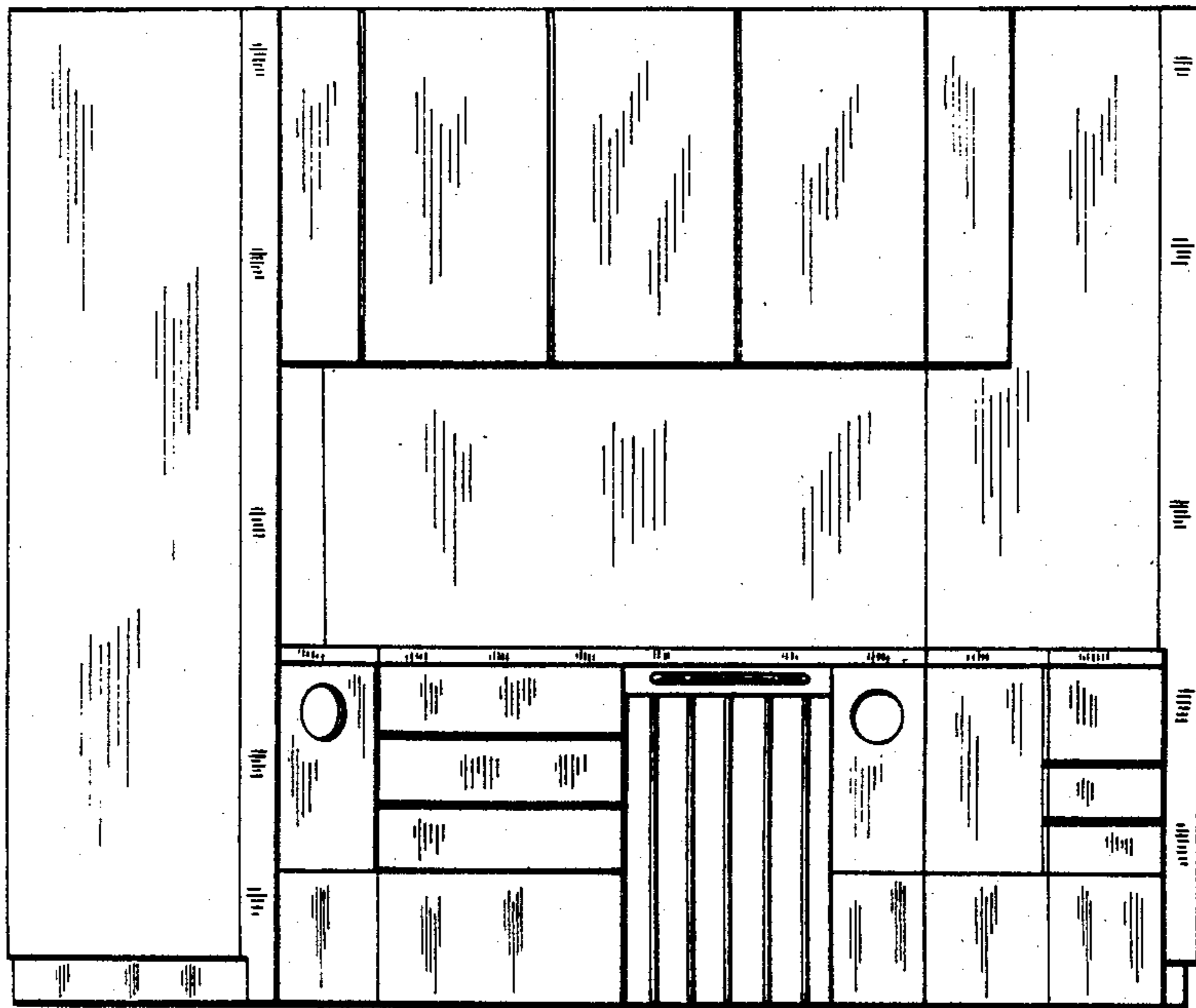

FIG. 3.

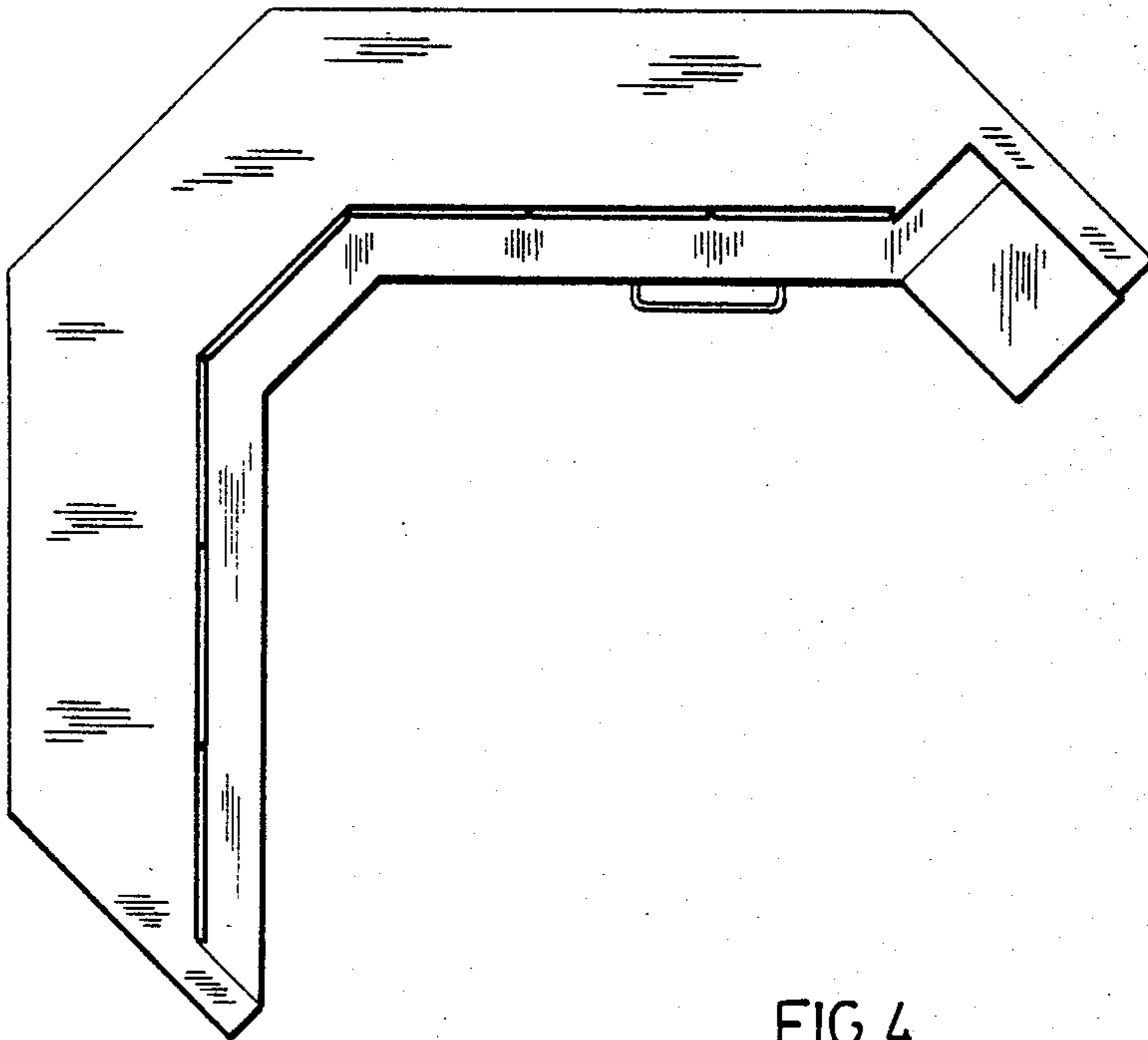

FIG. 4.

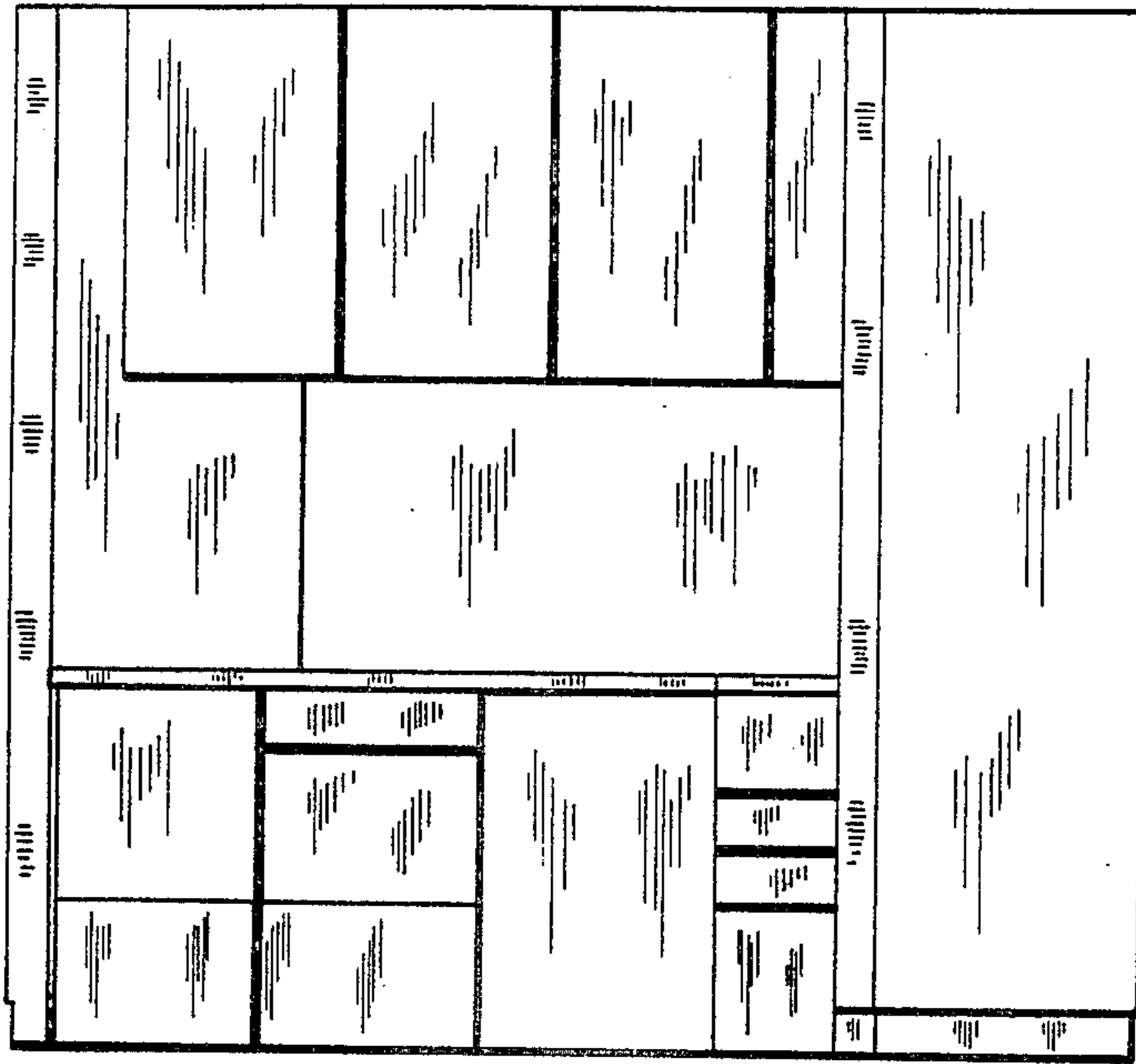

FIG. 5.

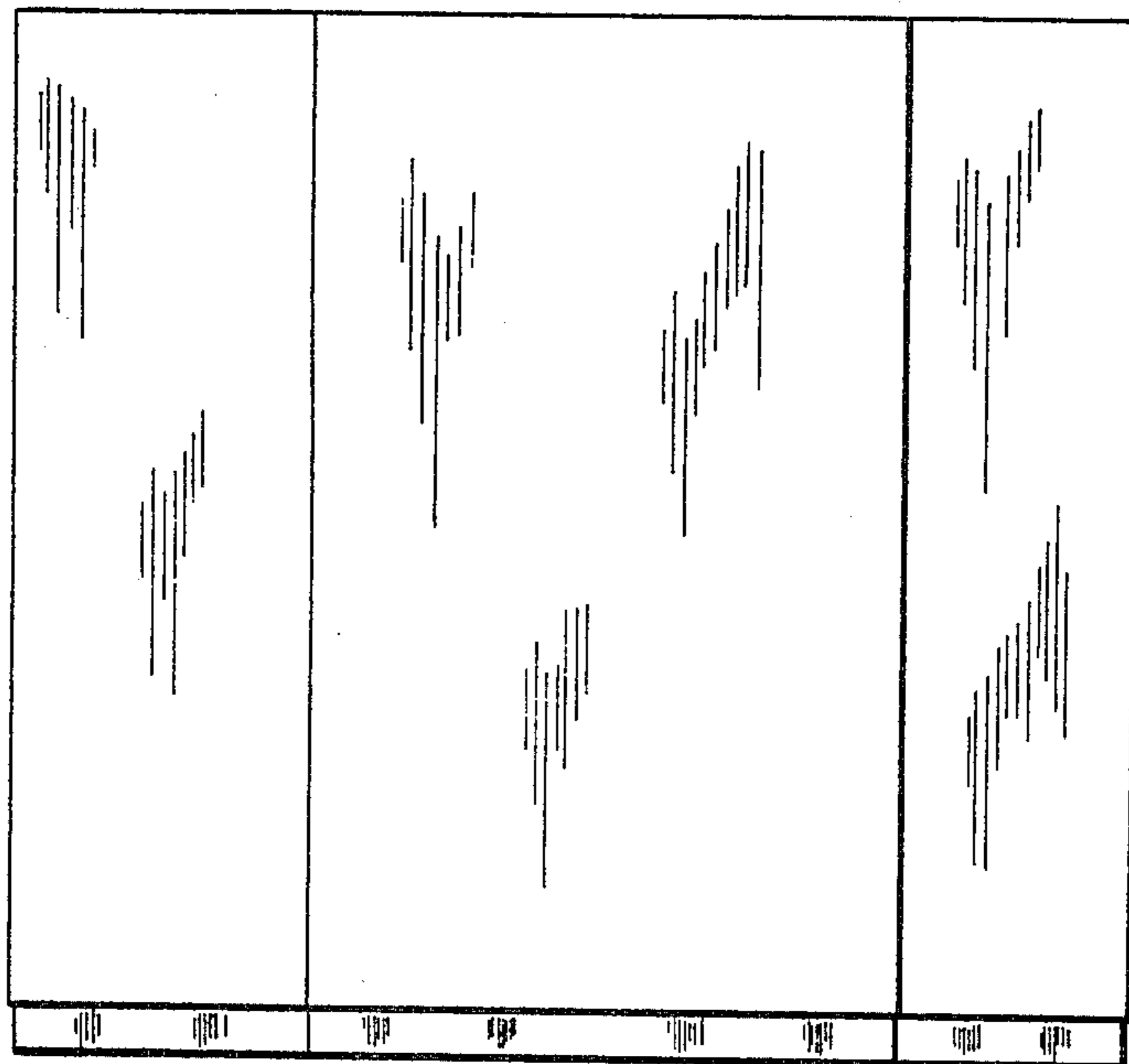

FIG. 6.

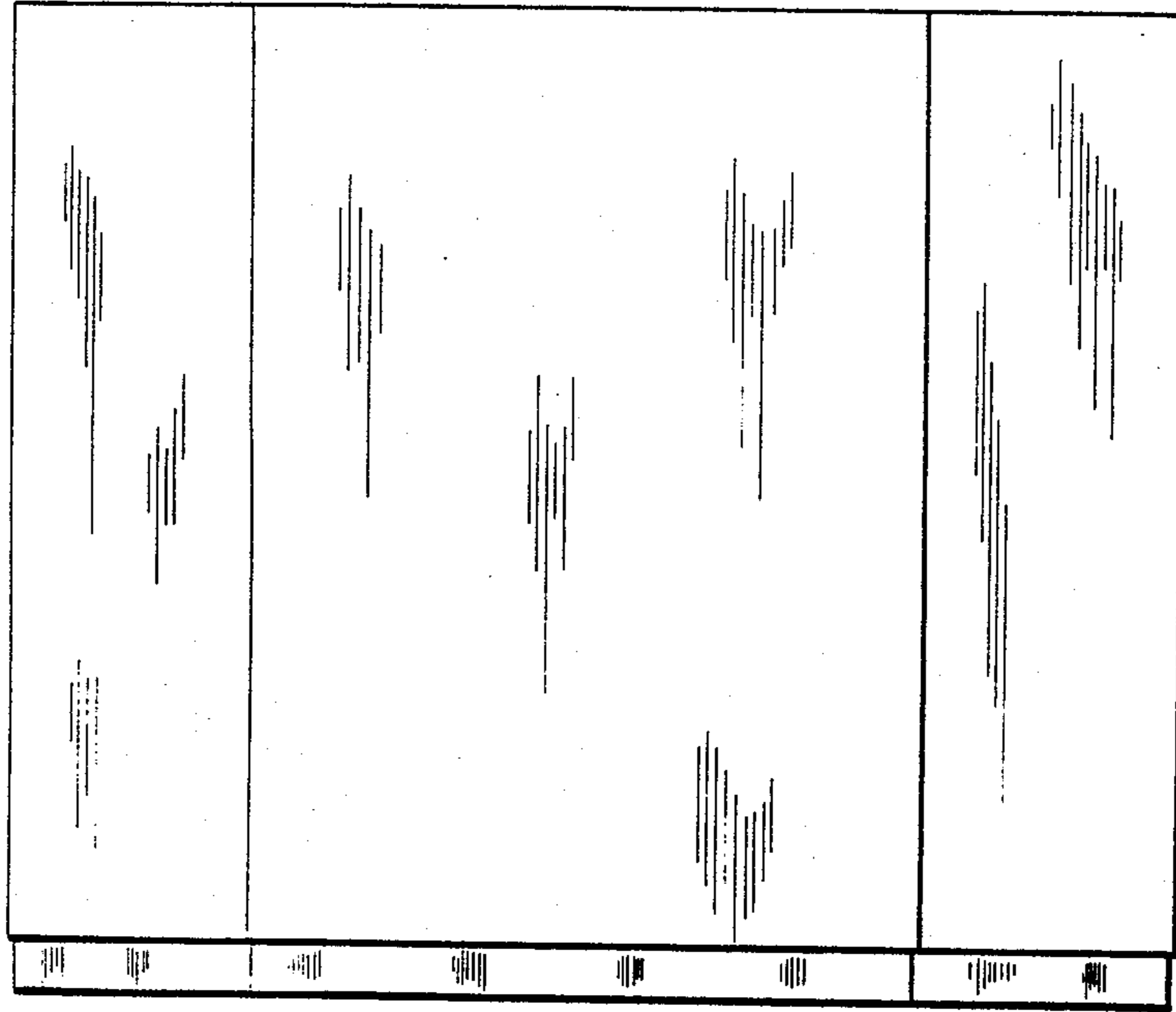

FIG. 7.

