

[54] PEN

[75] Inventor: Robert Adell, Novi, Mich.

[73] Assignee: U.S. Product Development Company, Sunnyvale, Tex.

[\*\*] Term: 14 Years

[21] Appl. No.: 379,581

[22] Filed: May 19, 1982

[52] U.S. Cl. .... D19/42; D19/46; D19/49; D19/57

[58] Field of Search ..... D19/35, 36, 41-51, D19/57, 75-84, 97; D7/5; D21/177

[56] References Cited

U.S. PATENT DOCUMENTS

- D. 160,436 10/1950 Seibert ..... D19/49
- D. 222,597 11/1971 Feuer ..... D19/42
- D. 224,846 9/1972 Feuer ..... D19/42
- D. 242,158 11/1976 Sterba ..... D21/177

Primary Examiner—George P. Word  
Attorney, Agent, or Firm—Stephenson & Boller

[57] CLAIM

The ornamental design for a pen, substantially as shown and described.

DESCRIPTION

FIG. 1 is a right side elevational view of a first embodiment of a pen showing my new design.  
 FIG. 2 is a front elevational view of the first embodiment.  
 FIG. 3 is a left side elevational view of the first embodiment.  
 FIG. 4 is a rear elevational view of the first embodiment.  
 FIG. 5 is a top plan view of the first embodiment.  
 FIG. 6 is a bottom plan view of the first embodiment.  
 FIG. 7 is a right side elevational view of a second embodiment of the pen showing my new design.  
 FIG. 8 is a front elevational view of the second embodiment.  
 FIG. 9 is a left side elevational view of the second embodiment.  
 FIG. 10 is a rear elevational view of the second embodiment.  
 FIG. 11 is a top plan view of the second embodiment.  
 FIG. 12 is a bottom plan view of the second embodiment.  
 FIG. 13 is a right side elevational view of a third embodiment of the pen showing my new design.  
 FIG. 14 is a front elevational view of the third embodiment.  
 FIG. 15 is a left side elevational view of the third embodiment.  
 FIG. 16 is a rear elevational view of the third embodiment.  
 FIG. 17 is a top plan view of the third embodiment; and  
 FIG. 18 is a bottom plan view of the third embodiment.

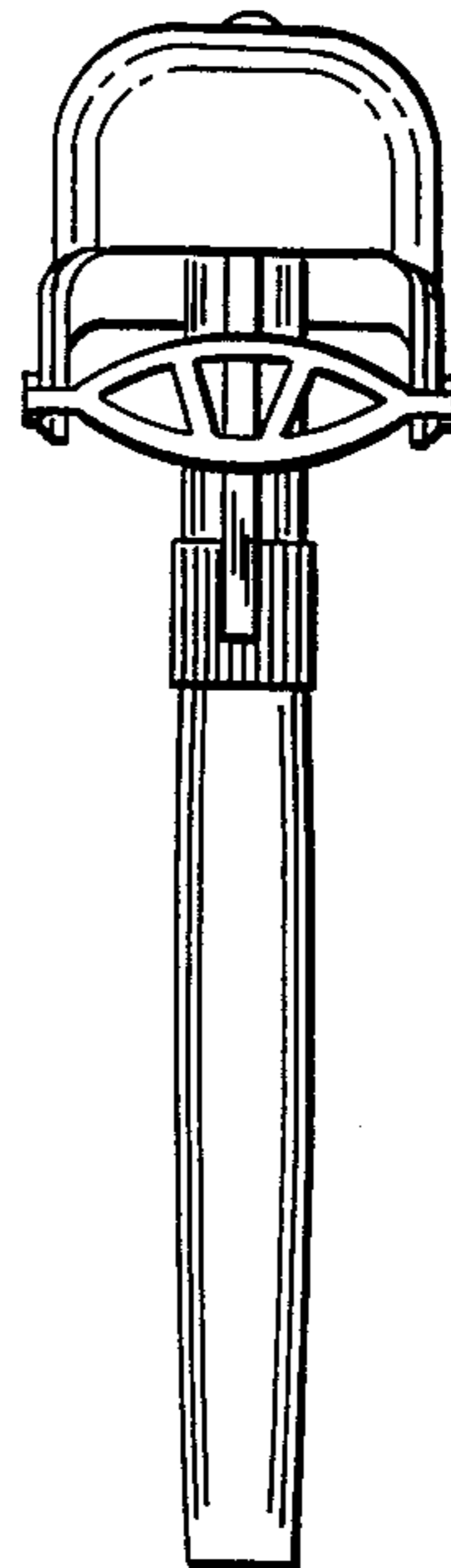
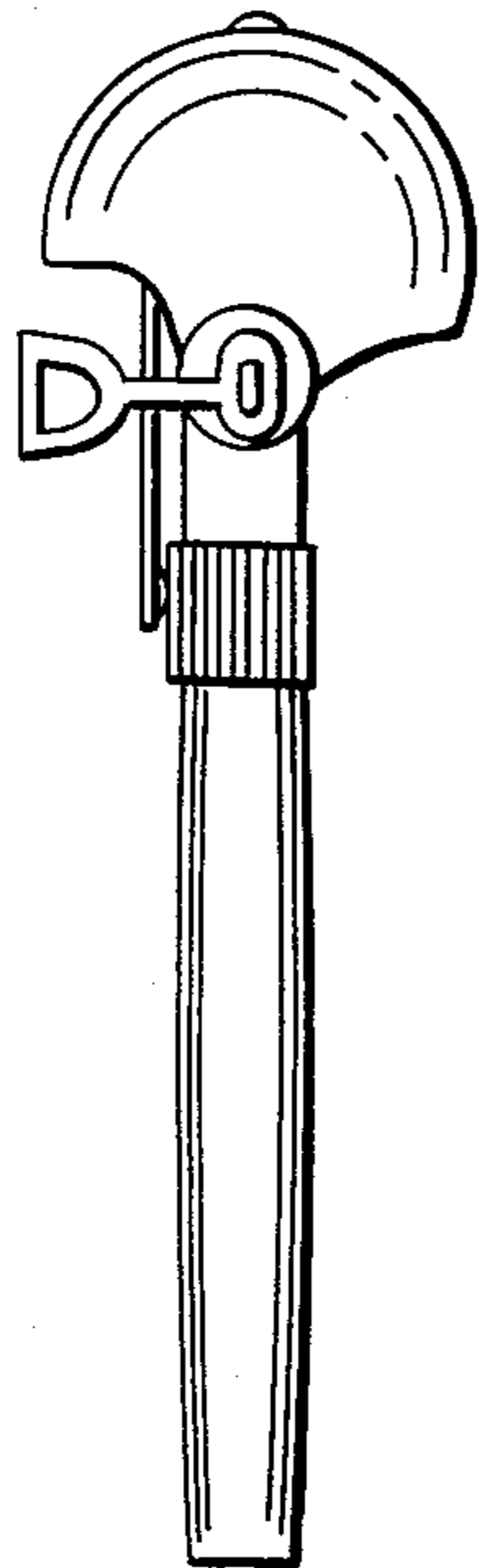

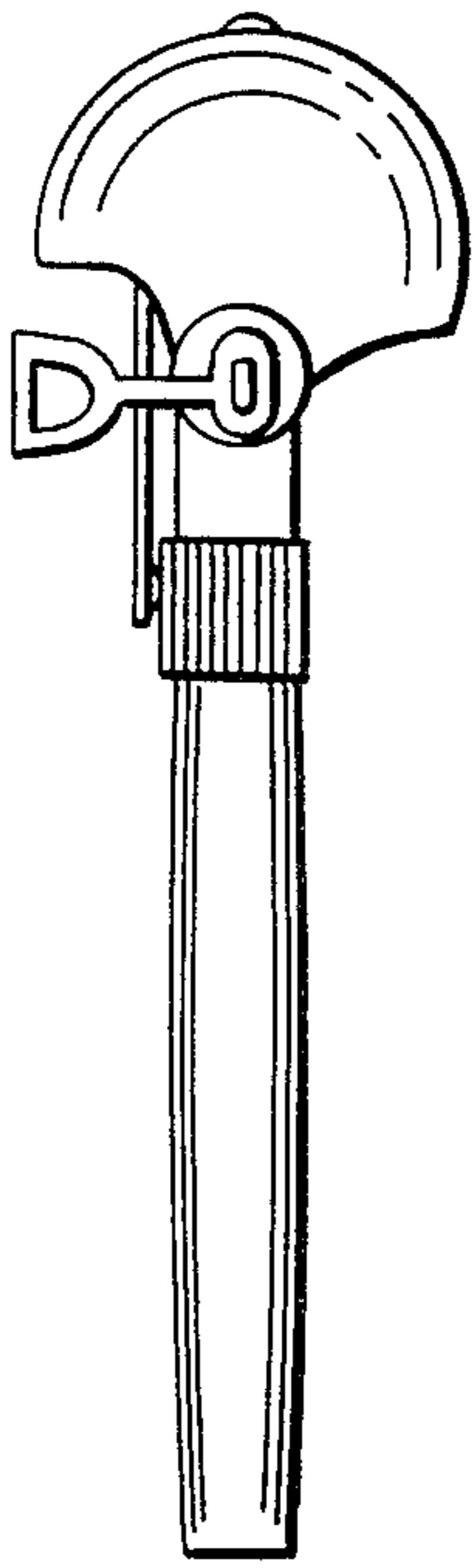

fig. 1

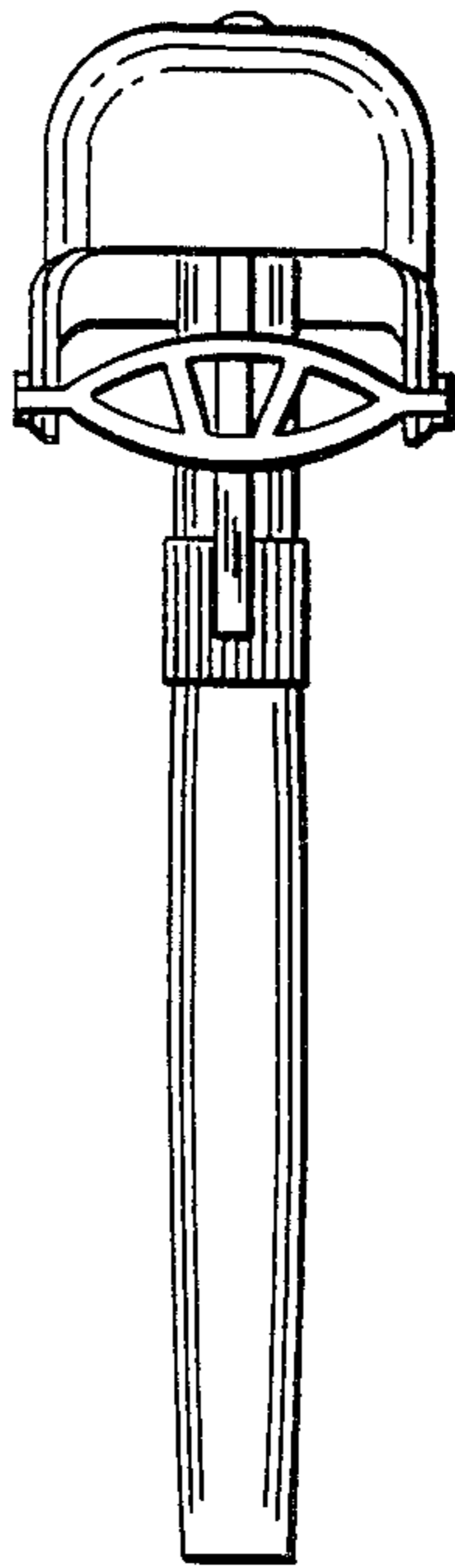

fig. 2

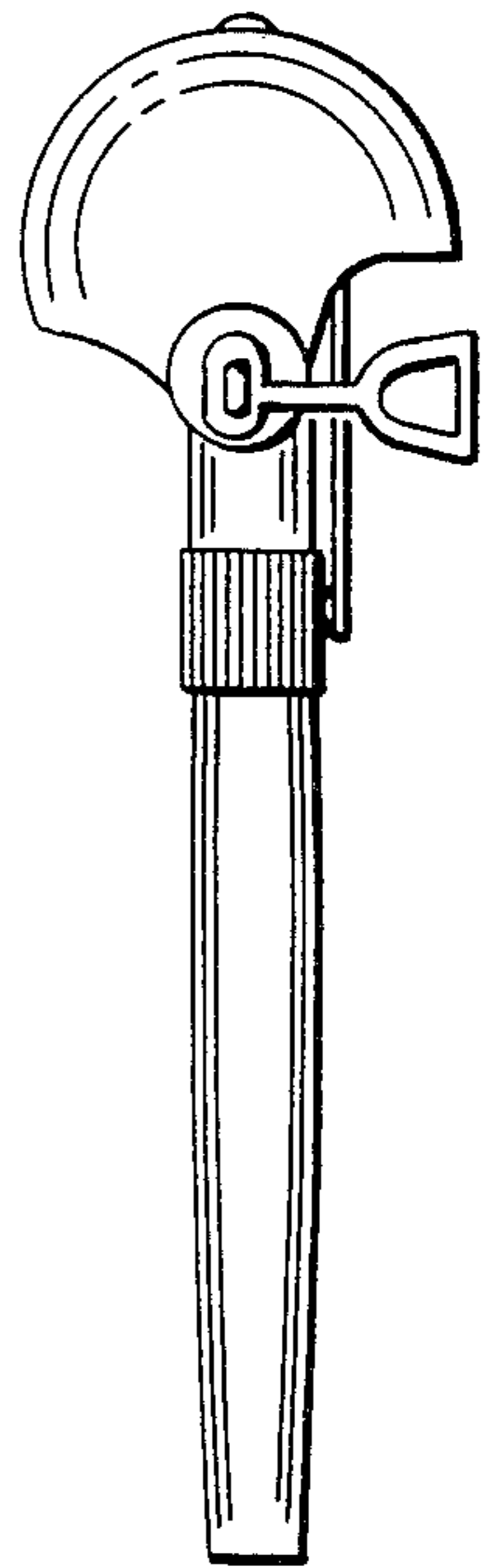

fig. 3

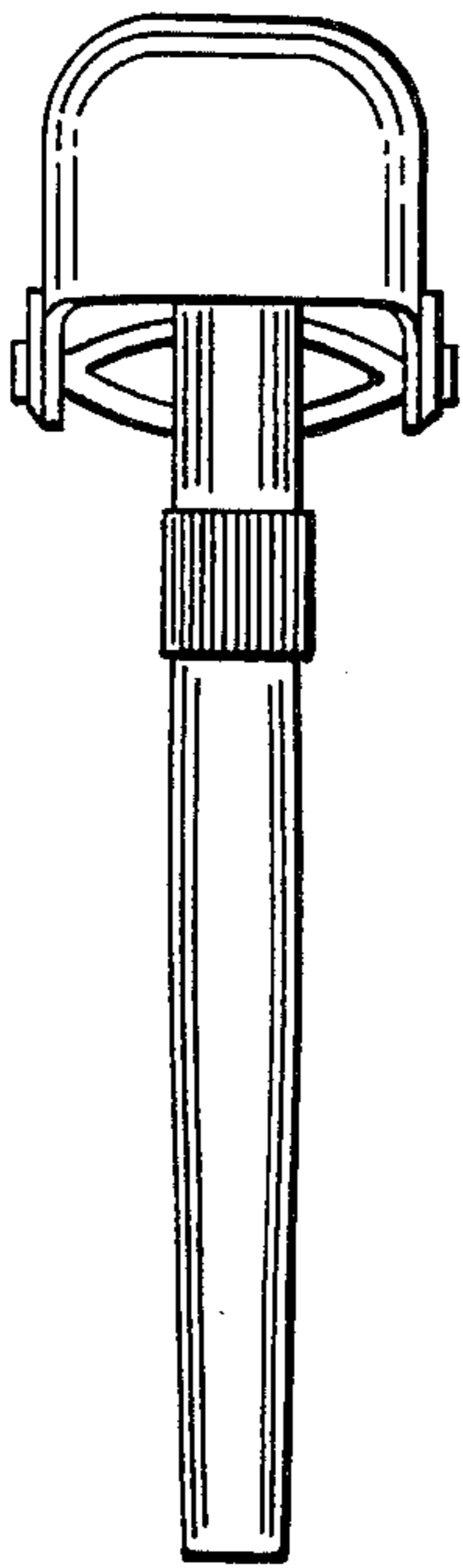

fig. 4

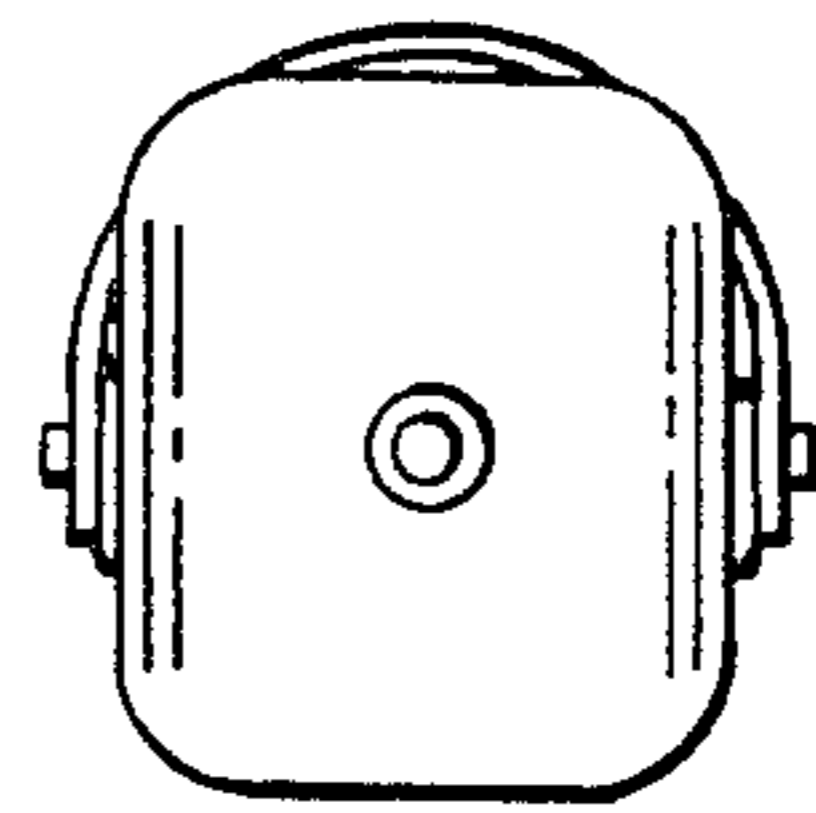

fig. 5

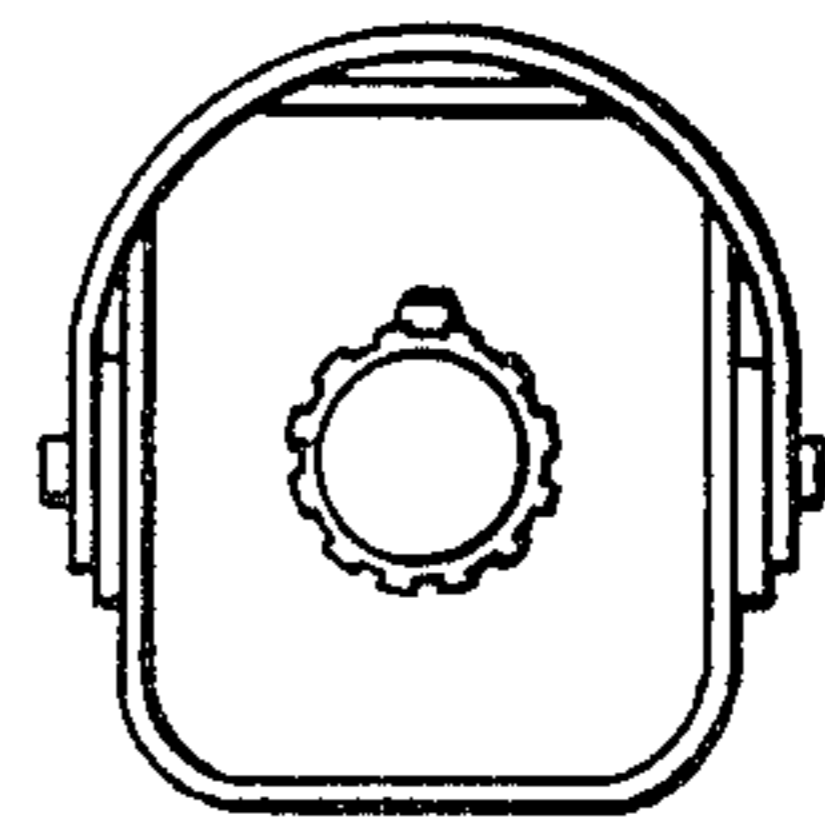

fig. 6

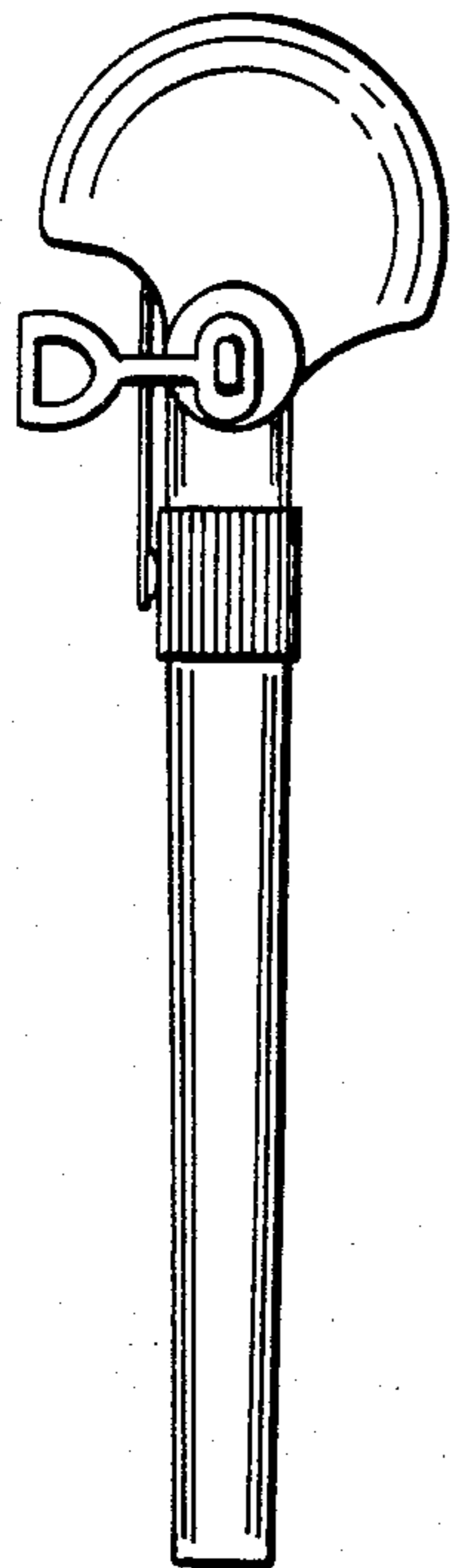

fig. 7

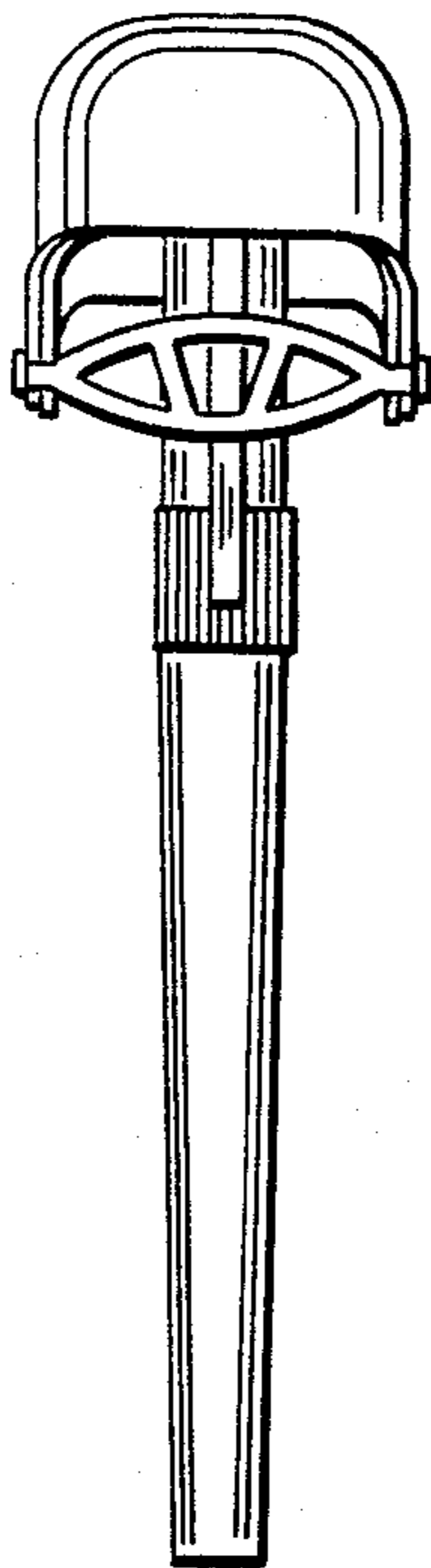

fig. 8

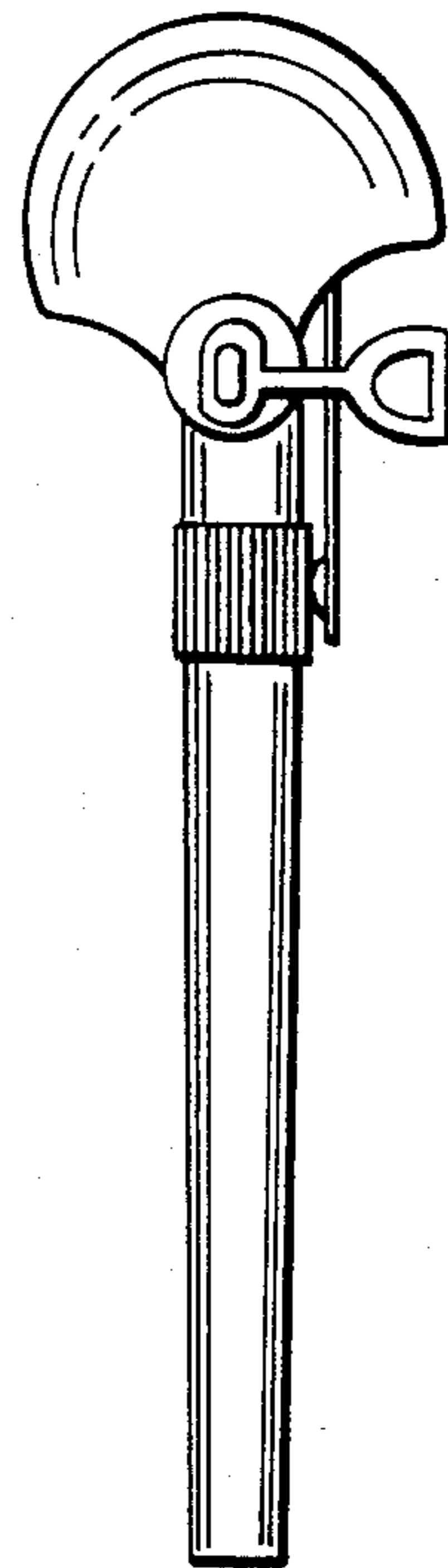

fig. 9

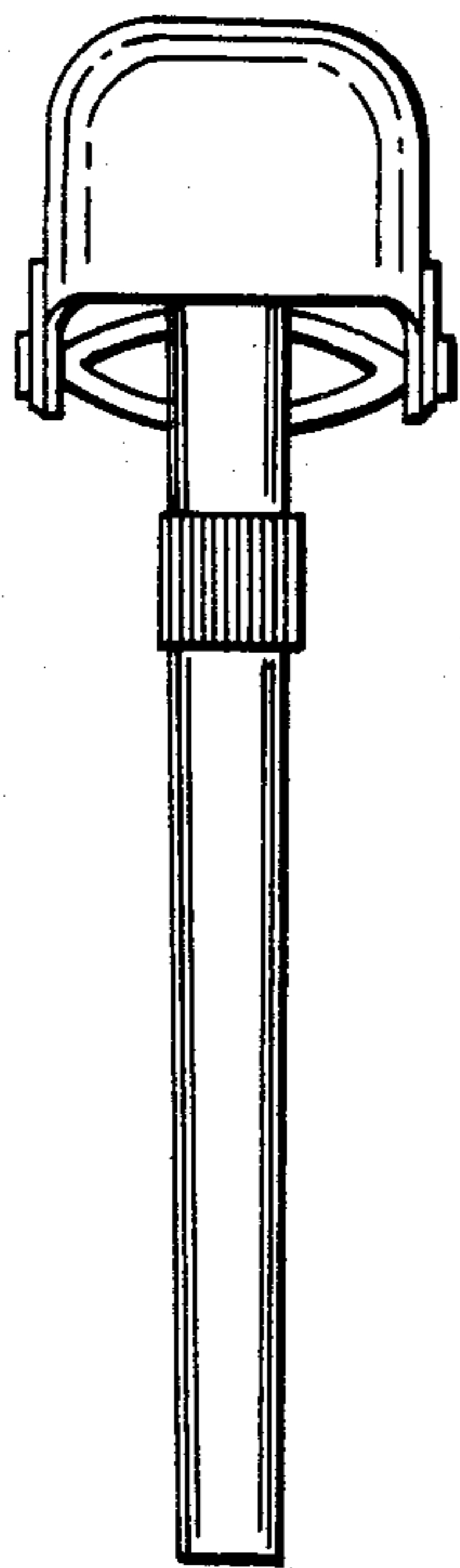

fig. 10

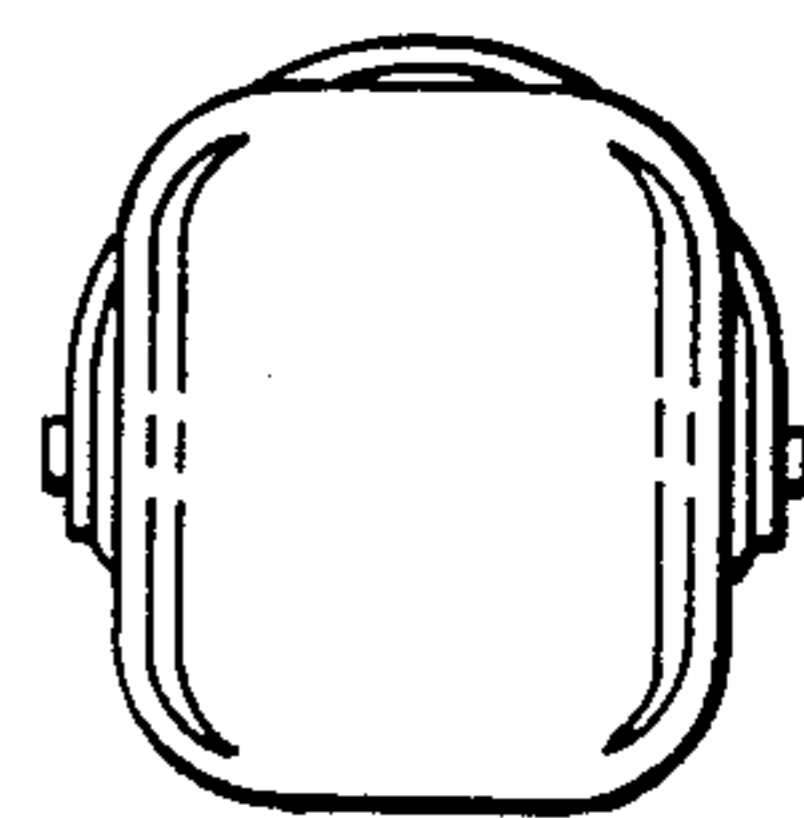

fig. 11

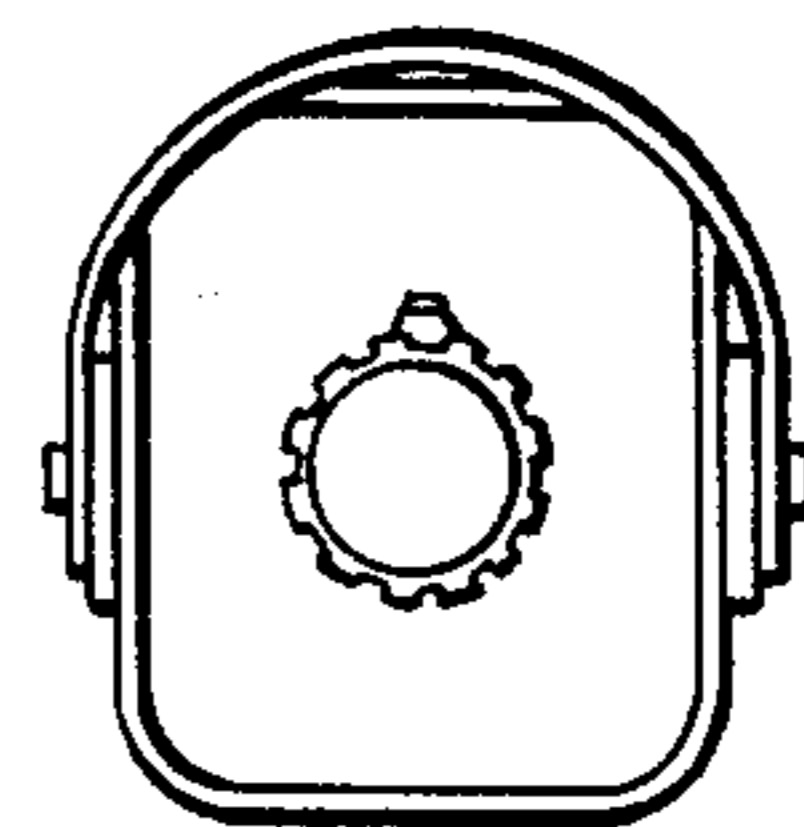

fig. 12

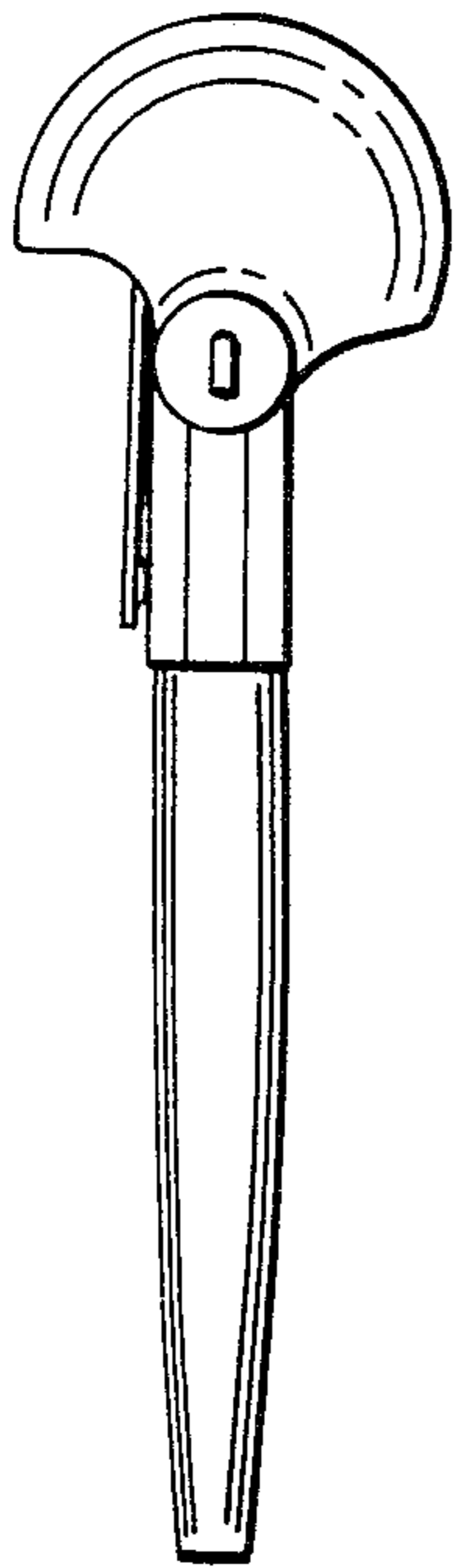

fig. 13

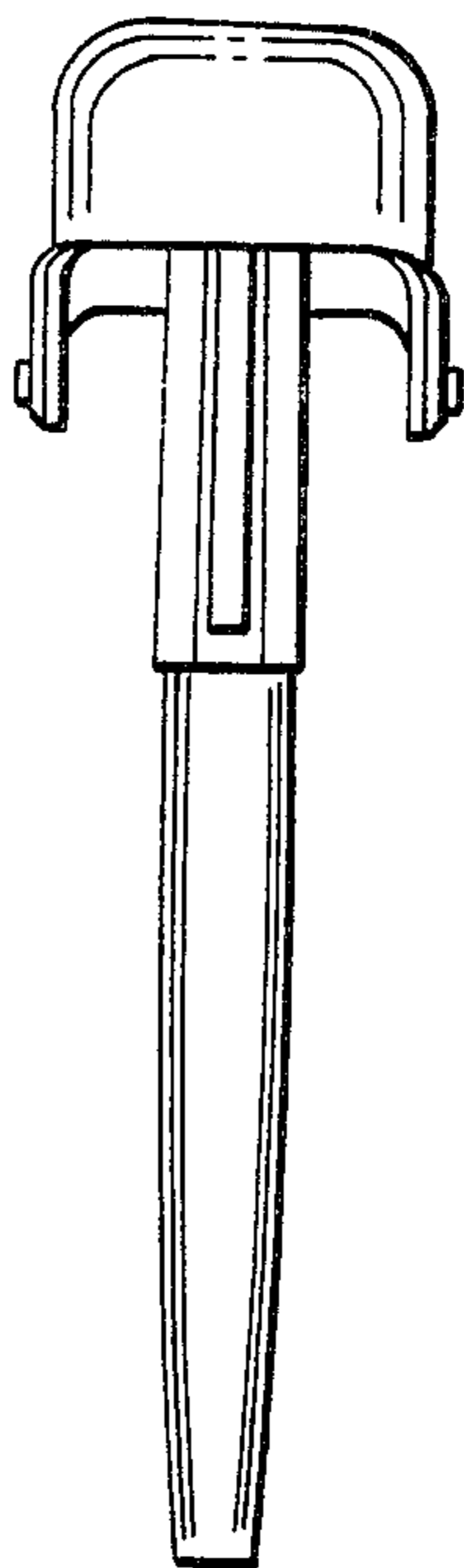

fig. 14

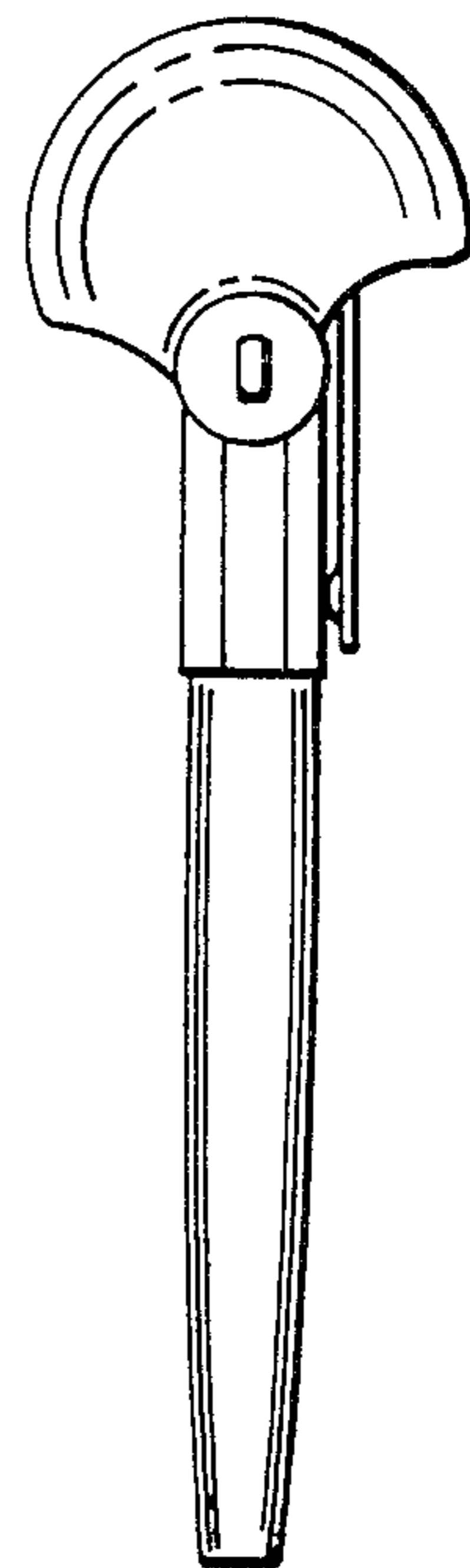

fig. 15

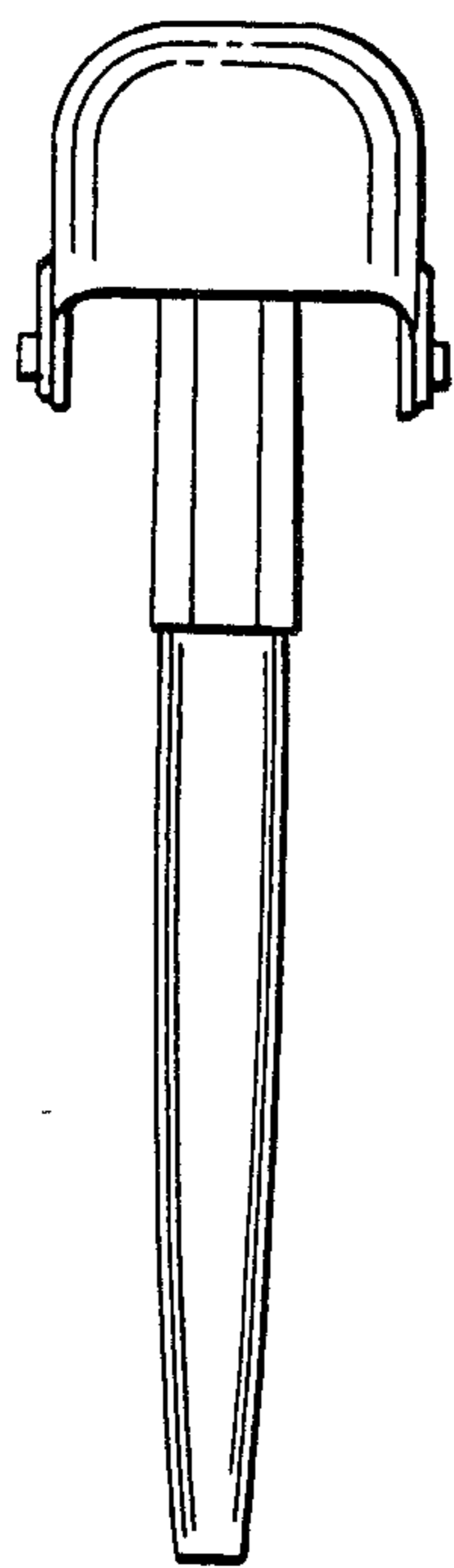

fig. 16

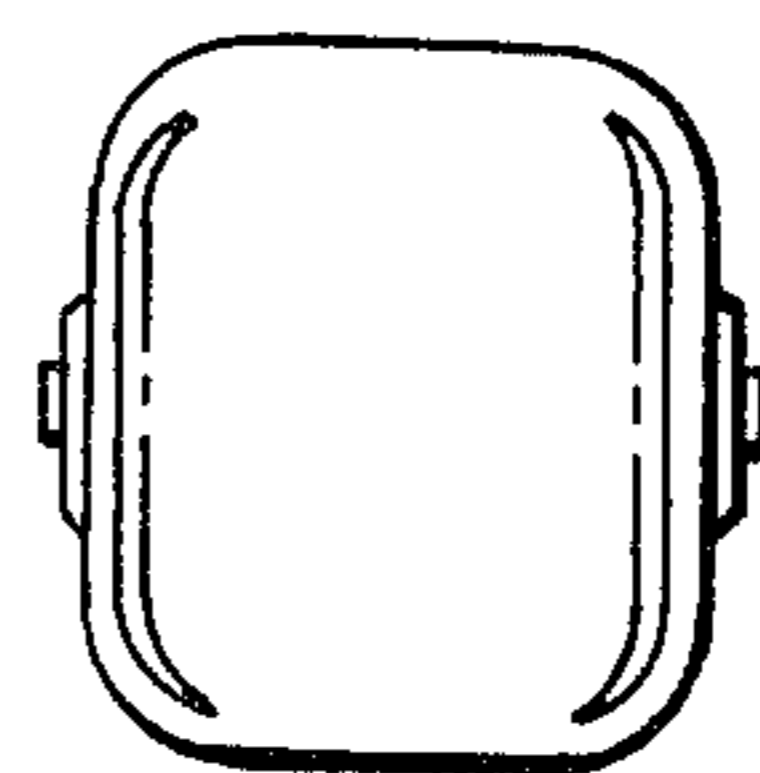

fig. 17

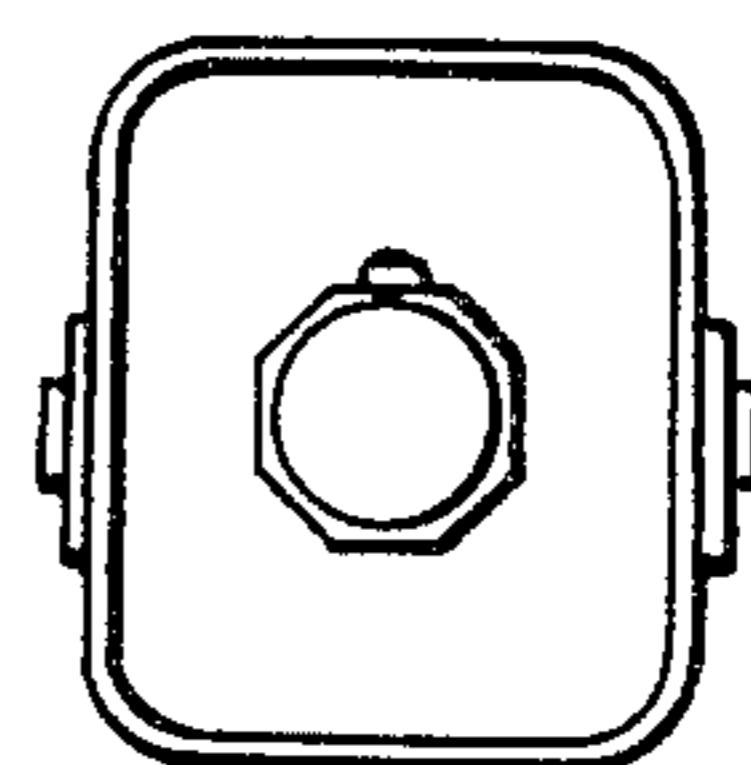

fig. 18