

[54] BOX FOR CULTIVATING VEGETABLES OR THE LIKE

[76] Inventor: Toshiro Kaneko, 20-3, Nakashinden, Yaizu-shi, Shizuoka-ken, Japan

[\*\*] Term: 14 Years

[21] Appl. No.: 556,079

[22] Filed: Nov. 29, 1983

[52] U.S. Cl. .... D11/155; D11/156

[58] Field of Search ..... D11/143-156; D7/37, 38; D34/40, 42, 44-46; 206/562, 563, 564; 47/66, 85-87

[56] References Cited

U.S. PATENT DOCUMENTS

|            |        |               |       |         |
|------------|--------|---------------|-------|---------|
| D. 224,366 | 7/1972 | Rehrig        | ..... | D34/44  |
| D. 247,025 | 1/1978 | Cherry        | ..... | D7/37   |
| D. 272,726 | 2/1984 | Kaneko        | ..... | D11/155 |
| 3,142,133  | 7/1964 | Brooks        | ..... | 47/86   |
| 3,386,608  | 6/1968 | Diller        | ..... | 47/86   |
| 3,810,329  | 5/1974 | Lecuru et al. | ..... | 47/87   |

FOREIGN PATENT DOCUMENTS

2074433 11/1981 United Kingdom ..... 47/87

Primary Examiner—B. J. Bullock  
Attorney, Agent, or Firm—Robert E. Burns; Emmanuel J. Lobato; Bruce L. Adams

[57] CLAIM

The ornamental design for a box for cultivating vegetables or the like, substantially as shown and described.

DESCRIPTION

FIG. 1 is a top plan view of a box for cultivating vegetables or the like showing my new design;  
FIG. 2 is a front elevational view thereof, the back being the same in appearance as the front;  
FIG. 3 is a bottom plan view thereof;  
FIG. 4 is a right side elevational view thereof, the left side being the same in appearance as the right side;  
FIG. 5 is a sectional view thereof taken in the direction of the arrows on line 5—5 of FIG. 1;  
FIG. 6 is an enlarged sectional view thereof taken in the direction of the arrows on line 6—6 of FIG. 5; and  
FIG. 7 is a sectional view thereof taken in the direction of the arrows on line 7—7 of FIG. 1.

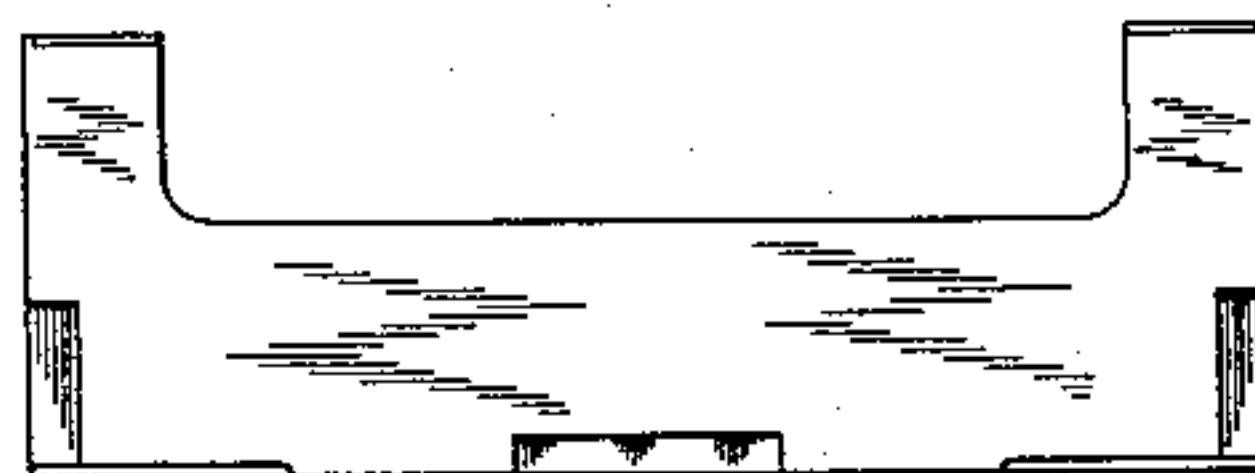
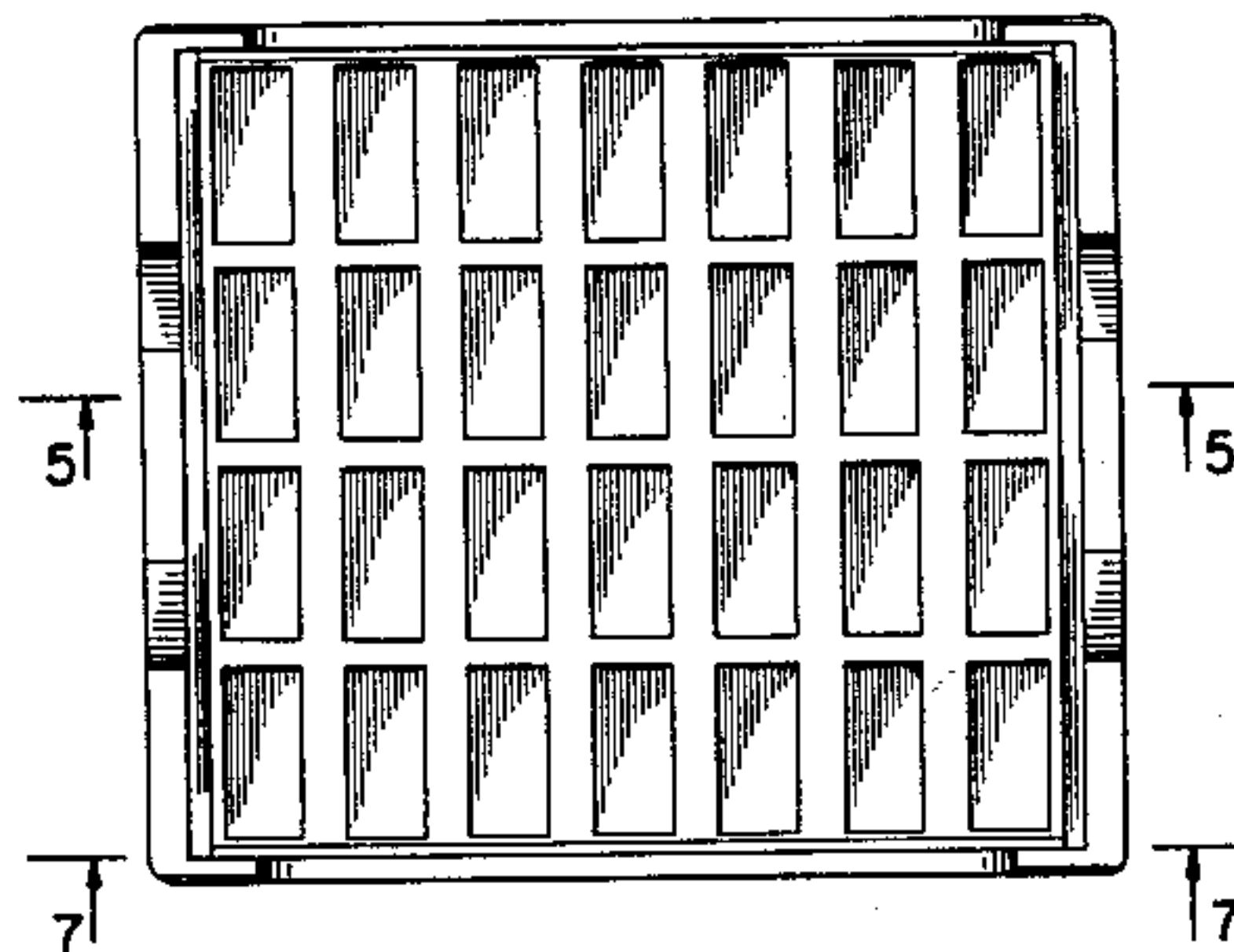

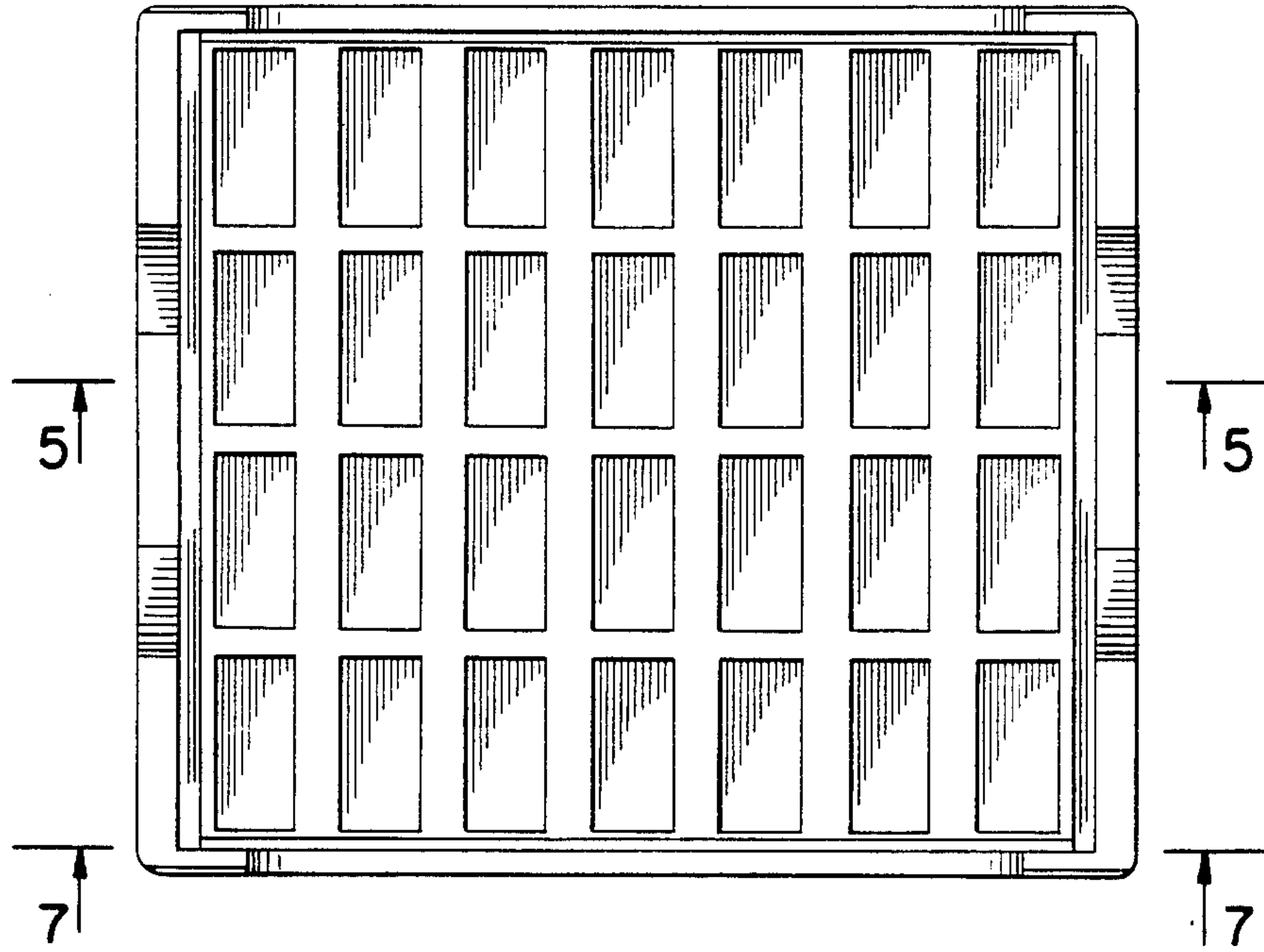

FIG. 1

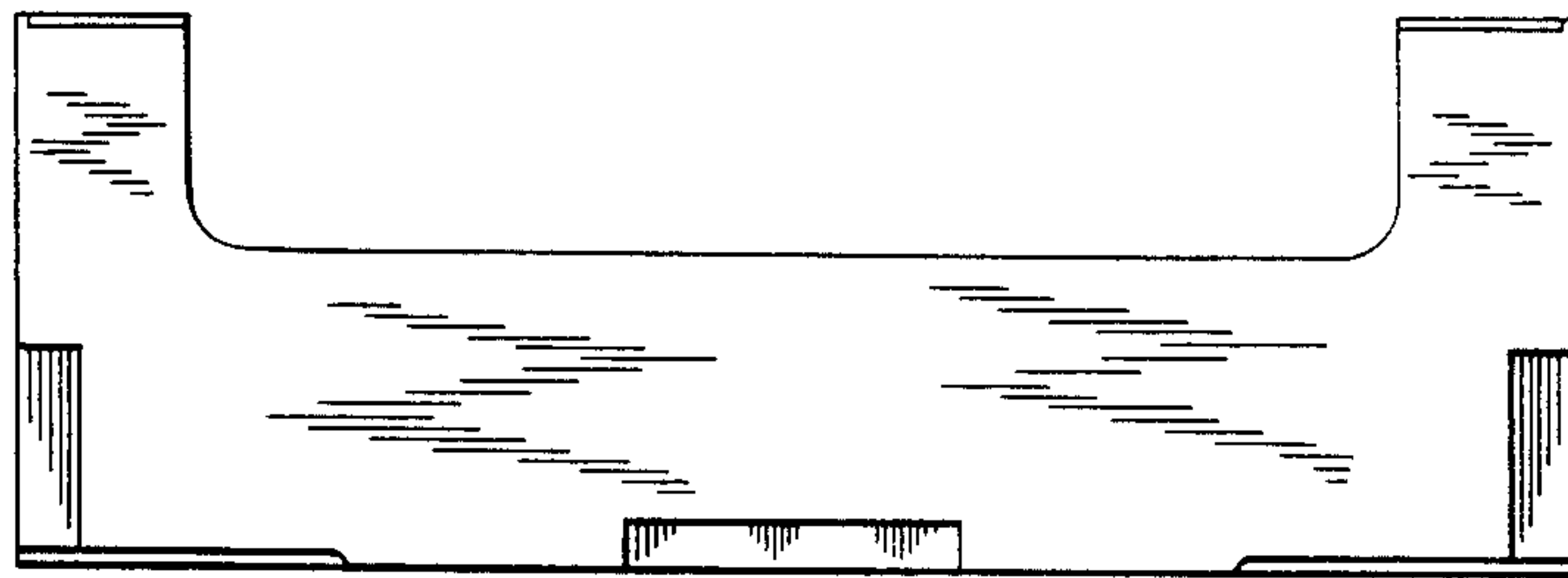
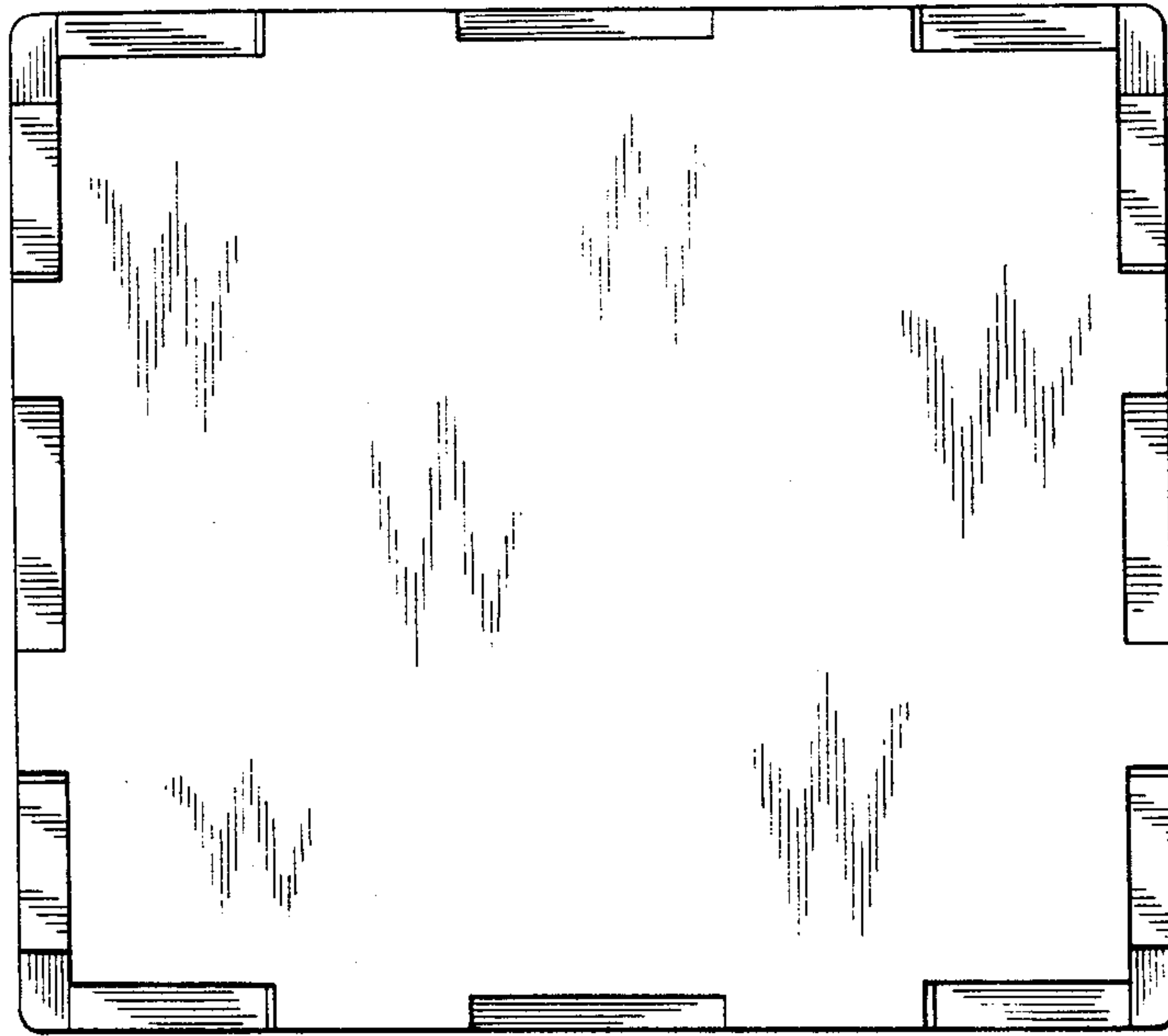
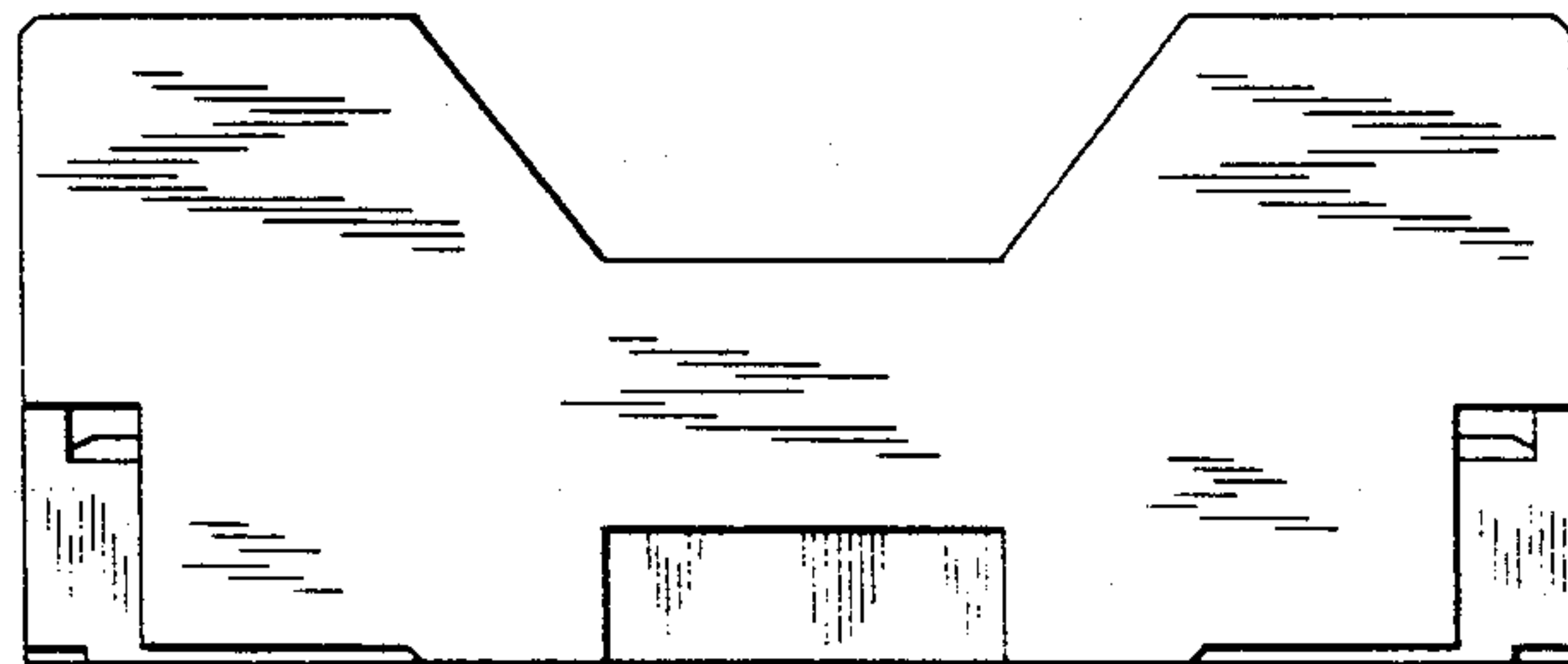

FIG. 2



*FIG. 3*



*FIG. 4*

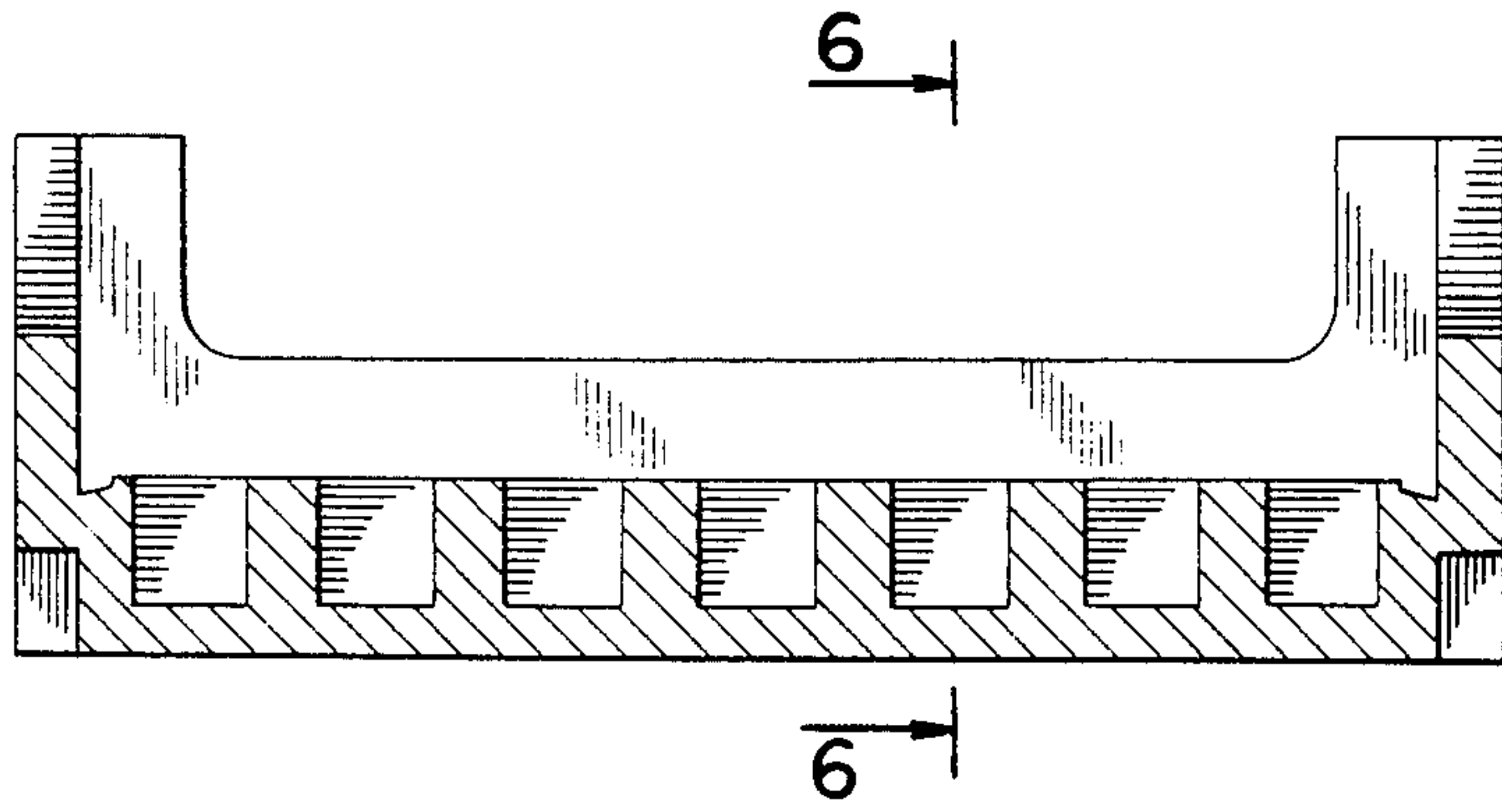

*FIG. 5*

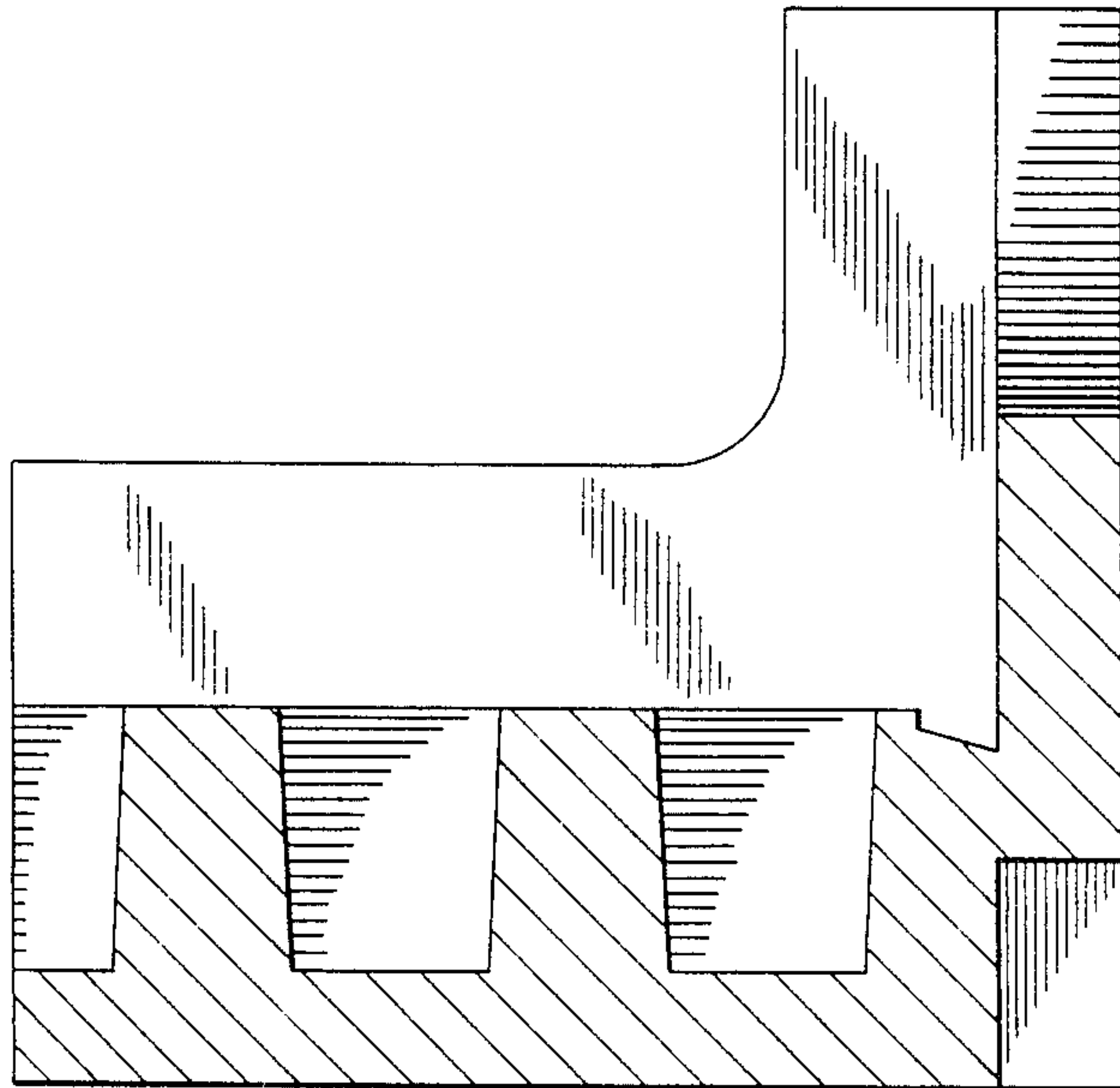

*FIG. 6*

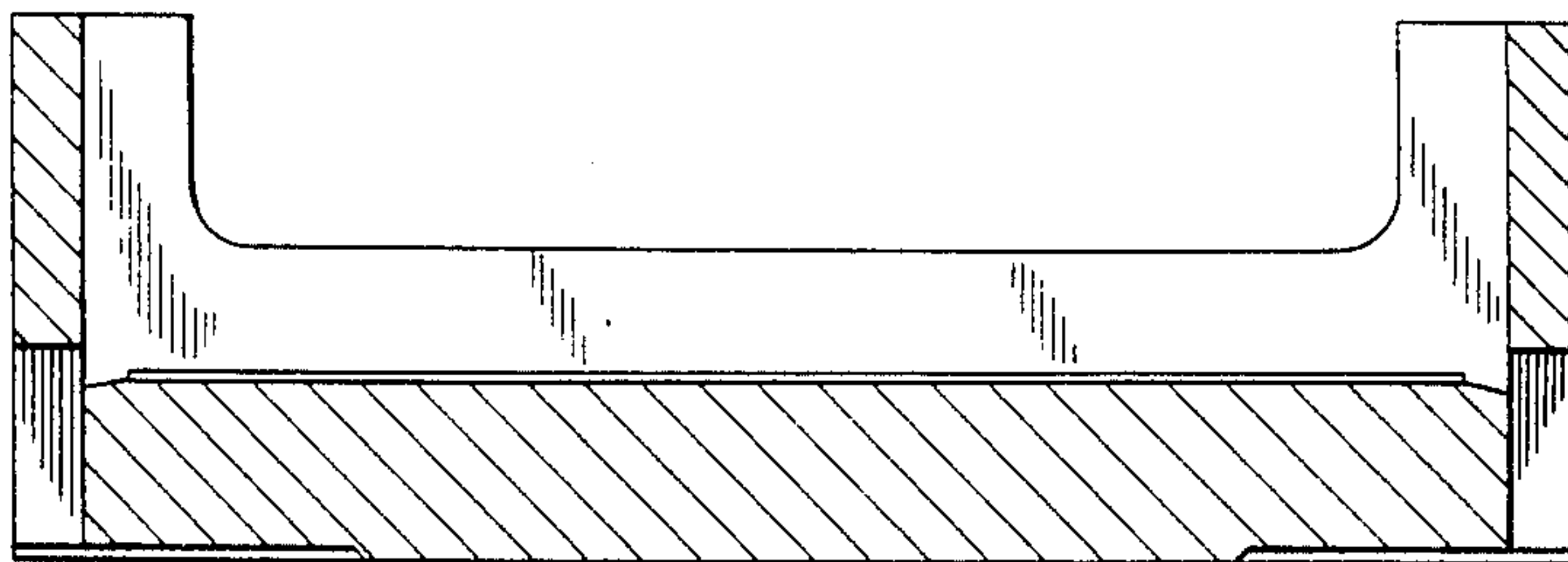

*FIG. 7*